

AE

# OPERATING INSTRUCTIONS DISHWASHER

**gorenje**



## Contents

---

Display panel .....	2
Important safety instructions .....	3
Before washing for the first time .....	4
Loading the dishwasher .....	5
Using the dishwasher .....	8
Settings .....	12
Care and maintenance instructions .....	14
Troubleshooting .....	16
Installation instructions .....	20
Service .....	22
Technical information .....	24

## Display panel

---

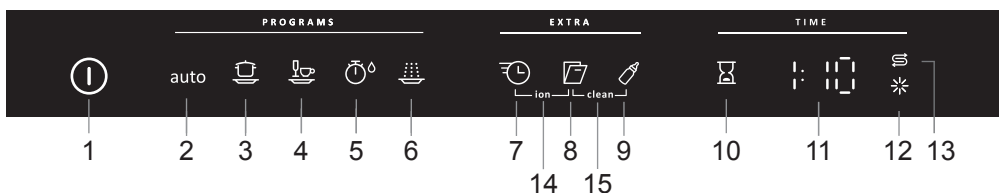

- |   |                   |    |                       |
|---|-------------------|----|-----------------------|
| 1 | Main power switch | 9  | Extra hygiene         |
| 2 | Auto wash         | 10 | Delayed start         |
| 3 | Intensive wash    | 11 | Display               |
| 4 | Normal wash       | 12 | Rinse aid indicator   |
| 5 | Quick wash        | 13 | Salt indicator        |
| 6 | Rinse             | 14 | ION                   |
| 7 | SpeedWash         | 15 | Self-cleaning program |
| 8 | Auto open         |    |                       |

## Important safety instructions

### SAVE THESE INSTRUCTIONS FOR FUTURE REFERENCE

#### **WARNING!**

When using your dishwasher, follow basic precautions, including the following:

- Read all instructions before using the dishwasher.
- Use the dishwasher only for its intended function.
- Use only detergents or wetting agents recommended for use in a dishwasher and keep them out of the reach of children.
- When loading items to be washed:
  - locate sharp items so that they are not likely to damage the door seal, and
  - load sharp knives with the handles up to reduce the risk of cut-type injuries.
- Do not wash plastic items unless they are marked “dishwasher safe” or the equivalent. For plastic items not so marked, check the manufacturer’s recommendations.
- Do not operate the dishwasher unless all enclosure panels are properly in place.
- Do not tamper with controls.
- Do not abuse, sit on, or stand on the door or dish rack of the dishwasher.
- To reduce the risk of injury, do not allow children to play in or on a dishwasher.
- Under certain conditions, hydrogen gas may be produced in a hot water system that has not been used for two weeks or more. **HYDROGEN GAS IS EXPLOSIVE.** If the hot water system has not been used for two weeks, before using the dishwasher turn on all hot water faucets and let the water flow from each for several minutes. This will release any accumulated hydrogen gas. As the gas is flammable, do not smoke or use an open flame during this time.
- Remove the door to the washing compartment when removing an old dishwasher from service or discarding it.
- Read the grounding instructions in the installation instructions.

### General

- Do not run the dishwasher while you are out of the home.
- Do not store or use combustible materials, gasoline, or other flammable vapors and liquids in the vicinity of this or any other appliance.
- Disconnect electrical power to dishwasher before servicing.
- Repairs should be done by a qualified technician.

#### **WARNING!**

This product may contain chemicals known to the state of California to cause cancer or reproductive harm.

### Installation

See the chapter Installation instructions.

### Child safety

#### **TIP!**

Dishwasher detergents and rinse aids are corrosive, so always keep them out of reach of children.

- Should a child swallow dishwasher detergent or rinse aid, give plenty to drink immediately, i.e., one or two glasses of milk or water. Do not try to induce vomiting. Seek medical advice immediately: Call the National Capital Poison Center at 1-800-222-1222.
- Always close the door and start the dishwasher as soon as you put in the detergent.
- Always keep small children away from the machine when it is open. There may be some detergent residue left inside the machine.
- If dishwasher detergent gets in someone’s eyes, rinse them with plenty of water for at least 15 minutes.

### Winter storage/transport

- Store the dishwasher where the temperature remains above freezing.
- Avoid long transport distances in very cold weather.
- Transport the dishwasher upright or laying on its back.

### Overflow guard function

The overflow protection starts pumping out the machine and turns off the water supply if the water level in the dishwasher exceeds the normal level. If the overflow protection is triggered, turn off the water supply and call the Customer Care Center.

### Packing material

The packaging protects the product during transport. The packaging material is recyclable. Separate the different packaging materials to help reduce raw material use and waste. Your dealer can take the packaging for recycling or direct you to the nearest recycling center. The packaging is comprised of:

- Corrugated cardboard made from up to 100% recycled material.
- Expanded polystyrene (EPS) with no added chlorine or fluorine.
- Supports made from untreated wood.
- Protective plastic made from polyethylene (PE).

### Disposal

- When the machine has reached the end of its service life and is to be disposed of, it should immediately be made unusable. Pull out the power cable and cut it as short as possible.
- The dishwasher is manufactured and labeled for recycling.
- Contact your municipality for information about where and how your dishwasher can be recycled correctly.

### The water softener

In order to achieve good dishwashing results, the dishwasher needs soft water (water with low mineral content). Hard water leaves a white coating on dishes and the dishwasher.

Water hardness is specified using the following scales: The German water hardness scale (°dH) and the French water hardness scale (°fH). A water supply with a water hardness in excess of 6°dH (9°fH) must be softened. This is done automatically with the aid of the built-in water softener. In order for the softener to function optimally, it must be adjusted to the hardness of the water supply.

Contact the local water utility to check the water hardness in your area.

### Adjusting the water softener

Chapter Settings on page 12 describes how to adjust the water softener.

### Fill up the salt

Before you begin using a dishwasher with a water softener, you must fill the salt compartment with salt for the water supply to be softened automatically. Use large grain salt or special dishwasher salt.

#### **WARNING!**

In order to avoid rust stains, a dishwashing program must be started immediately after adding salt.

Never pour dishwasher detergent into the salt compartment. This destroys the water softener!

#### **Do as follows the first time:**

- 1 Unscrew the lid as illustrated.
- 2 Insert the funnel supplied with the dishwasher in the salt compartment top-up hole. First, pour in about 0.3 gal (1 l) of water.
- 3 Then add salt, a maximum of 3 lb (1.5 kg), until the compartment is full.
- 4 Wipe up any excess salt so that the lid can be screwed on firmly.
- 5 Run a program to ensure that any salt in the dishwasher is rinsed away.

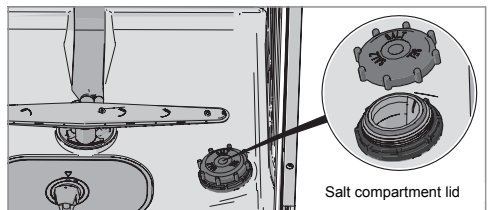

### Refill salt indicator

When the salt needs topping up, the above symbol lights on the display.

When the salt runs out, unscrew the cap and fill the container with salt. Water is only needed the first time! Wipe clean and tighten. Run a program to ensure that any salt in the dishwasher is rinsed away.

After topping up, it may take a while before the symbol goes out.

### Fill with rinse aid

Use rinse aid to improve wash and dry times. Also use rinse aid to achieve clear and spotless results.

- 1 Open the rinse aid compartment lid.
- 2 Carefully top up with rinse aid. Only add rinse aid to the level marked **max**.
- 3 Wipe up any spilled rinse aid around the compartment.
- 4 Close the lid firmly.

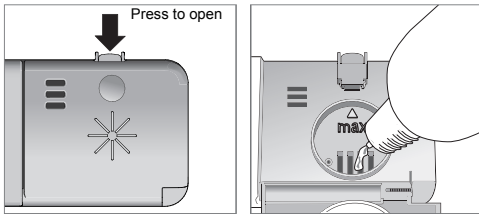

### Refill rinse aid indicator

When the rinse aid needs topping up, the above symbol lights on the display.

After topping up, it may take a while before the symbol goes out.

### Setting the rinse aid dosage

The chapter Settings describes how to set rinse aid amount. The rinse aid amount can be set from 0 (Off) to 5 (High dose). (Factory settings: 5)

#### Reduce the rinse aid dosage:

- If the dishes have a sticky white/blue film.
- If the dishes are streaked.
- Heavy foaming. If you have very soft water, the rinse aid can be diluted 50:50 with water.

### Energy-efficient dishwashing

- Do not start the dishwasher until it is fully loaded to save energy.
- Do not rinse under running water. Simply scrape off large food particles before loading the dishwasher.
- Choose an environmentally-friendly detergent. Read the environmental declaration on the packaging!
- If the dishes are only lightly soiled, you can select a program with a low temperature.
- Better drying results are achieved if you use the Auto open option, which automatically opens the dishwasher door at the end of the program. (If the dishwasher is built-in, the surrounding furnishings must be resistant to any condensation.)

### Fragile dishes

Some cookware is not dishwasher safe. This can be for several reasons. Some materials cannot withstand high temperatures, others can be damaged by dishwasher detergent.

Use caution with, for example, handmade items, fragile decoration, crystal/glassware, silver, copper, tin, aluminum, wood, and plastic. Look for the "Dishwasher safe" marking.

### The baskets

The dishwasher is equipped with a top cutlery tray, an upper basket, and a lower basket.

### Top cutlery tray

The top cutlery tray accommodates cutlery, ladles, whisks, and other utensils.

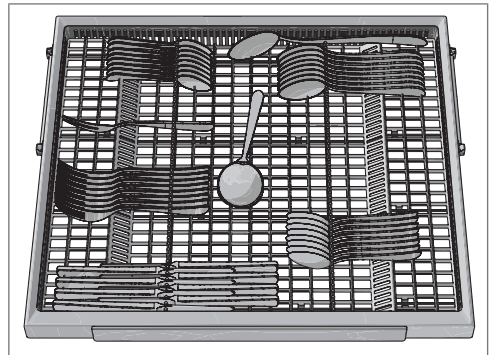

### Upper basket

Place glasses, cups, bowls, side plates, and saucers in the upper basket. Place all soiled surfaces face down! Place

wine glasses on the wine glass shelf. Place knives in the knife stand on the right (if space allows).

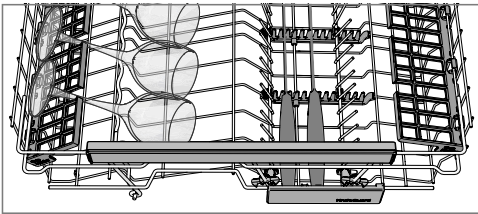
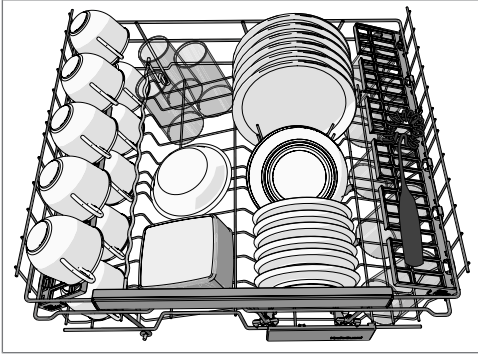

**Raising and lowering the upper basket**

- 1 Pull out the upper basket.
- 2 Grab the sides of the upper basket with both hands and lift it up.
- 3 Repeatedly lift the basket with both hands to change its position. (The upper basket can be set in three positions.) When the upper basket is in the highest position, lifting it will return it to the lowest position. Note that both sides of the basket must always be set to the same height.

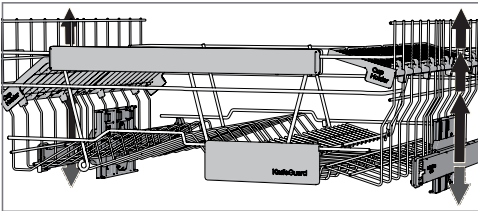

**Foldable tines**

The foldable tines can be folded up or down to make it easier to load pots, bowls, and glasses. Release the foldable

tines by pressing the catch inward before adjusting their position.

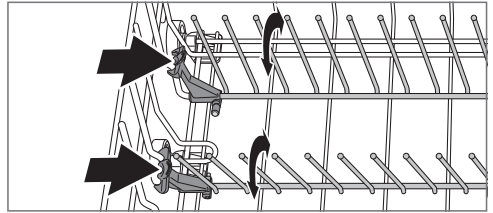

**Lower basket**

Place plates, side plates, serving dishes, and pots in the lower basket.

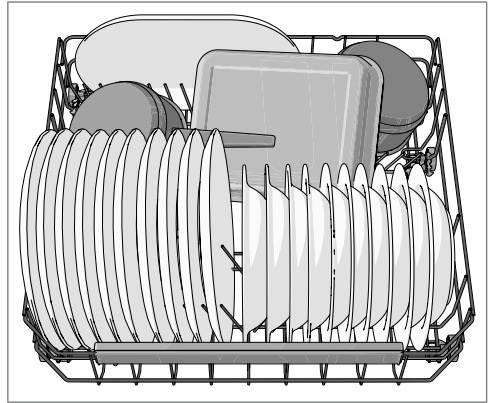

**Foldable tines**

Fold down the foldable tines when washing pots. Release the foldable tines by pressing the catch inward before adjusting their position.

**Points to consider**

- All dirty surfaces should face in and down!
- Dishes should not be placed in or on each other.
- Angle dishes with hollows, such as cups, so that the rinse water will run off. This is also important for plastic items.
- Place the upper basket in the highest position when large plates are being washed.
- Make sure small items cannot fall through the dishwasher basket; place them in the top cutlery tray.

**NOTE!**

Check that the spray arms can rotate freely.

**Typical load for 10 place settings**  
**Top cutlery tray with 10 place settings AHAM DW-1**

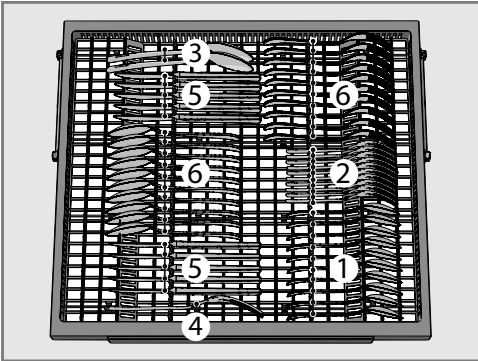

- 1 Teaspoons
- 2 Forks
- 3 Serving cutlery – spoons
- 4 Serving cutlery – fork
- 5 Knives
- 6 Soupspoons

**Lower basket with 10 place settings AHAM DW-1**

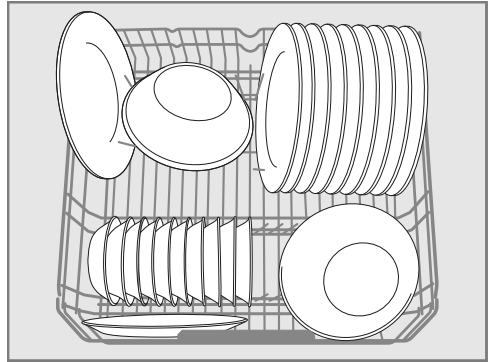

**Upper basket with 10 place settings AHAM DW-1**

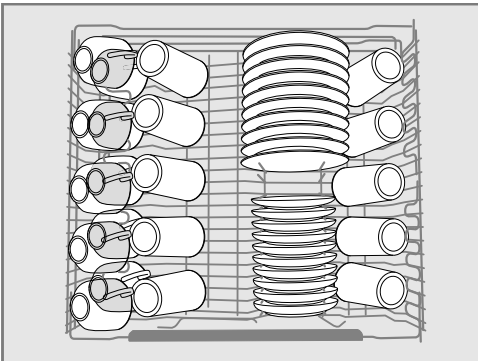

**NOTE!**

Ensure that the upper basket is set to its highest position.

## Using the dishwasher

### Add detergent

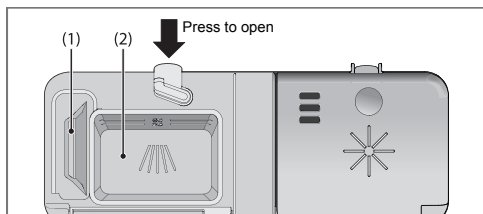

- 1 Prewash detergent compartment
- 2 Main wash detergent compartment

Detergent is added according to water hardness.

Follow the instructions on the detergent packaging. This dishwasher is fitted with a water softener, so use detergent and rinse aid doses suitable for soft water.

Too much detergent can result in less effective dishwashing and also entails greater environmental impact.

The detergent compartment must be dry when adding detergent. There is one compartment for the prewash and one for the main wash. If powder or liquid dishwasher detergent is used, add a small amount of the detergent to the prewash compartment. Contact the detergent manufacturer if you have questions about the detergent.

#### NOTE!

Use only dishwasher detergent! Liquid hand-washing detergent must not be used as the foam that forms prevents the dishwasher from operating effectively.

#### Dishwasher tablets

Halve the tablet if it is difficult to close the dispenser lid. There is a risk that the detergent will not be released properly if the lid is tight and cannot open correctly.

#### NOTE!

Dishwasher tablets are not recommended for short programs (less than 75 minutes). Use powder or liquid dishwasher detergent instead.

#### 3-in-1/All-in-one detergent

Chapter Settings describes how to activate TAB (3-in-1/all-in-one detergent). The salt compartment must be filled with salt. If you are not satisfied with the washing or drying results, deactivate the setting TAB (3-in-1/all-in-one detergent) and fill salt, detergent, and rinse aid. See Chapter Before washing for the first time.

Read through the directions for these products carefully. If anything is unclear, contact the detergent manufacturer.

- 1) This combination (Auto wash + SpeedWash + Auto open) is also known as QuickIntensive (90 minutes).

### The main power switch

Press and hold the main power switch until the display turns on. Also check that the water supply valve is on.

### PROGRAMS - Choose program

Choose a program to suit the type of dishes and how dirty they are.

Press the desired program until the program symbol is activated.

#### auto Auto wash

The dishwasher can measure how dirty the dishes are and adjust water consumption and temperature accordingly. When newly installed, the program needs to be run five times before it is fully adapted and can provide the best results.

#### auto Auto wash<sup>1)</sup> + SpeedWash + Auto open

An effective program for daily use with slightly dried leftovers. (This program is not intended for burnt food, such as on oven dishes.)

#### Intensive wash

Program for heavily soiled dishes, such as pans, casserole dishes, and oven dishes. If these dishes do not completely fill the dishwasher, you can add plates and other dishes that can withstand a Heavy wash to fill out the load.

#### Normal wash

This program is recommended for daily, regular, or typical use to completely wash a full load of normally soiled dishes, such as plates, serving dishes, cups, and glasses. No options are recommended.

#### Quick wash

This program is used for glasses and porcelain that is lightly soiled, such as coffee cups.

*In combination with SpeedWash, a shorter program is achieved (15 minutes).*

#### Rinse

Use to rinse dishes while you wait for the dishwasher to become fully loaded.

### EXTRA - Selecting Options

To select an option, press one of the option buttons until the option is activated. The available options vary between



programs and some options cannot be combined (available options glow dimly).

### **SpeedWash**

This option shortens the program time, but uses more energy and water.

### **Auto open**

The dishwasher door opens automatically at the end of the program, which improves the drying results. (If the dishwasher is built-in, the surrounding furnishings must be resistant to any condensation.)

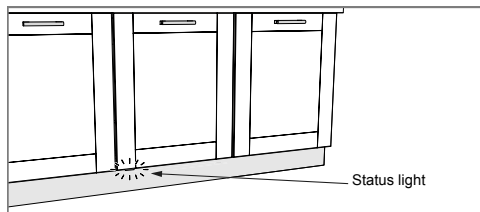

## Stopping or changing a program

If you want to change program after starting the dishwasher, open the door then press and hold the main power switch until the display turns off. Add more detergent if the lid of the detergent dispenser has opened. Then press the main power switch again to choose a new program.

### **NOTE!**

The dishwasher door must not be blocked when set to open automatically. This can disrupt door lock functionality.

### **Extra hygiene**

This option is intended for items with particularly high sanitation requirements, such as baby bottles and cutting boards. The temperature is increased in both the main wash and the final rinse.

### **Delayed start**

When you select Delayed start, the dishwasher will start 1-24 hours after you close the door.

- 1 Press the button once to activate Delayed start. Press the button several times – or hold it in – to set the desired number of hours.
- 2 Close the door and the dishwasher display counts down 1 hour at a time and starts after the selected delay.

If you want to cancel the Delayed start option, open the door and press and hold the main power switch until the display turns off.

## Starting the dishwasher

Press and hold the desired program until the program symbol starts to flash. Close the door within four seconds to start the dishwasher.

## TIME - Time remaining

Once you have chosen a program and options, the time the program took when last used is displayed.

## Status light

The status light on the bottom part of the dishwasher indicates that a program has started.

### **Flashing light**

This indicates a fault. See further in the chapter Troubleshooting.

### **WARNING!**

The dishwasher door must not be open while a program is in progress. If the door is open, "STR" is shown on the display. If you want the dishwashing program to continue, press any button and close the door immediately. If you want to cancel the dishwashing program, press and hold the main power switch until the display turns off.

## If the dishwasher is turned off due to a power failure

If the program was not finished, the interrupted program resumes when power is restored.

### **NOTE!**

During drying, the program is interrupted if the power is cut or the door is open for more than 2 minutes.

## How to get the best drying results

- Fully load the dishwasher.
- Angle dishes with hollows, such as cups, so that the rinse water will run off. This is also important for plastic items.
- Top up with rinse aid or increase the rinse aid dosage level.
- Activate the Auto open option.
- Allow the dishes to cool before unloading the dishwasher.

## Once the program has finished

The end of the program is indicated by one short signal from the buzzer. The chapter Settings describes how to change this function.

Moreover, the end of the program is indicated by the status light turning off. See Status light in the chapter Using the dishwasher.

The dishwasher switches off automatically after the program ends.

To minimize the risk of leaks, we recommend that you turn off the water supply valve if away from home for an extended period of time.

## Unloading the dishwasher

Hot porcelain is more fragile. Leave the dishes to cool in the dishwasher before unloading them.

Unload the lower basket first to avoid any water drops from the upper basket falling onto the dishes in the lower basket.

## Special programs

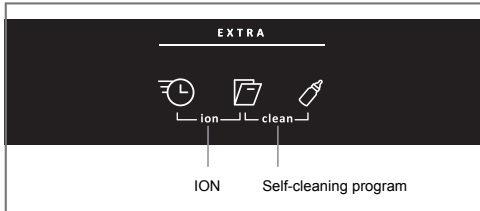

Press and hold the appropriate option buttons to activate a special program. The program starts when the door is closed.

## ION

This program prevents bad odors from dirty dishes left in the dishwasher. Activate the program until a dishwashing program is run. The fan and ionizer are activated at intervals for 72 hours. (Do not use this program in confined spaces with insufficient ventilation).

### TIP!

If you want to deactivate the ION program to start a dishwashing program, open the door then press and hold the main power switch until the display turns off. Restart the dishwasher.

## Self-cleaning program

Self-cleaning program for sanitizing the dishwasher tub, spray arms, and spray pipes.

This program can be run (with no dishes in the machine) using regular dishwasher detergent or citric acid. Special dishwasher cleaners are also available in stores. For the removal of limescale deposits, see The dishwasher tub in the chapter Care and maintenance instructions.

## Program chart

PROGRAMS - Program	Detergent, compartment 1 / 2 (ml)	EXTRA - Options	Prewashes	Main wash	Number of rinses	Final rinse	Consumption values <sup>1)</sup>		
							Dishwashing time (approx. hrs.:min)	Energy (approx. kWh)	Water cons. (L)
Auto wash	--- / 25	Auto open	2-3	50-65 °C 120-150 °F	2-3	65 °C 150 °F	2:40-3:15	1.01-1.06	14-20
Intensive wash	10 / 25		2	70 °C 160 °F	2	65 °C 150 °F	3:40	1.7	17
Normal wash <sup>2)</sup>	--- / 25	Auto open	3	50 °C 120 °F	2	50 °C 120 °F	2:20	0.87	13.0
Quick wash	--- / 10			35 °C 95 °F	1	25 °C 80 °F	0:20	0.2	10
Rinse	--- / ---				1	--- °C --- °F	0:07	0.01	3

1) Consumption values vary depending on the temperature of the incoming water, room temperature, load size, selected additional functions, and more.

2) The energy label performance figures are based on this program. This program is recommended for daily, regular, or typical use to completely wash a full load of normally soiled dishes, such as plates, serving dishes, cups and glasses. No options are recommended.

# Settings

## Open the settings menu:

1. First, open the door. Turn off the machine. Press and hold the main power switch until the display lights up.
2. Within 10 seconds:
  - press the program button for Auto wash and the option button for SpeedWash.
3. The display shows the settings menu (current setting and its currently set value).  
(Exit the menu by browsing through the menu or pressing the main power switch.)

## Navigate the settings menu:

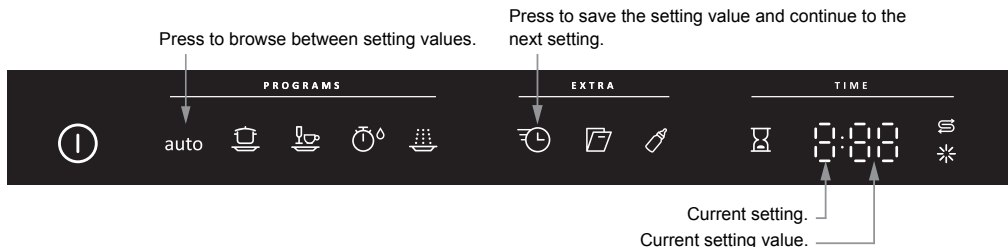

## You can now adjust the following settings:

Settings	Options																																					
1. Rinse aid	1:00 - 1:05	<p>Rinse aid dosage setting.</p> <p>Increase the rinse aid dosage:</p> <ul style="list-style-type: none"> <li>• If the dishes have water marks.</li> </ul> <p>Reduce the rinse aid dosage:</p> <ul style="list-style-type: none"> <li>• If the dishes have a sticky white/blue film.</li> <li>• If the dishes are streaked.</li> <li>• Heavy foaming. If you have very soft water, the rinse aid can be diluted 50:50 with water.</li> </ul>																																				
2. Water hardness	2:00 - 2:09	<p>Adjusting the water softener. Read off the appropriate setting from the water hardness table below.</p> <table border="1" style="width: 100%; text-align: center;"> <thead> <tr> <th>°dH</th> <th>°fH</th> <th></th> <th>°dH</th> <th>°fH</th> <th></th> </tr> </thead> <tbody> <tr> <td>0-5</td> <td>0-9</td> <td>➤ 2:00</td> <td>20-24</td> <td>35-43</td> <td>➤ 2:05</td> </tr> <tr> <td>6-8</td> <td>10-14</td> <td>➤ 2:01</td> <td>25-29</td> <td>44-52</td> <td>➤ 2:06</td> </tr> <tr> <td>9-11</td> <td>15-20</td> <td>➤ 2:02</td> <td>30-39</td> <td>53-70</td> <td>➤ 2:07</td> </tr> <tr> <td>12-14</td> <td>21-25</td> <td>➤ 2:03</td> <td>40-49</td> <td>71-88</td> <td>➤ 2:08</td> </tr> <tr> <td>15-19</td> <td>26-34</td> <td>➤ 2:04</td> <td>50+</td> <td>89+</td> <td>➤ 2:09</td> </tr> </tbody> </table> <p>Do not forget to put salt in the salt compartment after you have set the water softener to 2:01 - 2:09.</p> <p><i>For a water supply with a hardness under 6°dH (9°fH), select 2:00. The water softener is deactivated and no salt is needed.</i></p>	°dH	°fH		°dH	°fH		0-5	0-9	➤ 2:00	20-24	35-43	➤ 2:05	6-8	10-14	➤ 2:01	25-29	44-52	➤ 2:06	9-11	15-20	➤ 2:02	30-39	53-70	➤ 2:07	12-14	21-25	➤ 2:03	40-49	71-88	➤ 2:08	15-19	26-34	➤ 2:04	50+	89+	➤ 2:09
°dH	°fH		°dH	°fH																																		
0-5	0-9	➤ 2:00	20-24	35-43	➤ 2:05																																	
6-8	10-14	➤ 2:01	25-29	44-52	➤ 2:06																																	
9-11	15-20	➤ 2:02	30-39	53-70	➤ 2:07																																	
12-14	21-25	➤ 2:03	40-49	71-88	➤ 2:08																																	
15-19	26-34	➤ 2:04	50+	89+	➤ 2:09																																	

Settings	Options	
<b>3. TAB</b> (3-in-1/all-in-one detergent)	3:00 (Off) 3:01 (On)	<p>You can activate this setting when using 3-in-1/all-in-one detergent. The dishwashing programs automatically adapt to provide the best possible dishwashing and drying results every time. If this setting is activated, there is no need to add rinse aid since this option disables rinse aid dispensing. It also reduces the amount of salt added to the water softener. Note that salt must be put in the salt compartment.</p> <div data-bbox="611 365 1056 555" style="border: 1px solid black; padding: 5px;"> <p><b>NOTE!</b></p> <p>In order to achieve good dishwashing results, it is essential to check which type of detergent or all-in-one product best suits your needs! Read the detergent packaging carefully for information on proper use. Always follow the directions for use or information on the detergent packaging!</p> </div>
<b>4. Buzzer volume</b>	4:00 - 4:03	<p>The dishwasher uses a buzzer to indicate when a program is finished or when a fault has occurred.</p>

### Coarse filter

The coarse filter traps larger food particles, which cannot get past the drain pump. Empty the coarse filter as necessary.

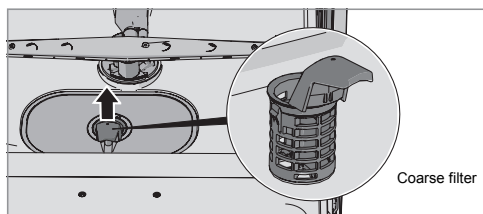

- 1 Lift the coarse filter by the handle.
- 2 Empty the coarse filter. Remember to replace it!

### Fine filter

Debris that collects on the fine filter is automatically rinsed away during each wash. Clean the fine filter when necessary.

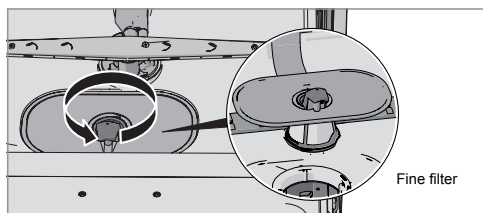

- 1 Turn the handle counterclockwise.
- 2 Lift the filter straight up using the handle. Remove the coarse filter to clean the fine filter.
- 3 Replace in reverse order. Check that the edges seal properly when replacing the fine filter.
- 4 Lock the filter in place by turning the handle clockwise to the stop position. The handle should point straight out from the dishwasher.

#### NOTE!

The dishwasher must not be used without the filters in place!

Dishwashing results may be affected if the coarse filter is incorrectly fitted.

### Spray arms

Holes and bearings can become blocked. Remove debris using a needle or similar item. The spray arms have holes on the bottom.

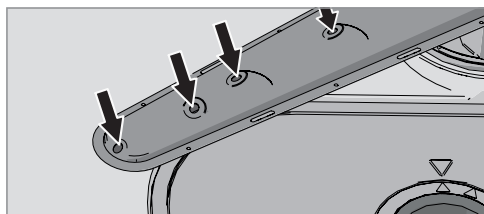

Spray arms can be removed for cleaning. Remember to fit them firmly back into place afterward.

#### Lower spray arm

- Pull the lower spray arm straight up to release it.

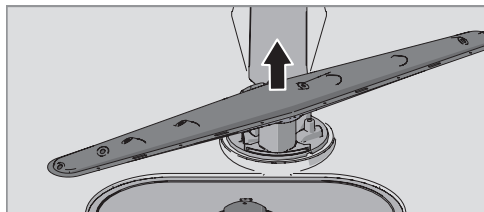

#### Upper spray arm

- 1 Pull out the upper basket.
- 2 Unscrew the spray arm bearings counterclockwise to remove the spray arm from the upper basket.

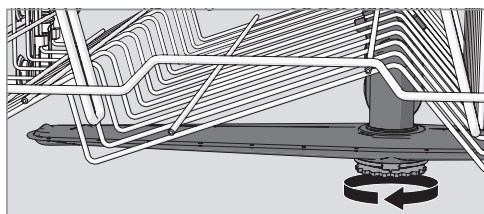

### The door and the door seal

Regularly clean the sides of the door and the door seal. Use a slightly damp cloth (with a little cleaner if necessary).

### The dishwasher tub

The dishwasher tub is made of stainless steel and is kept clean through normal use.

#### Limescale deposits

If you have hard water, limescale deposits may build up in the dishwasher. If this happens, run a self-cleaning program with two tablespoons of citric acid in the detergent compart-

ment (with no dishes in the machine). See Self-cleaning program in the chapter Using the dishwasher.

**TIP!**

Use citric acid or commercially available dishwasher cleaner.

### Display panel

Keep the buttons clean and free from grease. Wipe them clean with a dry or slightly damp cloth. Never use cleaners – they can scratch the surface. Use the main power switch to turn off the dishwasher before cleaning the buttons to avoid activating any buttons unintentionally.

### Unblocking the drain pump

If the dishwasher still contains water after the program has finished, something may be blocking the drain pump. Such items are easily removed.

- 1 Turn off the machine using the main power switch and unplug it from the power outlet.
- 2 Remove the coarse filter and the fine filter.
- 3 Scoop out the water from the dishwasher tub.
- 4 In order to inspect the drain pump, remove the colored stop on the right in the bottom drain.

- 5 Turn the pump wheel located behind the drain pump stop by hand. Carefully remove any items.
- 6 Replace the drain pump stop along with the fine and coarse filters.
- 7 Plug the machine in again.

If the dishwasher still does not start and a whirring sound is heard, the overflow protection has been triggered.

- Shut off the water.
- Unplug the unit from the power outlet.
- Call the Customer Care Center.

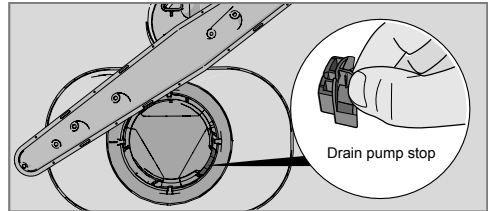

**NOTE!**

Do not forget to replace the drain pump stop.

## Troubleshooting

Type of fault on the display		Action
<b>F10</b>	Overfilling	Clear the drain pump. See the section Care and maintenance instructions. If the problem persists, call the Customer Care Center.
<b>F11</b>	Water outlet fault	See "Water remains in the dishwasher above the filters" in the table "Problem" below. If the problem persists, call the Customer Care Center.
<b>F12</b>	Water inlet fault	Check that the water supply valve is on. If the problem persists, call the Customer Care Center.
<b>F40</b>	Inlet valve leakage	Turn off the water supply valve and call the Customer Care Center.
<b>F52</b>	Water level fault	Call the Customer Care Center.
<b>F54</b>	Overfilling	Turn off the water supply valve and call the Customer Care Center.
<b>F56</b>	Circulation fault	Call the Customer Care Center.

Press any button to clear the error message.

Problem	Possible causes	Action
The buttons do not react when pressed.	You have pressed the buttons too soon after opening the door.	Wait a moment then try again.
	The buttons are dirty.	Clean with a dry or slightly damp cloth.
	The door is closed.	Open the door. The buttons only react to use when the door is open.
Cannot close door.	The baskets are not correctly positioned.	Check that the baskets are correctly positioned horizontally.
		Check that the dishes are not blocking the baskets from sliding properly into place.
	The door lock does not click into place and lock.	Check the door lock. If it does not click into place, open the door. Press and hold the button for the Auto open option for 15 seconds. Then wait 30 seconds. Close the door. Check that the door lock clicks into place.



<b>Problem</b>	<b>Possible causes</b>	<b>Action</b>
The dishwasher does not start.	The door is not closed properly or was not closed immediately after starting the program.	Close the door within four seconds, otherwise the dishwasher will not start. See Starting the dishwasher in the chapter Using the dishwasher.
	The door lock has not clicked into place and locked.	Check the door lock. If it has not clicked into place, open the door. Press and hold the button for the Auto open option for 15 seconds. Then wait 30 seconds. Close the door. Check that the door lock clicks into place.
	A fuse/circuit breaker has been tripped.	Check.
	The plug is not plugged into the power outlet.	Check.
	The water supply valve is turned off.	Check.
	Overflow/leaks.	Check.
	A whirring sound (the drain pump) is heard from the dishwasher and does not stop when the main power switch is turned off.	Turn off the water supply valve. Pull out the plug and call the Customer Care Center.
	Check that the Delayed start option has not been selected.	Press and hold the main power switch until the display turns off if you want to cancel the Delayed start option. Restart the dishwasher.
The dishes are not clean.	The spray arms do not rotate.	Remove the arms and clean them.
		Check that the dishes are not blocking the spray arms.
	Detergent is too old. Detergent is a perishable product.	Avoid large packages.
	Incorrect detergent dosage.	Dose according to water hardness. Far too much or far too little detergent can result in poor dishwashing results.
	Unsuitable dishwashing program.	Choose a longer program.
	Dishes loaded incorrectly.	Do not cover dishes with large bowls or lids. Avoid placing very tall glasses in the corners of the baskets.
	Glasses and cups have toppled over during the program.	Load the dishes securely.
	The filter is not correctly fitted.	Screw the filter firmly into place. See the chapter Care and maintenance instructions.
Spots on stainless steel or silver.	Some types of food, such as mustard, mayonnaise, lemon, vinegar, salt, and dressings, can mark stainless steel if left for too long.	Rinse off these types of food if not starting the dishwasher immediately. Or why not run the Rinse program?
	All stainless steel can cause spots on silver if they come into contact during dishwashing. Aluminum can also cause spots on dishes.	In order to avoid marks and tarnishing, separate dishes made from different metals, such as silver, stainless steel, and aluminum.

<b>Problem</b>	<b>Possible causes</b>	<b>Action</b>
Spots or films on the dishes.	The water softener is leaking salt.	Check that the salt compartment lid is properly tightened. Otherwise call the Customer Care Center.
	Incorrect water softener setting.	See the chapter Settings.
	Incorrect rinse aid dosage setting.	See the chapter Settings.
	Salt compartment empty.	Top up with salt. See the chapter Before washing for the first time.
	3-in-1/all-in-one detergent is used and the setting TAB (3-in-1/all-in-one detergent) is activated.	Inactivate the setting TAB (3-in-1/all-in-one detergent) and top up with salt and rinse aid.
	Too high temperature and/or too much detergent can cause etching on crystal. Unfortunately, this cannot be repaired, only prevented.	Wash crystal at a low temperature and with a conservative amount of detergent. Contact the detergent manufacturer.
The dishes have a sticky white/blue film.	Rinse aid dosage setting too high.	Reduce the amount. See the sections Before washing for the first time and Settings. If you have very soft water, you may want to dilute the rinse aid 50:50 with water.
Spots left after washing.	Lipstick and tea can be difficult to wash off.	Use a detergent with a bleaching agent.
Detergent residue in the detergent compartment after dishwashing.	The detergent compartment was damp when adding detergent.	The detergent compartment must be dry when adding detergent.
Rattling sound when dishwashing.	The dishes are not correctly placed or the spray arms are not rotating.	Check that the dishes are placed securely. Spin the spray arms to make sure they can rotate.
Sound from a fan is heard even when no dishwashing program is running.	The ION setting is activated.	See the chapter Using the dishwasher.
"STR" is shown on the display.	The dishwasher door has been opened while a program is in progress.	If you want the dishwashing program to continue, press any button and close the door within five seconds. If you want to cancel the dishwashing program, press and hold the main power switch until the display turns off.
Water remains in the dishwasher above the filters.	The filters are blocked.	Clean the coarse and fine filters.
	Debris in the drain pump.	Clean the drain pump. See the chapter Care and maintenance instructions.
	Kink in drain hose.	Check that the hose is free from kinks and sharp bends.
	Blocked drain hose.	Loosen the drain hose from where it terminates. Check that no debris has clogged the hose. Is the cone-shaped part of the drain boot cut to the maximum size of the fitting where it attaches?

<b>Problem</b>	<b>Possible causes</b>	<b>Action</b>
Bad odor in dishwasher.	Dirt around the seals and in corners.	Clean with dish brush and low foaming cleaner.
	Low temperature programs have been selected for a prolonged period.	Run a program with a higher temperature about once a month.
	Dirty dishes have been left in the dishwasher for some time.	Activate the ION setting. See the chapter Settings.
Bad odor outside the dishwasher.	The ION setting is activated in a confined space with insufficient ventilation.	Deactivate the ION setting. See the chapter Settings.
The dishes are not dry enough.	The Auto open option is not activated.	Activate the Auto open option.
	The dishwasher is not fully loaded.	Fully load the dishwasher.
	Rinse aid needs topping up or dosage is set too low.	Top up with rinse add or increase the rinse aid dosage. See the sections Before washing for the first time and Settings.
	3-in-1/all-in-one detergent is used and the setting TAB (3-in-1/all-in-one detergent) is activated.	Inactivate the setting TAB (3-in-1/all-in-one detergent) and top up with salt and rinse aid.

# Installation instructions

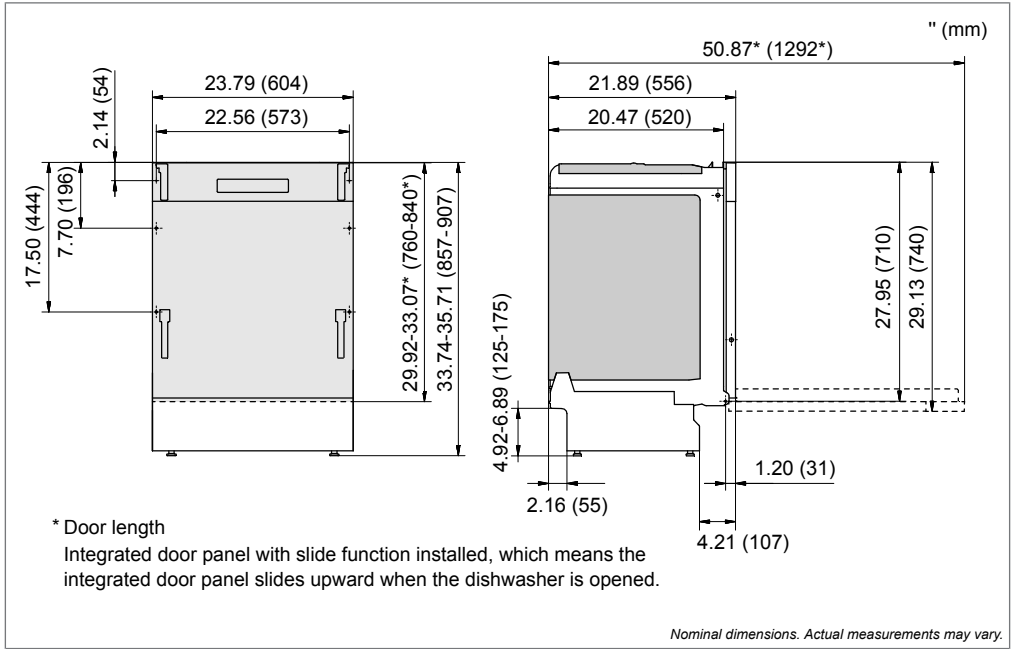

It is important that you read through and follow the instructions and directions below. Conduct installation and connection in accordance with the separate installation instructions.

## Important safety instructions

- Connections to electricity, water, and drainage must be performed by a qualified professional.
- Always follow applicable regulations for water, drainage, and electricity.
- Take care during installation! Wear protective gloves! There must always be two people!
- Place a drip tray on the floor beneath the dishwasher to prevent damage from any water leaks.
- Before screwing the dishwasher into place, test the dishwasher by running the Rinse program. Check that the dishwasher fills with water and drains. Also check that none of the connections leak.

## Setup

- The recess and connection dimensions are included in the separate installation instructions. Check that all dimensions are correct before starting the installation. Note that the height of the integrated door panel can be adjusted to match other fittings.
- The electrical and water supplies should enter through the area indicated by the shading on the illustration.

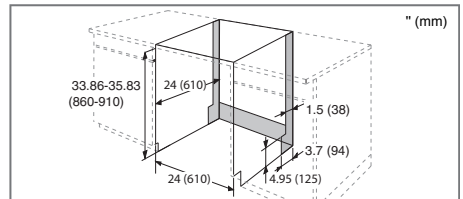

- Make sure the area on which the dishwasher is to be installed is firm. Adjust the adjustable feet so that the dishwasher is level.
- Check that the machine is installed such that the door opens freely, otherwise door lock functionality may be disrupted.

### **⚠ WARNING!**

Turn off the water supply when installing the dishwasher!

### **⚠ WARNING!**

The plug must be disconnected or power to the outlet turned off while installing the dishwasher!

## NOTE!

Framed cabinets require additional finished filler material behind the face frame for a proper installation. A minimum 3½" (89 mm) finished return is required on all sides of the opening.

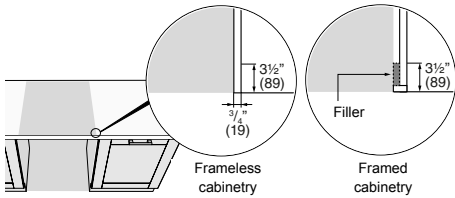

## Drain connection

See the separate installation instructions for necessary information.

This dishwasher is suitable for installing in a raised recess (to attain an ergonomic working height). This means that the dishwasher can be placed so that the drain hose runs to a lower level than the bottom of the dishwasher, such as by routing it directly to a floor drain. The dishwasher is fitted with an integrated anti-siphon device to prevent the machine from being emptied of water during the wash cycle.

The drain hose can also be connected to a connection nipple on the sink unit's water trap. The connection nipple must have an internal diameter of at least 0.6" (14 mm).

The drain hose may be extended by a maximum of 118" (3 m) (the total length of the drain hose must not exceed 177" (4.5 m)). Any joins and connecting pipes must have an internal diameter of at least 0.6" (14 mm). However, the drain hose should ideally be replaced with a new hose without joins.

No part of the drain hose may be more than 37.4" (950 mm) above the bottom of the dishwasher.

Ensure that the drain hose has no kinks.

## Connection to water supply

Use only the inlet hose supplied with the dishwasher. Do not re-use old or other spare hoses.

The supply pipe must be fitted with a water supply valve. The water supply valve must be easily accessible, so that the water can be shut off if the dishwasher has to be moved.

Once the installation is complete, turn on the water supply valve and allow the pressure to settle for a while. Check that all connections are watertight.

## Water supply

The machine can be connected to either a cold<sup>2)</sup> or a hot (max. 160 °F (70 °C)) water supply. The water pressure should be 4.2-140 psi.

## Connection to cold water supply

Connect the dishwasher to the cold water supply if the building is heated using oil, electricity, or gas.

## Connection to hot water supply

Connect the dishwasher to the hot water supply (max. 160 °F (70 °C)) if the building is heated using an energy-efficient means such as district heating, solar power, or geothermal power. Choosing a hot water connection cuts dishwashing times and reduces the dishwasher's energy consumption.

## NOTE!

Do not exceed the permitted water supply temperature. Certain materials used in some cookware cannot withstand strong heat. See Fragile dishes in the chapter Loading the dishwasher.

## Electrical connection

Information about the electrical connection can be found on the serial number plate. This specification must match the electricity supply.

The power supply receptacle for the appliance must be installed in a cabinet or on a wall adjacent to the undercounter space in which the appliance is to be installed. Do not use an extension cord for this appliance.

Use caution when the appliance is installed or removed to reduce the likelihood of damage to the power supply cord.

## Grounding Instructions

This appliance must be grounded. In the event of a malfunction or breakdown, grounding will reduce the risk of electric shock by providing a path of least resistance for electric current. This appliance is equipped with a cord fitted with an equipment grounding conductor and a grounding plug. The plug must be plugged into an appropriate outlet that is installed and grounded in accordance with all local codes and ordinances.

## ⚠ WARNING!

Improper connection of the equipment grounding conductor can result in a risk of electric shock. Check with a qualified electrician or service representative if you are in doubt as to whether the appliance is properly grounded. Do not modify the plug provided with the appliance. If it does not fit the outlet, have an appropriate outlet installed by a qualified electrician.

2) *Recommended.*

# Service

Read the chapter Troubleshooting before contacting the Customer Care Center. If you have encountered a problem that you cannot resolve, please contact your nearest dealer, see [www.gorenje.com](http://www.gorenje.com).

When making contact, provide the details on the serial number plate. Include the article number (1) and the serial number (2).

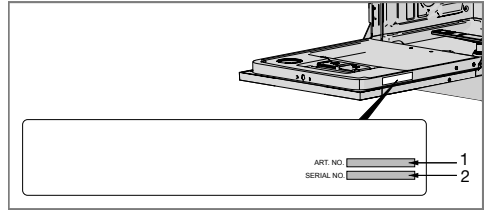



## Technical information

---

### Technical data

Brand: Gorenje  
Model designation: GV67261XXLCUS  
Height: 33.74 - 35.71" (857-907 mm)  
Width: 23.79" (604 mm)  
Depth: 21.89" (556 mm)  
Weight: 82 lb (37 kg) <sup>1)</sup>  
Water pressure: 4.2–140 psi  
Electrical connection: See serial number plate  
Rated power: See serial number plate  
Noise emissions: 42 dB(A) re 1 pW

1) *Weight can vary due to different specifications.*

