

Haier

Installation and User Manual
Manuel d'installation et d'utilisation
Manual de instalación y del usuario

HFC9204ACW
HFC1104ACW
HFC1504ACW

Manual Defrost Chest Freezer

Congélateur bahut à dégivrage manuel

Congelador horizontal de descongelación manual

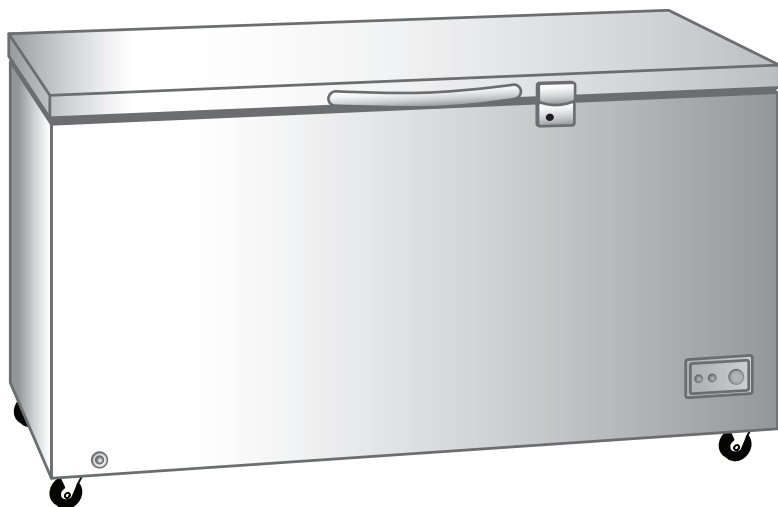

TABLE OF CONTENTS

FREEZER SAFETY	2
PARTS AND FEATURES	5
INSTALLATION REQUIREMENTS	6
Tools and Parts	6
Location Requirements	6
Electrical Requirements	7
FREEZER INSTALLATION	8
Step 1 - Unpack Freezer	8
Step 2 - Install Casters	8
Step 3 - Install Handle.....	10
Step 3 - Complete the Installation	10
FREEZER USE	11
Control	11
Alarm Indicator Light	11
Freezer Lock and Key.....	12
Freezer Baskets	12
FREEZER CARE	13
Cleaning	13
Defrosting and Draining	14
Light	15
Vacation and Moving	15
Reinstalling/Using Freezer Again.....	16
TROUBLESHOOTING	16
LIMITED WARRANTY	18

RECORD KEEPING

Thank you for purchasing this Haier product. This user manual will help you get the best performance from your new freezer.

For future reference, record the model number, serial number, and the date of purchase. The model/serial number plate is located on a label inside the freezer.

Staple your proof of purchase to this manual to aid in obtaining warranty service if needed.

Model number

Serial number

Date of purchase

FREEZER SAFETY

Your safety and the safety of others are very important.

We have provided many important safety messages in this manual and on your appliance. Always read and obey all safety messages.



This is the safety alert symbol.

This symbol alerts you to potential hazards that can kill or hurt you and others. All safety messages will follow the safety alert symbol and either the word "DANGER," "WARNING" or "CAUTION."

These words mean:



An imminently hazardous situation. You could be killed or seriously injured if you don't immediately follow instructions.



A potentially hazardous situation which, if not avoided, could result in death or serious bodily injury.



A potentially hazardous situation which, if not avoided, may result in moderate or minor injury.

All safety messages will tell you what the potential hazard is, tell you how to reduce the chance of injury, and tell you what can happen if the instructions are not followed.

IMPORTANT SAFETY INSTRUCTIONS

WARNING: To reduce the risk of fire, electrical shock, injury to persons, or damage when using the freezer, follow basic precautions, including the following:

- Use this appliance only for its intended purpose as described in this user manual.
- This freezer must be properly installed in accordance with the installation instructions before it is used. See grounding instructions in the installation section.
- Plug into a grounded 3 prong outlet.
- Do not remove ground prong.
- Do not use an adapter.
- Do not use an extension cord.
- Do not repair or replace any part of the appliance unless specifically recommended in the manual. All other servicing should be referred to a qualified technician.
- Disconnect power before servicing.
- Replace all parts and panels before operating.
- Use nonflammable cleaner.
- Keep flammable materials and vapors, such as gasoline, away from freezer.
- Cabinet edges along stamp/cutout areas may be sharp. Avoid placing hands, fingers or other appendages near these areas.
- This freezer should not be recessed or built-in an enclosed cabinet. It is designed for freestanding installation only.
- Before discarding or removing from service, remove the door. This will reduce the possibility of danger to children.

Models HFC9204ACW and HFC1104ACW only:

- Flammable refrigerant used. Do not use mechanical devices to defrost freezer. Do not puncture refrigerant tubing.
- Flammable refrigerant used. To be repaired only by trained service personnel. Do not puncture refrigerant tubing.
- Flammable refrigerant used. Dispose of properly in accordance with federal or local regulations.
- Flammable refrigerant used. Follow handling instructions carefully. Risk of fire or explosion due to puncture of refrigerant tubing.

READ AND SAVE THESE INSTRUCTIONS

State of California Proposition 65 Warnings:

WARNING: This product contains one or more chemicals known to the State of California to cause cancer.

WARNING: This product contains one or more chemicals known to the State of California to cause birth defects or other reproductive harm.

PROPER DISPOSAL OF YOUR OLD REFRIGERATED APPLIANCE

WARNING

Suffocation Hazard

Remove doors or lid from your old freezer or refrigerator.

Failure to do so can result in death or brain damage.

IMPORTANT: Child entrapment and suffocation are not problems of the past. A junked or abandoned freezers or refrigerators are still dangerous – even if it will sit for “just a few days.” If you are getting rid of your old refrigerator or freezer, please follow these instructions to help prevent accidents.

Before You Throw Away Your Old Freezer or Refrigerator:

- Remove the doors or lid.
- Leave any shelves in place so that children may not easily climb inside.

Important information to know about disposal of refrigerants:

Dispose of freezer in accordance with Federal and Local regulations. Refrigerants must be evacuated by a licensed, EPA certified refrigerant technician in accordance with established procedures.

PARTS AND FEATURES

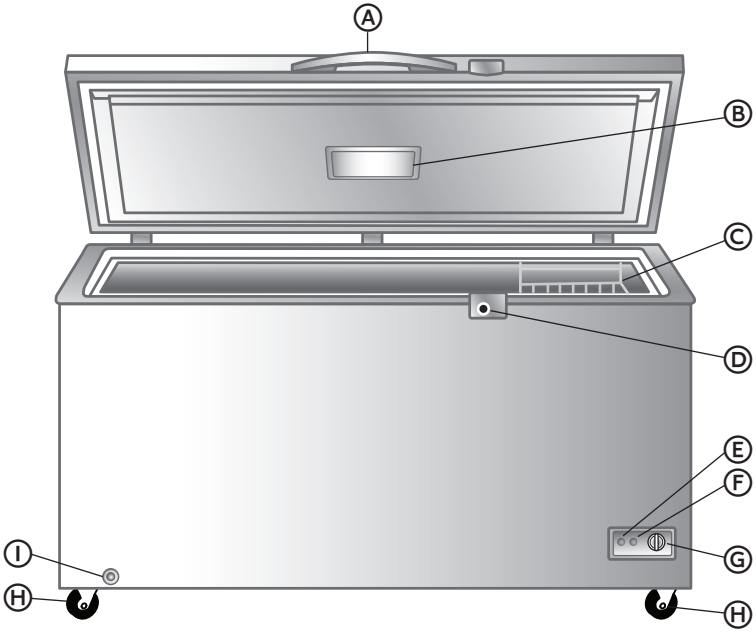

(A) Handle

(B) Light

(C) Removable Wire Basket (2)

(D) Security Lock (with key)

(E) Power Indicator (green light)

(F) Alarm Indicator (red light)

(G) Temperature Control

(H) Casters

Models HFC9204 and HFC1104
(4) - 2 Locking

Model HFC1540 (6) - 3 Locking

(I) Exterior Drain Plug

INSTALLATION REQUIREMENTS

TOOLS AND PARTS

TOOLS NEEDED

- Carpenter's Level

PARTS PROVIDED

- Handle Screws (4)
- Caster Screws (4 or 6 depending on model)
- Screwdriver
- Handle
- Casters (4 or 6 depending on model)
- Key

LOCATION REQUIREMENTS

WARNING



Explosion and Fire Hazard

Keep flammable materials and vapors, such as gasoline, away from appliance.

Failure to do so can result in death, explosion or fire.

IMPORTANT:

- This freezer is designed for freestanding installation only. It should not be recessed or built-in an enclosed cabinet. To ensure your freezer works at optimum efficiency, you should install it in a location where there is proper air circulation, and electrical connections.
- Do not install your freezer in any location not properly insulated or heated such as a garage.

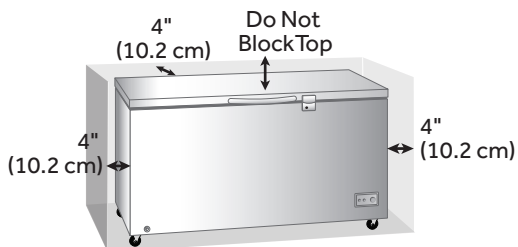
Recommended Clearances:

- Your freezer is designed for use in a location where the temperature ranges from a minimum of 55°F (13°C) to a maximum of 110°F (43°C).
- It is recommended that you do not install the freezer in direct sunlight or near a heat source e.g. radiators, baseboard heaters, cooking appliances etc.
- Place the freezer on a hard, even floor that is strong enough to support it fully loaded. Any floor unevenness should be corrected before placing the freezer.

ELECTRICAL REQUIREMENTS**! WARNING****Electrical Shock Hazard**

Plug into a grounded 3 prong outlet.

Do not remove the ground prong from the power cord plug.

Do not use an adapter.

Do not use an extension cord.

Failure to do so can result in death, fire or electrical shock.

Before you move your freezer to a location, it is important to make sure you have the proper electrical connection.

Recommended Grounding Method

A 115 Volt, 60 Hz., AC only, 15-amp fused, grounded electrical supply is required. It is recommended that a separate circuit serving only your freezer be provided. Use an outlet that cannot be turned off by a switch. Do not use an extension cord.

FREEZER INSTALLATION

STEP 1 - UNPACK FREEZER

The following warning is for models HFC9204ACW and HFC1104ACW only:

WARNING



Fire or Explosion Hazard

Do not puncture refrigerant tubing.

Follow handling instructions carefully.

Flammable refrigerant used.

Failure to do so can result in death, explosion or fire.

IMPORTANT: Handle with care when moving freezer to avoid either damaging the refrigerant tubing or increasing the risk of a leak.

1. Remove and dispose of/recycle all packing materials. This includes the foam base and all adhesive tape. Remove all protective packaging covering the freezer.
2. Remove user manual and other printed material before turning on the freezer.
3. Clean the exterior surface with a soft cloth.

STEP 2 - INSTALL CASTERS

WARNING

Excessive Weight Hazard

Use two or more people to move and install freezer.

Failure to do so can result in back or other injury.

Depending on your model, the freezer comes with either 4 or 6 casters (packaged with a screwdriver and screws [1 per caster] inside the freezer).

1. Open the freezer lid, remove the baskets, casters, screwdriver and other accessories.
2. Using two or more people, gently lay the freezer onto its back.

NOTE: The casters with locks should be installed on the front corners of the freezer.

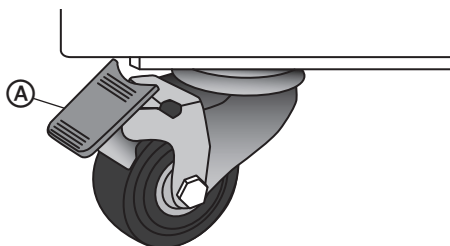

Ⓐ Castor Lock

3. Orient each castor so that the hole in the castor mounting plate will align with the hole located in each corner of the cabinet bottom.

NOTES:

- Make sure the castors with locks are installed on the front of the freezer.
- Freezer models with 6 castors - Install a castor to each of the four corners, and also install a castor in the center front and center back of the freezer.

4. Slide each castor into the castor brackets until the holes align.

NOTES:

- Each castor will slide into the corner brackets from a different direction.
- It may be necessary to lift the bottom of the freezer slightly to insert the rear castors into their brackets.

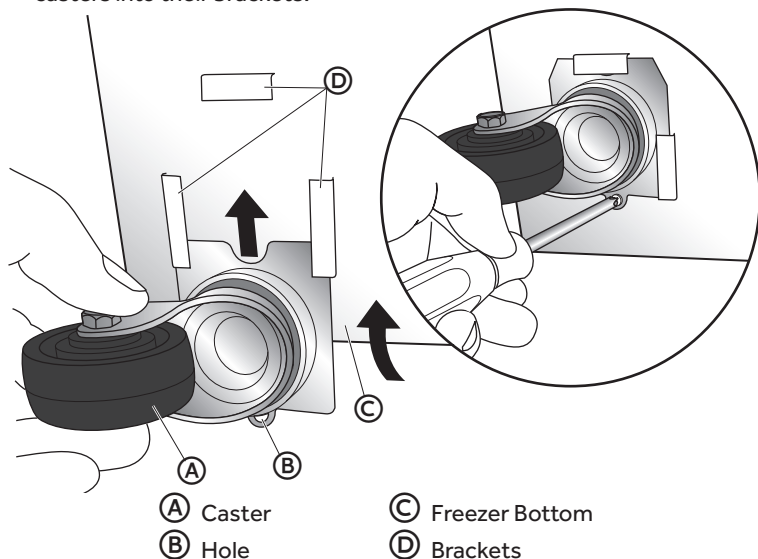

Ⓐ Castor

Ⓑ Hole

Ⓒ Freezer Bottom

Ⓓ Brackets

5. Using one screw per castor, fasten the castor to the freezer bottom. Repeat for the remaining castors.
6. Using the screwdriver (provided), completely tighten the screws.
7. Using two or more people, gently lift the freezer to an upright position.
8. Move the freezer to its final location, and then lock the castors (step on each front castor lock) to keep the freezer from rolling.

STEP 3 - INSTALL HANDLE

1. Position the handle on the front of the lid so that the flat side is up and the notched side is down.
2. Using the four handle screws (provided), fasten the handle to the front edge of the freezer lid.

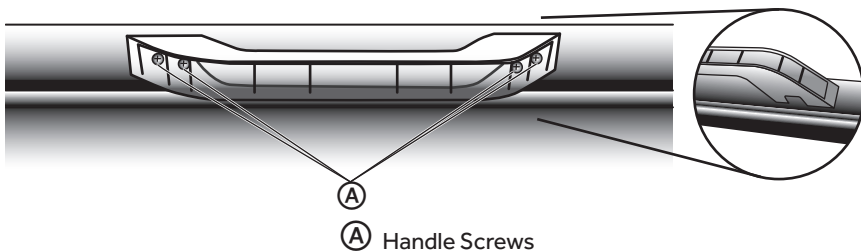

3. Insert one end of the handle cover into the handle holder.

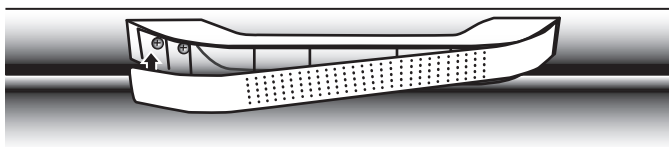

4. Insert the other end of handle cover into the handle holder, and then press the cover into the handle holder.

STEP 3 - COMPLETE THE INSTALLATION

IMPORTANT: If the freezer has been in a horizontal position for any period of time, wait 24 hours before plugging in the freezer to allow the refrigerant to settle.

⚠ WARNING



Electrical Shock Hazard

Plug into a grounded 3 prong outlet.

Do not remove the ground prong from the power cord plug.

Do not use an adapter.

Do not use an extension cord.

Failure to do so can result in death, fire or electrical shock.

1. Plug into a grounded 3 prong outlet.
2. Using a carpenter's level, make sure the freezer is level from front to back, and from side to side. Shim if necessary.

FREEZER USE

CONTROL

The control, located on the front of the freezer cabinet, is an adjustable dial with Temperature settings ranging from 1 (Least Cold) to 7 (Coldest), and Off.

The Power On Light (green) indicates that the freezer is properly connected to electrical power. The light glows even when the temperature is turned to OFF.

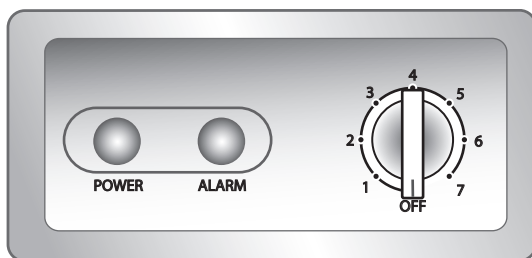

1. Turn the temperature control dial to 4 (Recommended Setting).
2. Allow the freezer to cool for several hours before adding food.

ADJUSTING THE TEMPERATURE

The recommended setting (4) is designed to maintain the temperature at or near 0°F (-17.8°C) under normal operating conditions.

To Adjust the Freezer Temperature:

1. Adjust the control dial to one of the adjacent settings 3 (less cold) or 5 (colder).

NOTE: Except when starting the freezer, do not adjust the control more than one setting at a time.

2. Wait 24 hours between adjustments for the freezer temperature to stabilize.

ALARM INDICATOR LIGHT

Your chest freezer is equipped with a RED indicator light. There is no audible alarm.

- The Alarm indicator light will illuminate (red) when the freezer is first plugged in, and will remain lit until the freezer interior temperature reaches approximately 7°F (-13.9°C) below the set temperature.
- Once the freezer interior temperature is lower than the set temperature, the Alarm indicator light will turn off.

FREEZER LOCK AND KEY

IMPORTANT:

- Store the freezer key in a location away from the freezer and not easily accessible to children.
- The freezer lock is spring loaded. The freezer key must be manually held in the lock to either lock or unlock the freezer.

To Lock/Unlock the Freezer:

Close the freezer lid, insert the key, push in and turn the key to lock. To unlock, insert the key, push in and turn the key in the opposite direction.

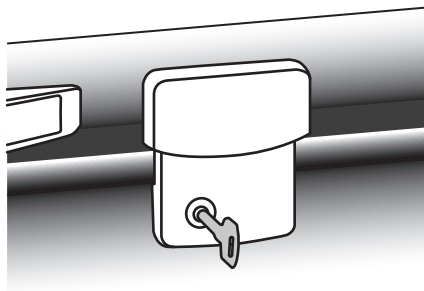

FREEZER BASKETS

For storage flexibility, your freezer comes with two removable wire baskets. The removable freezer baskets allow easier access to foods used frequently.

CLEANING

WARNING



Explosion Hazard

Use nonflammable cleaner.

Failure to do so can result in death, explosion or fire.

IMPORTANT: Do not use harsh chemicals, ammonia, chlorine bleach, concentrated detergent, solvents, abrasives or metal scouring pads to clean your freezer inside or out. They can damage and/or discolor the freezer finish.

WARNING



Electrical Shock Hazard

Unplug your appliance or disconnect power before cleaning.

Failure to do so can result in death, electric shock or personal injury.

1. Unplug freezer or disconnect power.
2. Before using cleaning products, always read and follow manufacturer's instructions and warnings to avoid personal injury or product damage.
3. Wash interior surfaces, accessories, and outer frame with cold water and a little baking soda.
4. Dry thoroughly with a soft cloth.
5. Plug in or reconnect power.

DOOR GASKETS

Gaskets must be kept clean and pliable to assure a proper seal.

- Clean door gaskets every 3 months with solution of baking soda and warm water.
- Petroleum jelly applied lightly on the hinge side of gaskets will keep the gasket pliable and assure a good seal.

DEFROSTING AND DRAINING

The following warning is for models HFC9204ACW and HFC1104ACW only:

DANGER



Fire or Explosion Hazard

Flammable refrigerant used.

Do not use mechanical devices to defrost freezer.

Do not puncture refrigerant tubing.

Failure to do so can result in death, explosion or fire.

For most efficient operation and minimum energy consumption, defrost whenever the frost becomes $\frac{1}{4}$ " (6 mm) thick.

IMPORTANT:

- Do not use mechanical devices to defrost freezer.
 - Do not use boiling water as it may damage the freezer.
1. Turn the temperature control to OFF and unplug the freezer.

NOTE: Defrosting usually takes a few hours. To defrost faster keep the freezer door open.
 2. Place a tray (not included) in front of the freezer, beneath the outer drain plug, to collect the water. Unscrew and remove both the interior and exterior drain plugs to allow the water to flow out into the tray.

NOTE: Water that has accumulated at the bottom of the freezer during defrosting will drain into the pan. Monitor the container under the drain to avoid overflow.
 3. When defrosting is complete, wipe the interior of the freezer with a soft cloth, and replace the drain plugs.

⚠ WARNING



Electrical Shock Hazard

Plug into a grounded 3 prong outlet.

Do not remove the ground prong from the power cord plug.

Do not use an adapter.

Do not use an extension cord.

Failure to do so can result in death, fire or electrical shock.

4. Plug into a grounded 3 prong outlet.
5. Reset the temperature control to your preferred setting.
6. Return the food into the freezer.

LIGHT

IMPORTANT: Your freezer is equipped with LED lighting.

The LED light is designed to last for the life of your freezer. However, if the light stops operating, please contact a qualified technician for replacement.

VACATION AND MOVING

IMPORTANT: When moving freezer, handle with care to avoid either damaging the refrigerant tubing or increasing the risk of a leak.

For long vacations or absences:

- Remove food from freezer.
- Turn the temperature control to OFF.
- Unplug or disconnect power.
- Clean the door gaskets. See "Cleaning."
- Prop open the doors to allow air to circulate inside.

REINSTALLING/USING FREEZER AGAIN

If the freezer has been placed in a horizontal or tilted position for any period of time wait 24 hours before plugging in the freezer to allow the refrigerant to settle.

1. Clean Freezer. See "Cleaning."
2. Move freezer to desired location. Check that it is level and shim, if necessary.

WARNING



Electrical Shock Hazard

Plug into a grounded 3 prong outlet.

Do not remove the ground prong from the power cord plug.

Do not use an adapter.

Do not use an extension cord.

Failure to do so can result in death, fire or electrical shock.

3. Plug into grounded 3 prong outlet.
4. Set the Temperature control to the recommended setting, and allow time for the freezer to cool completely before adding food.

TROUBLESHOOTING

First try the solutions suggested here to possibly avoid the cost of a service call.

PROBLEM	POSSIBLE CAUSE(S)	SOLUTION
Freezer does not run	The freezer is unplugged.	Plug freezer into a grounded 3 prong outlet.
	The circuit breaker is tripped or turned off / Fuse is blown.	Reset / Turn on circuit breaker or replace fuse
	The temperature control is turned to OFF.	Turn the temperature control to a setting between 1 and 7.
	The compressor has cycled off.	Wait 30 to 40 minutes to see whether the compressor will start.

PROBLEM	POSSIBLE CAUSE(S)	SOLUTION
Compressor runs too frequently	The room is hot and/or humid.	This may be normal to maintain constant freezer temperature during high temperature and humid days.
	The freezer door is ajar.	Completely close the freezer door.
	The door gasket is not sealing properly.	Clean the door gasket. See "Cleaning."
	Frequent or prolonged door openings.	Limit door openings to maintain the internal temperature of the freezer.
	The freezer door is blocked open.	Rearrange or remove items from blocking open the freezer door.
Food temperature is too warm	The door is opened frequently.	Limit door openings.
	A large load of food was recently added.	Allow time for recently added warm food to cool to freezer temperature.
	The freezer door is not sealing properly.	Clean door gasket. See "Cleaning."
	The control is not set to a cold enough temperature.	Adjust the temperature control to a colder setting.
Food temperature is too cold.	The control is set to a too cold setting.	Adjust the temperature control to a less cold setting.
Freezer has an odor	The freezer needs cleaning.	Clean the freezer. See "Cleaning."
	Food is improperly wrapped or sealed and is giving off odor.	Wrap and seal food tightly before storing in the freezer.
Light does not come on	Freezer is unplugged.	Plug freezer in to power source.
	LED light is burned out.	Contact a qualified technician to replace the burned out LED.
Gurgling sound	Refrigerant circulating through the cooling coils.	This sound is normal.
Clicking	The temperature control cycling on and off.	This sound is normal.

FOR MORE HELP, VISIT [HAIER.COM](http://haier.com) OR CALL THE CONSUMER HELP LINE AT 1-877-337-3639.

LIMITED WARRANTY

IN-HOME SERVICE

FULL ONE YEAR WARRANTY

For 12 months from the date of original retail purchase, Haier will repair or replace any part free of charge including labor that fails due to a defect in materials or workmanship.

Haier may replace or repair at their sole discretion any part, sub system including the entire product.

Product must be accessible, without encumbrance and installed properly to receive warranty repair service.

LIMITED WARRANTY

NOTE: This warranty commences on the date the item was purchased, and the original purchase receipt must be presented to the authorized service representative before warranty repairs are rendered.

Exceptions: Commercial Use Warranty
90 days labor from date of original purchase
90 days parts from date of original purchase

No other warranty applies.

FOR WARRANTY SERVICE

All service must be performed by a Haier authorized service center. For the name and telephone number of the nearest authorized service center, please call 1-877-337-3639.

Before calling please have available the following information:

Model number and serial number of your appliance. The name and address of the dealer you purchased the unit from and the date of purchase.

A clear description of the problem.

A proof of purchase (sales receipt).

This warranty covers home appliance services within the contiguous United States and Canada and where available in Alaska, Hawaii and Puerto Rico.

What is not covered by this warranty:

Replacement or repair of household fuses, circuit breakers, wiring or plumbing.

A product whose original serial number has been removed or altered.

Any service charges not specifically identified as normal such as normal service area or hours.

Damage incurred in shipping.

Damage caused by improper installation or maintenance.

Damage from misuse, abuse, accident, fire, flood, or acts of nature.

Damage from service other than an authorized Haier dealer or service center.

Damage from incorrect electrical current, voltage or supply.

Damage resulting from any product modification, alteration or adjustment not authorized by Haier.

Adjustment of consumer operated controls as identified in the owner's manual.

Hoses, knobs, lint trays and all attachments, accessories and disposable parts.

Labor, service transportation, and shipping charges for the removal and replacement of defective parts beyond the initial 12-month period.

Damage from other than normal household use.

Any transportation and shipping charges.

THIS LIMITED WARRANTY IS GIVEN IN LIEU OF ALL OTHER WARRANTIES, EXPRESSED OR IMPLIED, INCLUDING BUT NOT LIMITED TO, THE WARRANTIES OF MERCHANTABILITY AND FITNESS FOR A PARTICULAR PURPOSE.

The remedy provided in this warranty is exclusive and is granted in lieu of all other remedies.

This warranty does not cover incidental or consequential damages, so the above limitations may not apply to you. Some states do not allow limitations on how long an implied warranty lasts, so the above limitations may not apply to you.

This warranty gives you specific legal rights, and you may have other rights, which vary from state to state.

Haier America
Wayne, NJ 07470