

Hisense

life reimagined

USER'S OPERATION MANUAL

Before operating this unit, please read this manual thoroughly, and retain for future reference

RB15N6ASE
RB15N6ABE

English

Contents

Brief introduction.....	3	Using your appliance.....	14
Important safety instructions.....	4	Cleaning and care.....	15
Installing your new appliance.....	6	Helpful hints and tips.....	17
Description of the appliance.....	11	Troubleshooting.....	19
Display controls.....	12	Disposal of the appliance.....	20

Brief Introduction

Thank you for choosing Hisense. We are sure you will find your new refrigerator a pleasure to use. Before you use the appliance, we recommend that you read through these instructions carefully, which provides details about its usage and functions.

- Please ensure that everyone using this appliance is familiar with its operations and safety features. It is important that you install the appliance correctly and pay careful attention to the safety instructions.

- We recommend that you keep this user's manual with the appliance for future reference.

- This appliance is intended to be used in households and similar applications such as:

- Staff kitchen-areas in shops, offices and other working environments;
- Clients in hotels, motels and other residential types of environment;
- Bed and breakfast type of environments;
- Catering and similar non-retail applications.

- This appliance is not intended for use by persons (including children) with reduced physical, sensory or mental capabilities, or lack of experience and knowledge, unless they have supervision or been given instruction concerning use of the appliance. Children should be supervised

to ensure that they do not play with the appliance.

- Do not store explosive substances such as aerosol cans with a flammable propellant in this appliance.

WARNING — Connect to potable water supply only.

WARNING — Do not use mechanical devices or other means to accelerate the defrosting process, other than those recommended by the manufacturer.

WARNING — Do not damage the refrigerant circuit.

WARNING — Do not use electrical appliances inside the food storage compartments of the appliance, unless they are of the type recommended by the manufacturer.

WARNING — When disposing of the appliance do so only at an authorized waste disposal centre. Do not expose to flame.

WARNING — The instructions include the following wording regarding the use of extension cords or ungrounded (two prong) adapters: Do not use an extension cord or ungrounded (two prong) adapters.

WARNING — If the supply cord is damaged, it must be replaced by the manufacturer, its service agent or similarly qualified persons in order to avoid a hazard.

Important Safety Instructions

General safety and daily use



It is important to use your appliances safely. We recommend that you follow the guidelines below.

Store any food in accordance with the storage instructions from the manufacturer.

- Don't try to repair the appliance yourself. It is dangerous to alter the specifications or modify this product in any way. Any damage to the power cord may cause a short circuit, fire or electric shock.
- Don't place too much food directly against the air outlet on the rear wall of both the refrigerator and freezer compartment, as it affects sufficient air circulation.
- Don't place hot items near the plastic components of this appliance.
- Frozen food must not be refrozen once it has been thawed out.
- Don't store bottled or canned drinks (especially carbonated drinks) in the freezer compartment. Bottles and cans may explode.
- Use caution consuming popsicles or ice cubes straight from the freezer as this can cause freezer burn to the mouth and lips.

Safety for children and infirm persons

- Keep all packaging away from children to avoid risk of suffocation.
- Protect children from being scalded by touching the compressor at the rear bottom of appliance
- Don't place items on top of the appliance as this could cause injury should they fall off.
- Never allow children to play with the appliance by hanging or standing over or on the doors, racks, shelves and drawers

etc.

Electrical Safety



To avoid the risks that are always present when using an electric appliance, we recommend that you pay attention to the instructions about electricity below.

- Unpack and check through the appliance. Should any damage be evident, don't plug in the appliance but contact the shop immediately from which you purchased it. Keep all packing materials in this case.
 - We recommend that you wait for 4 hours before connecting the appliance to allow the refrigerant to flow back into the compressor.
 - The appliance must be applied with single phase alternating current of **115V/60Hz**. If the voltage fluctuates exceeding the upper limit, A.C. automatic voltage regulator of more than 350W should be applied to the refrigerator for safety use.
 - The power plug must be accessible when the appliance is installed.
 - This appliance must be grounded.
 - This appliance is fitted with a plug, in accordance with local standard. The plug should be suitable for use in all houses fitted with sockets in accordance with current specifications.
 - If the fitted plug is not suitable for your socket outlets, it should be cut off and carefully disposed of. To avoid a possible shock hazard, do not insert the discarded plug into a socket. If in doubt contact a qualified, registered electrician.
 - Do not use extension cords, ungrounded (two prong) adapters or multiple sockets which could cause overloading of wiring circuits and could cause a fire.
- Always plug your appliance into its own

individual electrical socket which has a voltage rating that matched the rating plate.

- Make sure that the plug is not squashed or damaged. Otherwise, it may cause short circuit, electric shock or overheat and even cause a fire.
- Do not insert the power plug if the socket is loose, there is a risk of electric shock or fire.
- Switch off the appliance and disconnect it from the main power before you clean or move it.
- Never unplug the appliance by pulling on the electrical cord. Always grip the plug firmly and pull straight out from the socket to prevent damaging the power cord.
- Do not operate the appliance without the cover of interior lighting.
- Any electrical component must be replaced or repaired by a qualified electrician or authorized service engineer. Only genuine replacement parts should be used.
- Do not use electrical appliances such as ice cream makers inside the food storage compartments of the appliance unless they are approved by the

manufacturer.

- To avoid eye injury, do not look directly into the LED light located in the refrigerator compartment. If it is not functioning correctly, consult a qualified, registered electrician or replace it in accordance with the “cleaning and care” chapter.

Refrigerant

The refrigerant isobutene (R600a) is contained within the refrigerant circuit of the appliance. During transportation and installation of the appliance, ensure that none of the components of the refrigerant circuit becomes damaged. The refrigerant (R600a) is flammable.



Caution: Risk of Fire

- Don't store products which contain flammable propellants (e.g. spray cans) or explosive substances in the appliances.

Should the refrigerant circuit be damaged:

- Avoid open flames (candles, lamps etc.) and sources of ignition.
- Thoroughly ventilate the room in which the appliance is situated.

Installing your new appliance

Before using the appliance for the first time, you should be informed of the following tips.

Warning!

For proper installation, this refrigerator must be placed on a level surface of hard material that is the same height as the rest of the flooring. This surface should be strong enough to support a fully loaded refrigerator.

The rollers, which are not castors, should be only used for forward or backward movement. Moving the refrigerator sideways may damage your floor and the rollers.

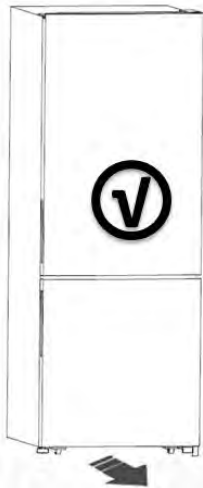

Ventilation of appliance



In order to improve efficiency of the cooling system and save energy, it is necessary to maintain good ventilation around the appliance for the dissipation of heat. For this reason, sufficient clear space should be available around the refrigerator.

Suggestion: It is advisable for there to be 50-70mm of space from the back to the wall, at least 100mm from its top, at least 100mm from its side to the wall and a clear space in front to allow the doors to open 130°. As shown in follow diagrams.

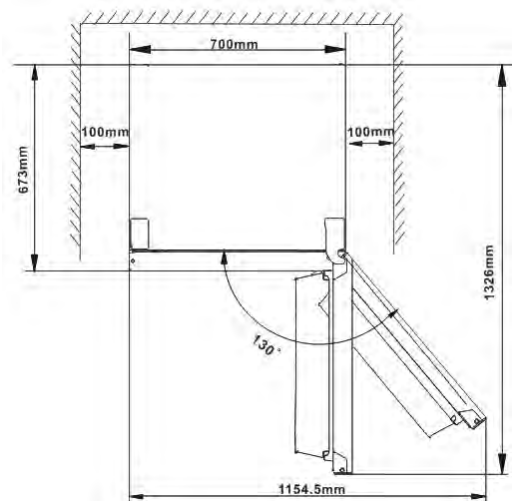
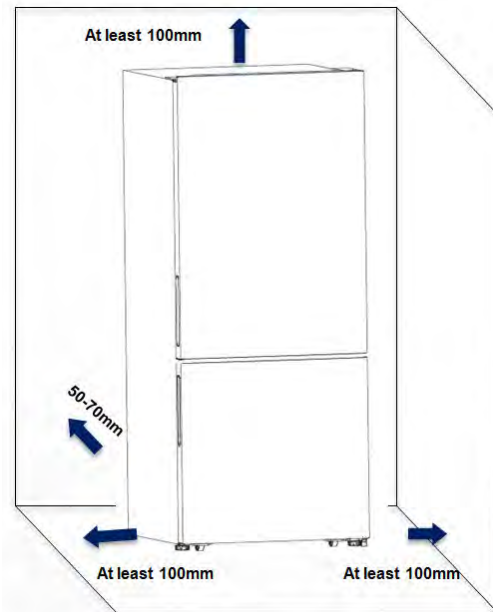

Note:

- This appliance performs well within the ambient temperature from 12.8 °C to 43.3 °C. It may not work properly if left at a temperature above or below the indicated range for a long period.
- Stand your appliance in a dry place to avoid high moisture.
- Keep the appliance out of direct sunlight, rain or frost. Stand the appliance away from heat sources such as stoves, fires or heaters.

Leveling of appliance

- For sufficient leveling and air circulating in the lower rear section of the appliance, the bottom feet may need to be adjusted. You can adjust them manually by hand or by using a suitable spanner.
- To allow the doors to self-close, tilt the top backwards by 10-15mm.

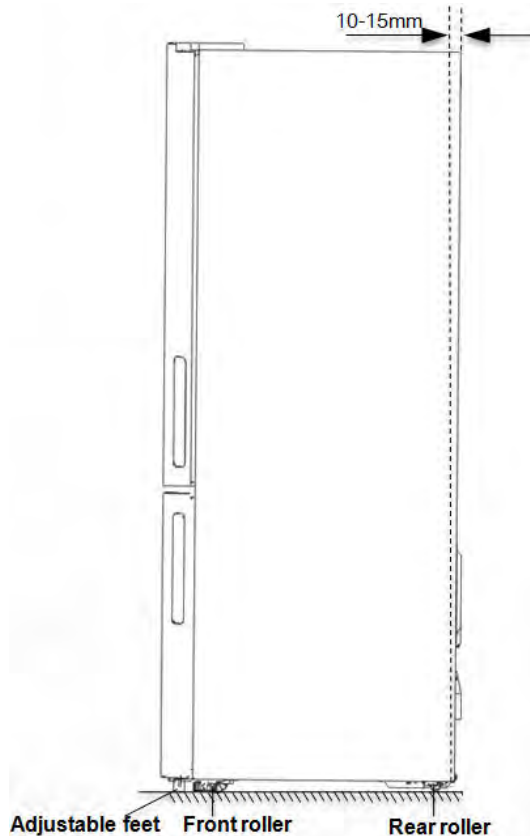







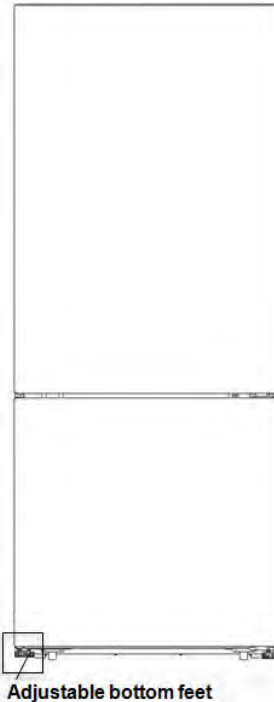

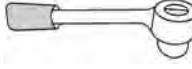
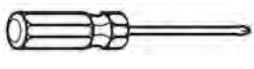
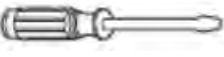
Reversing the door

The side at which the door opens can be changed, from the right side (as supplied) to the left side if required.

Warning! When reversing the door, the appliance must not be connected to the main socket, Ensure that the plug is removed from the main socket



Not provided	
	
Wrench(8mm)	Philips Screwdriver
	
Thin-blade screwdriver	Monkey wrench
Additional parts (in the plastic bag)	
	
Allen Wrench(4mm)	
	
Left Hinge	Left Hinge Cover
	
Right Screw Cover	Left Middle Hinge
	
Left Door Stopper*2	Left Door Catcher*2

Note: If required you may lay the refrigerator on its back in order to gain access to the base, you should rest it on soft foam packaging or similar material to avoid damaging the backboard of the refrigerator. To reverse the door, the following steps are generally recommended.

1. Stand the refrigerator upright. Open the door to take out all door racks (to avoid damage) and then close the door.

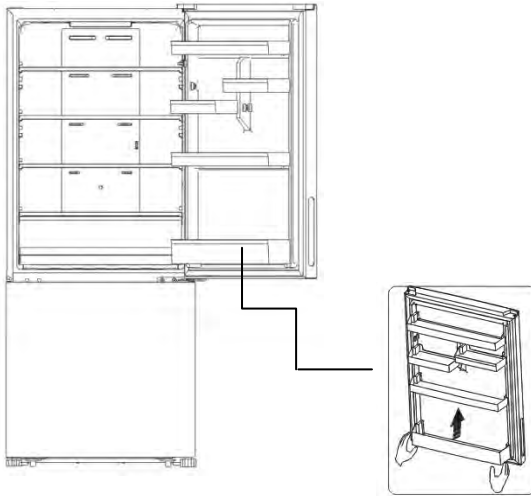

Caution!

Please slightly squeeze the door rack from two sides toward center and inside of door rack, and then move it upward when taking out the upper rack and lower rack.

2. Remove right upper hinge cover ① top of the cabinet. Remove the 3 screws ② which are used for fixing the right upper hinge part (see the picture below) and take down the upper hinge parts ③

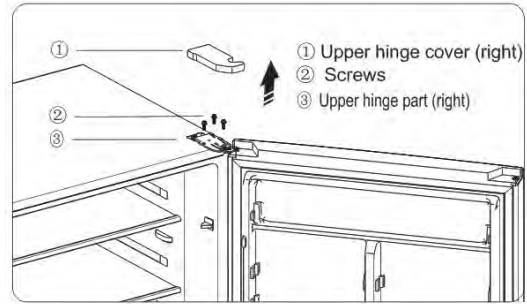
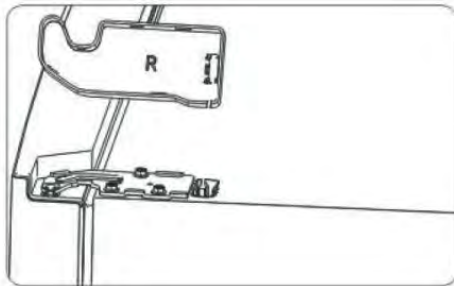

3. Remove screw cover from the left-front corner of cabinet with thin-blade screwdriver and install screw cover-right to the right front corner. Put the upper hinge cover(right) and upper hinge part (right) into the plastic bag.

4. Remove the upper door from the middle hinge by carefully lifting the door straight up.

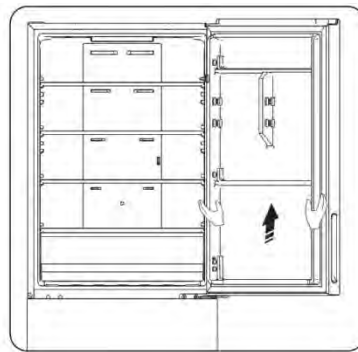

5. Place the upper door on a smooth surface with its panel upwards. Loosen screws ② and take down part ③ and part ①, install left door Catcher and left DoorStopper to the left door with included screws ③. Keep part ① and ② with the appliance for future reference.

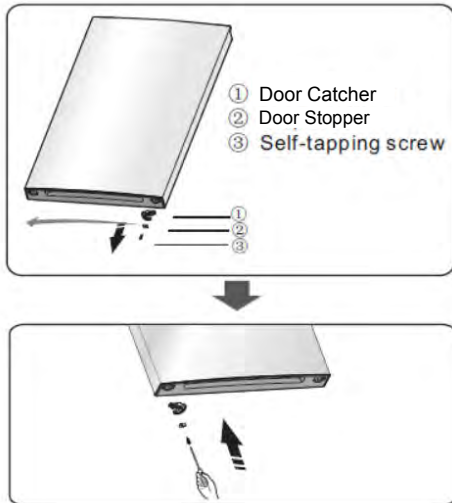

6. Use the Allen wrench (provided in the plastic bag) to loosen screws used to fix the right middle hinge and remove right middle hinge. Then remove the lower door.

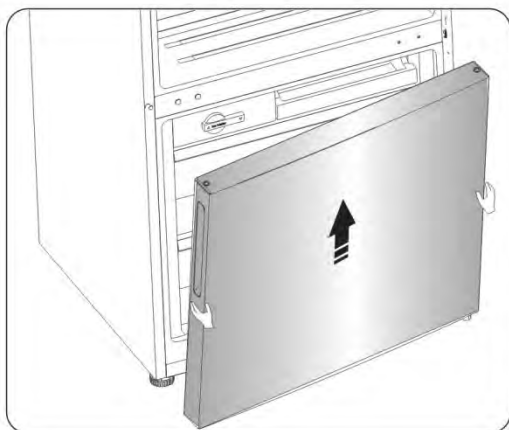
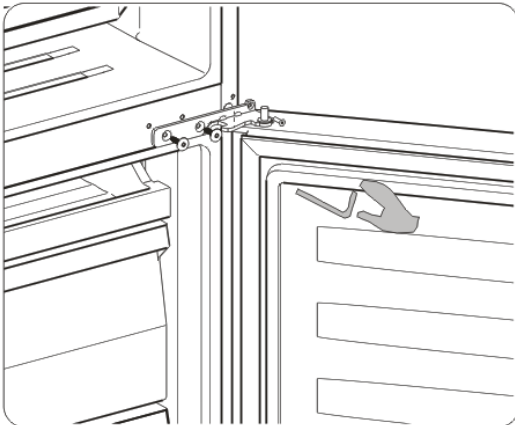

7. Place the lower door on a smooth surface with its panel upwards. Loosen screw ③ and take down part ② and part ①, Install replacement door

stopper-left provided (in the plastic bag) and Left Door Stopper to the left side with screw ③. Keep part ① and ② with the appliance for future reference.

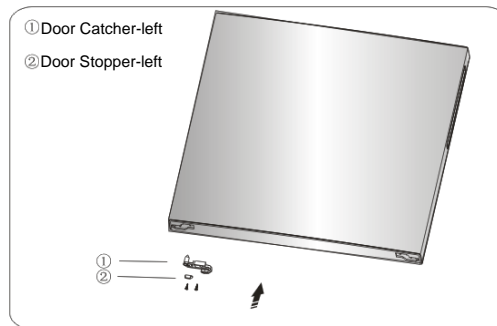
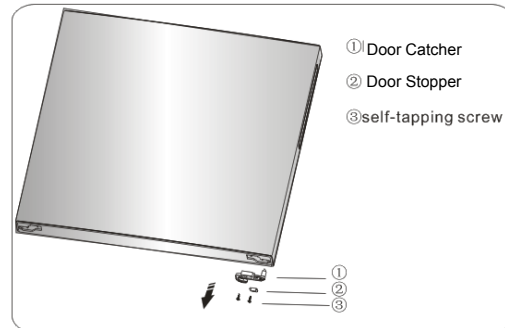

8. Change screw hole covers and screw on middle cover plate from left to right (as shown in figure below).



9. Lie the refrigerator backwards, Remove ④ (right), Remove three self-tapping screws from the lower hinge part (right). Loosen the lower hinge axis then install it on the reverse holesite, and tighten into position (change it into left hinge part). Remove the lower hinge part to the left-bottom corner of the cabinet, Then fix it with 3 screws, finally install part ④ on the left-bottom and right-bottom of cabinet.

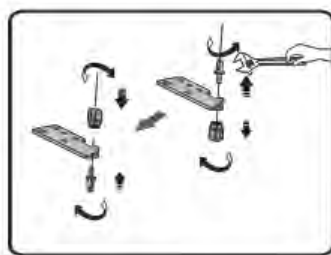
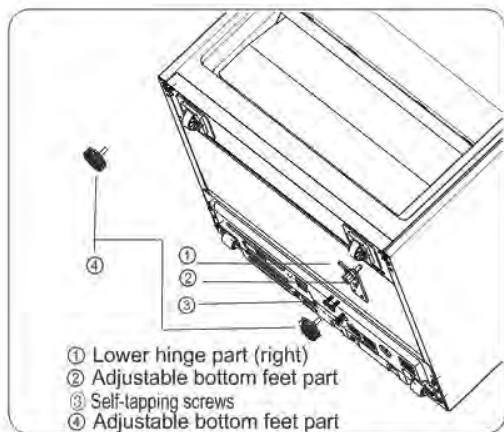

10. Stand the refrigerator upright and carefully slot the lower door onto the lower hinge pin and hold in position. install middle hinge-left (in the plastic bag) ensuring the lower door in secured in place.

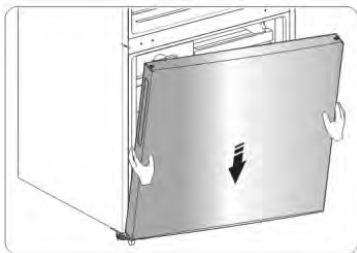

11. Carefully slot the upper door onto the middle hinge pin and hold in position. Move the upper door to an appropriate position, adjust left upper hinge (in the

plastic bag) and upper door, then fit the hinge pin into the hinge hole at the top and the door to secure the door in place. Then fix the upper hinge part with screws (Please carefully hold upper door by hand when installing)



12. Install the temperature sensor part on the left hinge cover. Assemble the left hinge cover provided (in the plastic bag) to match the hinge, install the door racks to original position. Keep the right hinge cover with the appliance for future reference.

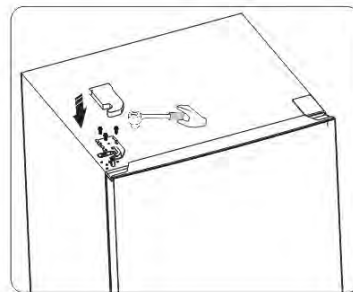

Description of the appliance

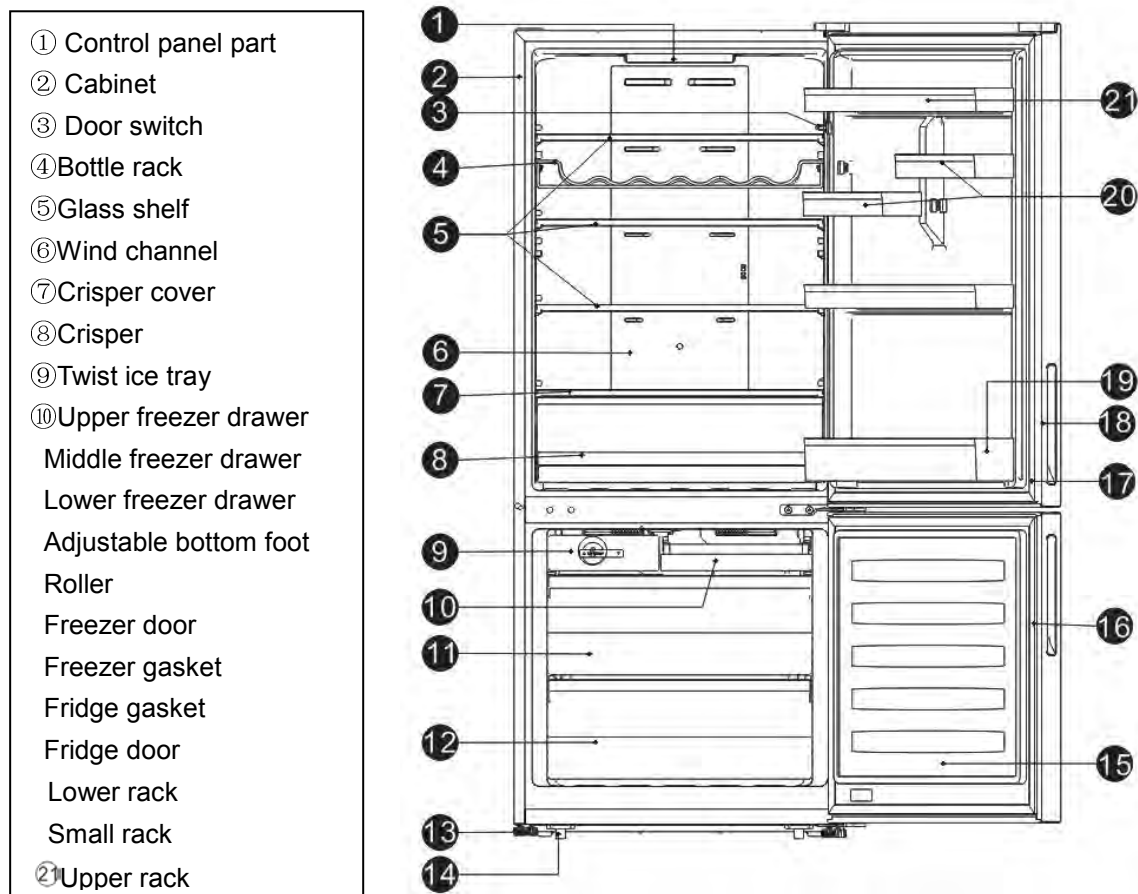

Note!

- Due to unceasing modification of our products, your refrigerator may be slightly different from this instruction manual, but its functions and using methods remain the same.
- To get the best energy efficiency of this product, please place all shelves, drawers and baskets on their original position as the illustration above.

Display Controls

Use your appliance according to the following guidelines, your appliance has functions on the control panel shown in the pictures below.

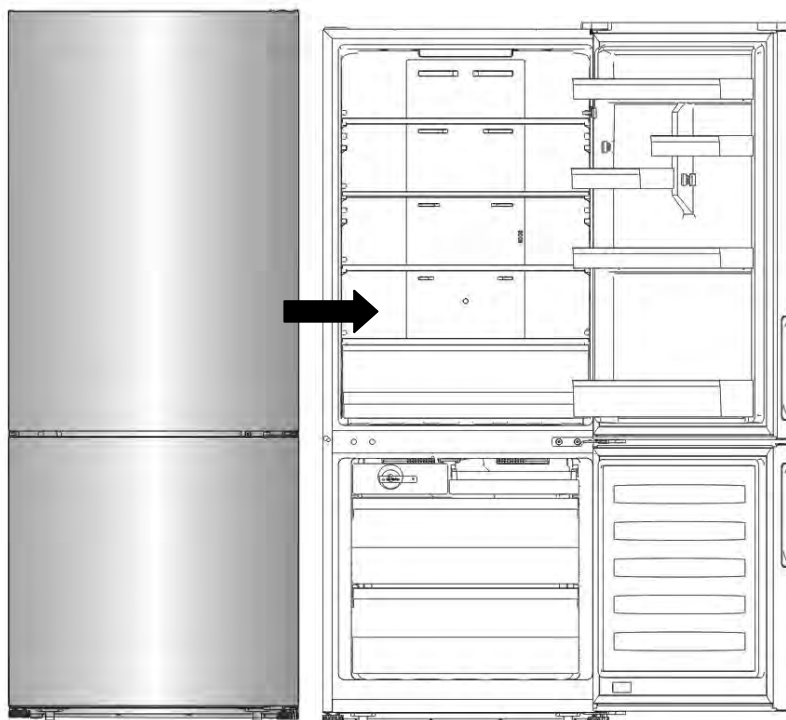

Controlling the temperature

We recommend that when you start your refrigerator for the first time, the temperature for the refrigerator is set to 4°C and the freezer to -19°C. If you want to change the temperature, follow the instructions below.

Caution! When you set a temperature, you set an average temperature for the whole refrigerator cabinet. Temperatures inside each compartment may vary from the temperature displayed on the panel, depending on how much food you store and where you place them. Ambient temperature may also affect the actual temperature inside the appliance.



1. Fridge

Press the middle part of button to set fridge temperature between 2°C and 8°C as needed, and control panel will display corresponding figures according to the following sequence.

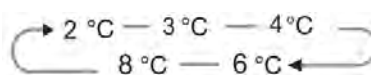

2. Freezer



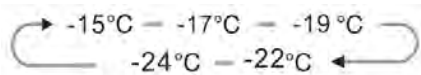

Press the middle part of button to set freezer temperature between -15°C and -24°C as needed, and control panel will display corresponding figures according to the

following sequence.



3. Super Freeze

Super Freeze will quickly lower the temperature within the freezer so food will freeze faster. This can lock in nutrients of food and keep food fresh for longer.

- Press the middle part of  button for 3 seconds to activate the super freeze function. The light  will turn on.
- Super freeze will automatically switch off after 52 hours.
- When super freeze function is on you can switch off super freeze function by pressing the middle part of  button and the freezer temperature setting will revert back to the previous setting.

4. Holiday



If you are going to be away for a long period of time, you can activate this function

by pressing the middle part  of button for 3 seconds until the light comes on.

When the holiday function is activated, the temperature of the refrigerator automatically switched to 15 °C to minimize the energy consumption. Important! Do not store any food in the fridge during this time. When holiday function is on, you can switch it off by pressing the middle part of button. The fridge temperature setting will revert back to the previous setting.

Using your appliance

Your appliance has the accessories as shown in “Description of the Appliance”. This section has instructions on how you can use them. We recommend that you read through carefully before using the appliance

Door rack

It is suitable for the storage of canned liquid, bottled drinks and packed food, etc. Do not place too many heavy things in the racks.

Shelf in Refrigerator chamber

1. There are shelves in refrigerator chamber, and they can be taken out to be cleaned.



2. The crisper is suitable for storage of vegetables and fruit, etc.

To remove, pull the crisper out in level, Secondly tip up it then you can take out the crisper.

According to the opposite sequence you can position the crisper rightly.

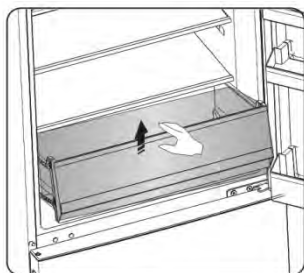
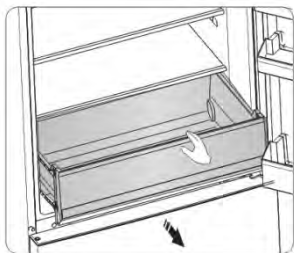

Freezer chamber

The freezer chamber is suitable for storage of foods required to be frozen, such as meat, ice.

Caution! Never close the freezer door while the drawers, installation bracket, ice tray are extended. It may damage the unit. Ensure that drink bottles are not left in the freezer for a longer time than needed as freezing liquid may cause the bottle to break.

Twistable ice tray

Twistable ice tray produce and store abundant ice cubes.

1. Pull out the twistable ice tray from the installation bracket.
2. Fill with drinking water below the maximum level mark.
3. Place the filled ice tray back to bracket.
4. Wait for around 3 hours, twist the knobs clockwise and the ice will drop into the ice box below.

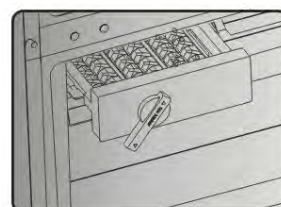
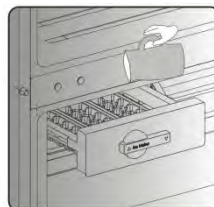
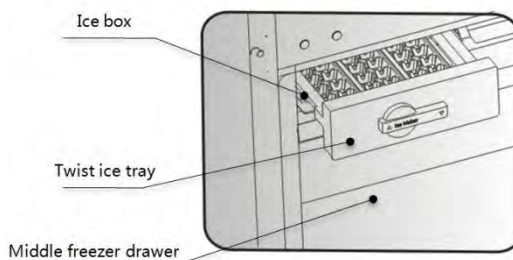

Cleaning and care

For hygienic reasons the appliance (including exterior and interior accessories) should be cleaned regularly (at least every two months).

Warning!

The appliance must not be connected to the mains during cleaning as there is a danger of electrical shock! Before cleaning, switch the appliance off and remove the plug from the main socket.

Exterior cleaning

Wipe the control panel with a clean, soft cloth.

- Spray water onto the cleaning cloth instead of spraying directly on the surface of the appliance. This helps ensure an even distribution of moisture to the surface.
- Clean the doors, handles and cabinet surfaces with a mild detergent and then wiped dry with a soft cloth.



Caution!

- Don't use sharp objects as they are likely to scratch the surface.
- Don't use Thinner, Car detergent, Clorox, ethereal oil, abrasive cleansers or organic solvent such as Benzene for cleaning. They may damage the surface

of the appliance and may cause fire.

Interior cleaning

You should clean the appliance interior regularly. It will be easier to clean when food stocks are low. Wipe the inside of the fridge freezer with a weak solution of bicarbonate of soda, and then rinse with warm water using a wrung-out sponge or cloth. Wipe completely dry before replacing the shelves and baskets. Thoroughly dry all surfaces and removable parts before putting them back into place.

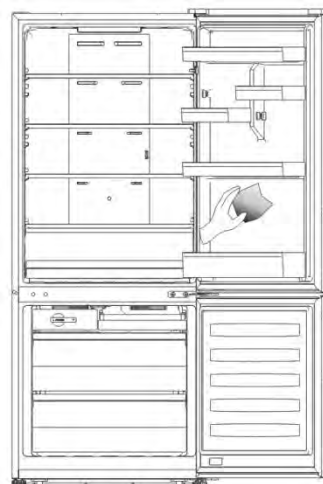

Although this appliance automatically defrosts, a layer of frost may occur on the freezer compartment's interior walls if the freezer door is opened frequently or kept open too long. If the frost is too thick, choose a time when the freezer is nearly empty and proceed as follows:

1. Remove existing food and accessories, unplug the appliance from the main power and leave the doors open. Ventilate the room thoroughly to accelerate the process.
2. When defrosting is complete, clean your freezer as described above.

Caution!

Do not use sharp objects to remove frost from the freezer compartment. Only after the interior is completely dry should the appliance be switched back on and plugged back into the main socket.

Door seals cleaning

Take care to keep door seals clean. Sticky food and drinks can cause seals to stick to the cabinet and tear when you open the door. Wash seal with a mild detergent and warm water. Rinse and dry it thoroughly after cleaning.

Caution! Only after the door seals are completely dry should the appliance be powered on

Replacing the LED light:

Warning:

The LED light should be replaced by a competent person. If the LED light is damaged, contact the customer helpline for assistance. To replace the LED light, the below steps can be followed:

1. Unplug your appliance.
2. Remove light cover by pushing up and out.
3. Hold the LED cover with one hand and pull it with the other hand while pressing the connector latch.
4. Replace LED light and snap it correctly in place.

Helpful hints and tips

Energy saving tips

We recommend that you follow the tips below to save energy.

- Try to avoid keeping the door open for long periods in order to conserve energy. Ensure the appliance is away from any sources of heat (Direct sunlight, electric oven or cooker etc)
- Don't set the temperature colder than necessary.
- Don't store warm food or evaporating liquid in the appliance.
- Place the appliance in a well ventilated, humidity free, room. Please refer to Installing your new appliance chapter.
- If the diagram shows the correct combination for the drawers, crisper and shelves, do not adjust the combination as this is designed to be the most energy efficient configuration.

Hints for fresh food refrigeration

- Do not place hot food directly into the refrigerator or freezer, the internal temperature will increase resulting in the compressor having to work harder and will consume more energy.
- Do cover or wrap the food, particularly if it has a strong flavour.
- Place food properly so that air can circulate freely around it.

Hints for refrigeration

- Meat (All Types) Wrap in polythene food: wrap and place on the glass shelf above the vegetable drawer. Always follow food storage times and use by dates suggested by manufacturers.
- Cooked food, cold dishes, etc.: They should be covered and may be

placed on any shelf.

- Fruit and vegetables:

They should be stored in the special drawer provided.

- Butter and cheese:

Should be wrapped in airtight foil or plastic film wrap.

- Milk bottles:

Should have a lid and be stored in the door racks.

Hints for freezing

- When first starting-up or after a period out of use, let the appliance run at least 2 hours on the higher settings before putting food in the compartment.
- Prepare food in small portions to enable it to be rapidly and completely frozen and to make it possible to subsequently thaw only the quantity required.
- Wrap up the food in aluminum foil or polyethylene food wraps which are airtight,
- Do not allow fresh, unfrozen food to touch the food which is already frozen to avoid temperature rise of the latter.
- Iced products, if consumed immediately after removal from the freezer compartment, will probably cause frost burns to the skin.
- It is recommended to label and date each frozen package in order to keep track of the storage time.

Hints for the storage of frozen food

- Ensure that frozen food has been stored correctly by the food retailer
- Once defrosted, food will deteriorate rapidly and should not be re-frozen. Do not exceed the storage period indicated by the

food manufacturer.

Switching off your appliance

If the appliance needs to be switched off for an extended period, the following steps should be taken prevent mould on the appliance.

1. Remove all food.
2. Remove the power plug from the main socket.
3. Clean and dry the interior thoroughly.
4. Ensure that all the doors are wedged open slightly to allow air to circulate.

Troubleshooting

If you experience a problem with your appliance or are concerned that the appliance is not functioning correctly, you can carry out some easy checks before calling for service, please see below.

Warning! Don't try to repair the appliance yourself. If the problem persists after you have made the checks mentioned below, contact a qualified electrician, authorized service engineer or the shop where you purchased the product.

Problem	Possible cause & Solution
Appliance is not working correctly	Check whether the power cord is plugged into the power outlet properly.
	Check whether the "Power" function is on by pressing the "power" button for 1 second.
	Check the fuse or circuit of your power supply, replace if necessary.
	It is normal that the freezer is not operating during the defrost cycle, or for a short time after the appliance is switched on to protect the compressor.
Odours from the compartments	The interior may need to be cleaned
	Some food, containers or wrapping cause odours.
Noise from the appliance	<p>The sounds below are quite normal:</p> <ul style="list-style-type: none"> •Compressor running noises. •Air movement noise from the small fan motor in the freezer compartment or other compartments. •Gurgling sound similar to water boiling. •Popping noise during automatic defrosting. •Clicking noise before the compressor starts.
	<p>Other unusual noises are due to the reasons below and may need you to check and take action:</p> <ul style="list-style-type: none"> •The cabinet is not level. •The back of appliance touches the wall. •Bottles or containers fallen or rolling.
The motor runs continuously	<p>It is normal to frequently hear the sound of the motor, it will need to run more when in following circumstances:</p> <ul style="list-style-type: none"> •Temperature setting is set colder than necessary •Large quantity of warm food has recently been stored within the appliance. •The temperature outside the appliance is too high. •Doors are kept open too long or too often. •After your installing the appliance or it has been switched off for a long time.

A layer of frost occurs in the compartment	Check that the air outlets are not blocked by food and ensure food is placed within the appliance to allow sufficient ventilation. Ensure that door is fully closed. To remove the frost, please refer to the “Cleaning and Care” chapter.
Temperature inside is too warm	You may have left the doors open too long or too frequently; or the doors are kept open by some obstacle; or the appliance is located with insufficient clearance at the sides, back and top
Temperature inside is too cold	Increase the temperature by following the “Display Controls” chapter.
Doors can't be closed easily	Check whether the top of the refrigerator is tilted back by 10-15mm to allow the doors to self-close, or if something inside is preventing the doors from closing.

Disposal of the appliance

It is prohibited to dispose of this appliance as household waste.

Packaging materials

Packaging materials with the recycle symbol are recyclable. Dispose of the packaging into a suitable waste collection container to recycle it.

Before disposal of the appliance

1. Pull out the main plug from the main socket.
2. Cut off the power cord and discard with the main plug.

Warning! Refrigerators contain refrigerant and gases in the insulation. Refrigerant and gases must be disposed of professionally as they may cause eye injuries or ignition. Ensure that tubing of the refrigerant circuit is not damaged prior to proper disposal.

Correct Disposal of this product	
	<p>This symbol on the product or in its packing indicates that this product may not be treated as household waste. Instead, it should be taken to the appropriate waste collection point for the recycling of electrical and electronic equipment. By ensuring this product is disposed of correctly, you will help prevent potential negative consequences for the environment and human health, which could otherwise be caused by the inappropriate waste handling of this product. For more detailed information about the recycling of this product, please contact your local council your household waste disposal service, or the shop where you purchased the product.</p>