

30" DUAL-FUEL AND GAS RANGES

JDS1450F, JGS1450F – 29⁷/₈" x 36" x 28⁵/₁₆"

PRODUCT DIMENSIONS

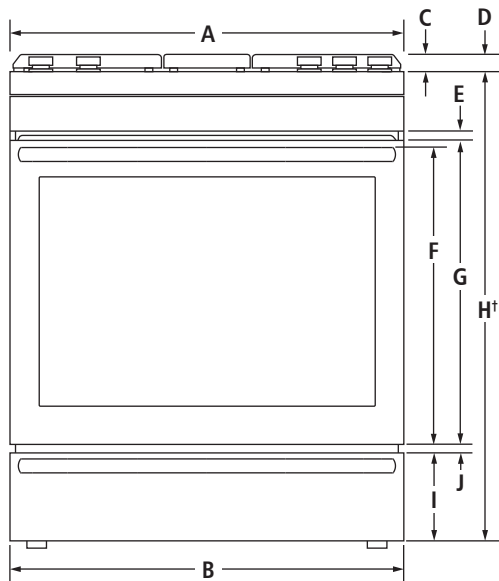

FRONT VIEW

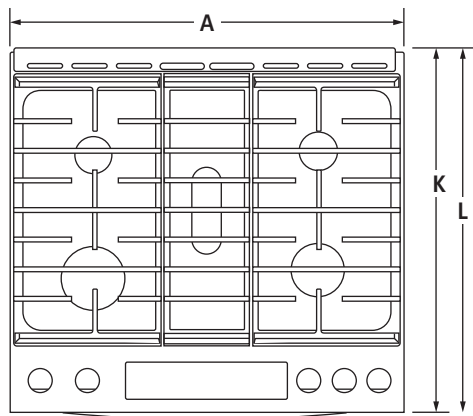

TOP VIEW

MODEL #		JDS1450F JGS1450F	
		in	cm
A	Overall width	29 ⁷ / ₈	75.9
B	Width of door/drawer	29 ⁷ / ₈	75.9
C	Height from cooktop to top of vent	1 ³ / ₁₆	3.0
D	Height with grates	37 ⁷ / ₈	96.2
	Height with vent*	37 ³ / ₈	95.0
E	Space between door and control panel	1 ³ / ₁₆	2.1
F	Height to top of handle Pro-Style® Stainless	22 ⁷ / ₈	58.1
	Euro-Style (color-coordinating)	22 ⁷ / ₈	58.1
G	Height of door	23 ¹ / ₄	59.0
H†	Height to top of cooktop edge	36	91.4
I	Height of warming drawer	6 ⁵ / ₁₆	16.0
J	Space between door and warming drawer	1 ³ / ₁₆	2.0
K	Depth from front of console to back of range (max.)	27 ¹³ / ₁₆	70.7
L	Depth from handle to back of range (max.) Pro-Style® Stainless	28 ¹⁵ / ₁₆	73.5
	Euro-Style (color-coordinating)	28 ⁵ / ₁₆	71.9

*Model JGS1450F.

†With leveling legs screwed all the way in. Range can be raised approximately 1" (2.5 cm) by adjusting the leveling legs.

IMPORTANT: Dimensional specifications are provided for planning purposes only. Do not make any cutouts based on this information. Refer to the Installation or Use & Care Guide before selecting cabinetry, verifying electrical/gas connections, making cutouts or beginning installation. All Jenn-Air® appliances are appropriately UL, CUL or CSA approved.

30" DUAL-FUEL AND GAS RANGES

JDS1450F, JGS1450F – 29⁷/₈" x 36" x 28⁵/₁₆"

DIMENSIONS AS INSTALLED

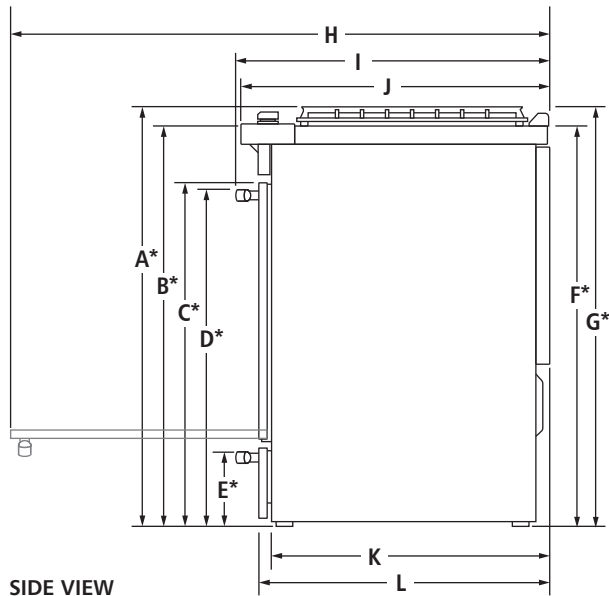

SIDE VIEW

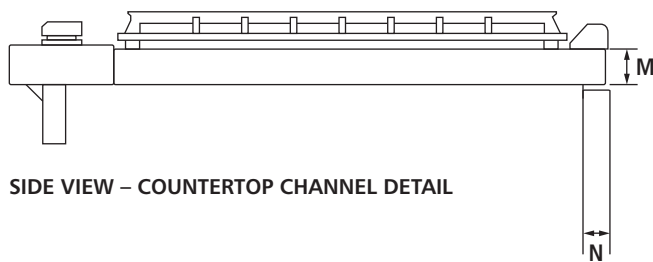

SIDE VIEW – COUNTERTOP CHANNEL DETAIL

MODEL #	JDS1450F JGS1450F	
	in	cm
A*	Height to top of grates (min.)	37 ⁷ / ₈ 96.2
B*	Height to top of cooking surface (min.)	35 ¹ / ₂ 90.2
C*	Height to top of door (min.)	30 ¹¹ / ₁₆ 78.0
D*	Height to top of handle (min.) Pro-Style® Stainless	30 ¹ / ₂ 77.5
	Euro-Style (color-coordinating)	30 ¹ / ₂ 77.5
E*	Height to top of warming drawer (min.)	6 ⁷ / ₈ 17.5
F*	Height to top of countertop (min.)	35 ¹³ / ₁₆ 91.0
G*	Height to top of vent (min.)**	37 ³ / ₈ 95.0
H	Depth with door fully open	50 ⁹ / ₁₆ 128.5
	Depth with handle Pro-Style® Stainless	28 ¹⁵ / ₁₆ 73.5
I	Euro-Style (color-coordinating)	28 ⁵ / ₁₆ 71.9
	Depth from front of console to back of range (max.)	27 ¹³ / ₁₆ 70.7
J	Depth without door	25 63.5
K	Depth with door	26 ⁵ / ₁₆ 66.8
L	Height of countertop channel	1 ¹³ / ₁₆ 4.6
M	Depth to countertop channel	1 ³ / ₁₆ 3.0
N		

*With leveling legs screwed all the way in. Range can be raised approximately 1" (2.5 cm) by adjusting the leveling legs.

**Model JGS1450F.

IMPORTANT: Dimensional specifications are provided for planning purposes only. Do not make any cutouts based on this information. Refer to the Installation or Use & Care Guide before selecting cabinetry, verifying electrical/gas connections, making cutouts or beginning installation. All Jenn-Air® appliances are appropriately UL, CUL or CSA approved.

30" DUAL-FUEL AND GAS RANGES

JDS1450F, JGS1450F – 29⁷/₈" x 36" x 28⁵/₁₆"

OPENING/CLEARANCE DIMENSIONS

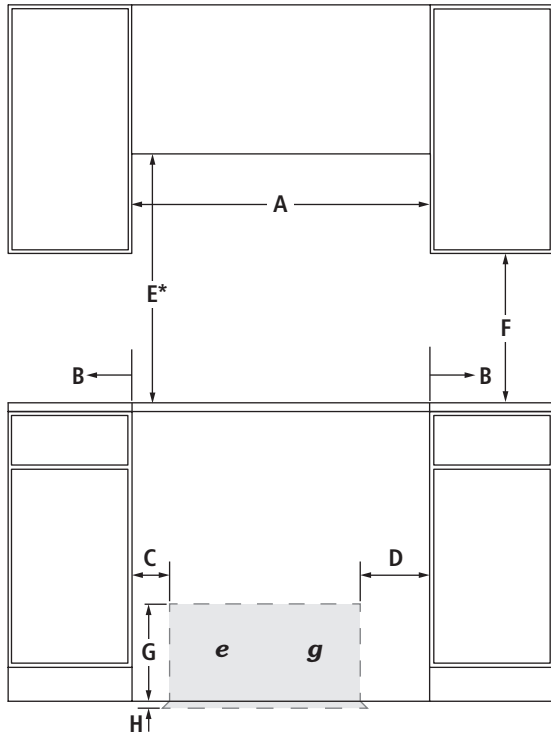

FRONT VIEW

MODEL #	JDS1450F JGS1450F	
	in	cm
A	Width of combustable area above cooking surface (min.)	30 76.2
B	Width from cooktop to fixed wall or other combustable material (min.)	3 7.6
C	Width from electrical installation area to cabinet (min.)	4 ¹³ / ₁₆ 12.2
D	Width from gas installation area to cabinet (min.)	12 30.5
E*	Height to bottom of uncovered wood or metal cabinet above cooking surface (min.)	30 76.2
F	Height to bottom of uncovered wood or metal cabinet (min.)	18 45.7
G	Height of electrical installation area (max.)	7 ¹ / ₁₆ 19.5
H	Depth of electrical installation area (max.)	3 ¹¹ / ₁₆ 9.4
I	Depth of upper cabinet (recommended)	13 33.0
J	Width of cutout (min.)	30 76.2
K	Width to power cord	2 ³ / ₄ 7.0
L	Width to gas inlet	17 ¹⁵ / ₁₆ 45.5
M	Height to gas inlet	4 ⁷ / ₁₆ 11.3
e	Recommended junction box location	
g	Recommended gas access location	

*Dimension can be reduced by 6" (15.2 cm) when bottom of wood or metal cabinet is covered by not less than ¼" (0.6 cm) flame retardant millboard covered with not less than No. 28 MSG sheet metal, 0.015" (0.4 mm) stainless steel, 0.024" (0.6 mm) aluminum or 0.020" (0.5 mm) copper.

If installing a hood or microwave hood combination above the range, follow the hood or microwave hood combination instructions for dimensional clearances above the cooking surface.

ELECTRICAL REQUIREMENTS

JDS1450F: 240 volt, 60 Hz, AC only, 40-amp fused, grounded circuit is required. A dedicated circuit is recommended. Minimum length of power cord is 48" (121.9 cm).

JGS1450F: 120 volt, 60 Hz, AC only, 15-amp fused, grounded circuit is required. A dedicated circuit is recommended. Minimum length of power cord is 48" (121.9 cm).

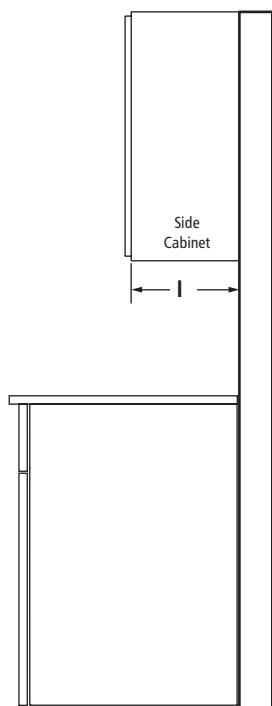

SIDE VIEW

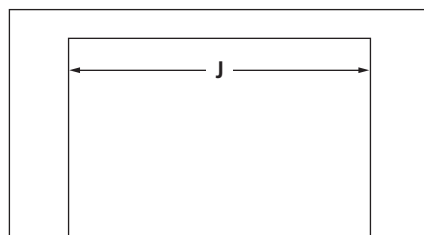

TOP VIEW – CUTOUT

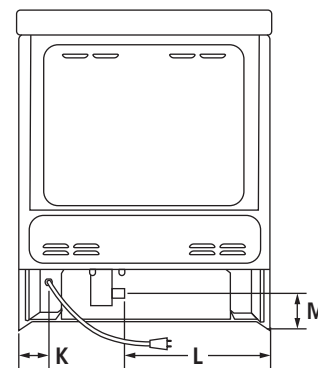

BACK VIEW

IMPORTANT: Dimensional specifications are provided for planning purposes only. Do not make any cutouts based on this information. Refer to the Installation or Use & Care Guide before selecting cabinetry, verifying electrical/gas connections, making cutouts or beginning installation. All Jenn-Air® appliances are appropriately UL, CUL or CSA approved.