

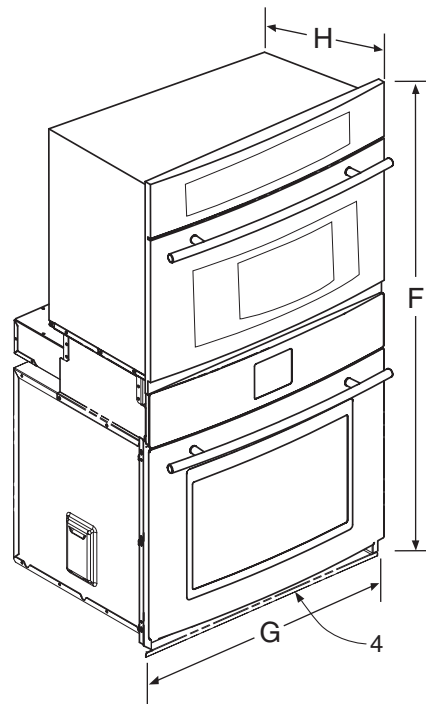

MICROWAVE WALL OVEN COMBO

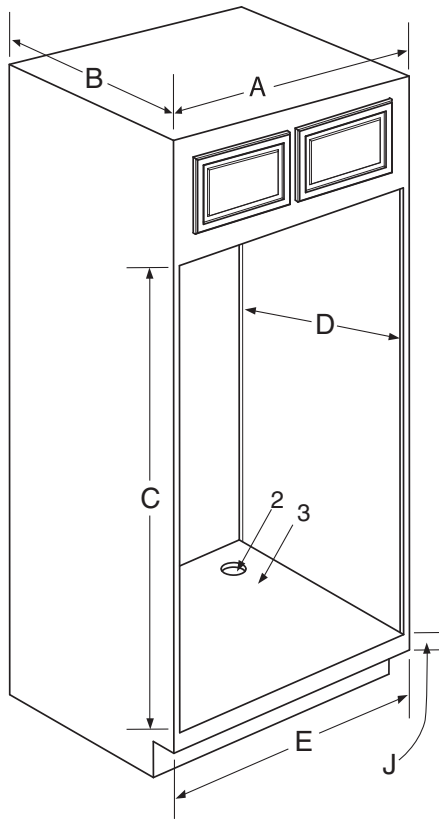

Style of product may vary from picture

PRODUCT DIMENSIONS

	INCHES	CENTIMETERS
A	30 min	76.2 min
B	24 min	61.0 min
C	51 7/8 ± 1/16	131.8 ± 0.1
D	24 min	61.0 min
E	28 1/2 ± 1/16	72.4 ± 0.1
F	52 15/16	134.5
G	29 3/4	75.6
H ¹	25 1/2	64.8
J	4 - 10	10.2 - 25.4

MODEL SKUs

JMW9530DAB
 JMW9530DAQ
 JMW9530DAS
 JMW9530DAW

NOTES:

1. Excluding door handle.
2. 1 1/4" Diameter Conduit Access Hole. Hole must be cut as close to corner of cabinet as possible.
3. 5/8" plywood floor (must support 310 pounds).
4. Do not block air intake slots along bottom of oven.
5. Installed combo wall oven overlaps the cut out 15/16" (2.4 cm) at the top and 1/8" (.3 cm) at the bottom. This must be taken into consideration when locating cutout if installed unit is to be centered in the cabinet.
6. These appliances have been designed in accordance with the requirements of various safety agencies and comply with the maximum allowable wood cabinet temperatures of 194° F. If these appliances are installed with cabinets that have a lower working temperature than 194° F, discoloration, delamination or melting may occur.

Electrical requirements: Provide for 120/240 or 120/208 VAC, 60 Hz.

See serial plate on front of unit for power requirements

Important: Because of continuing product improvements, Jenn-Air® reserves the right to change specifications without notice. Dimensional specifications are provided for planning purposes only. For complete details see installation instructions that accompany each product before selecting cabinetry, making cutouts or beginning installation.