

12" SOFFIT CHIMNEY

Model Number:	JXA9030CDP	JXA9036CDP	JXA9048CDP
Size:	30"	36"	48"

INSTALLATION GUIDE

TABLE OF CONTENTS

List of Materials.....	1
Installation.....	2-3



LIST OF MATERIALS

1

- 1 - Center panel
 - 2 - Side Panels
 - 12 - Philips head metal screws
-

INSTALLATION

2

INSTALLATION INSTRUCTIONS

1. Line up screw holes and attach the left and right side panels to the center panel with screws provided.

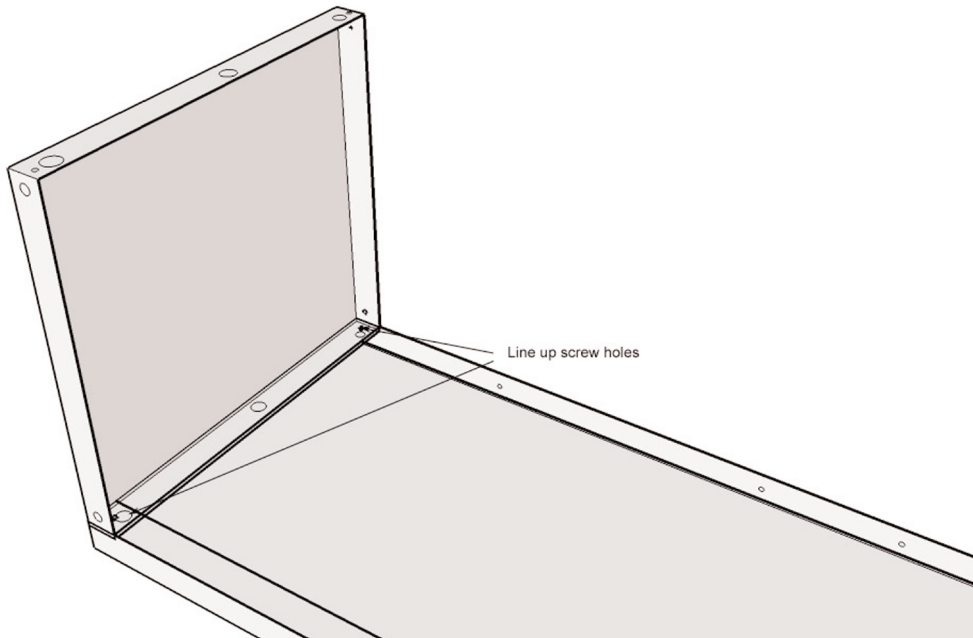

1. Place assembled soffit on top of range hood. Make sure the screw holes of the center panel are facing down and line up with the holes on top of the range hood.
2. Attach the soffit to the top of the range hood by securing the rest of the screws to it from within the hood shell.

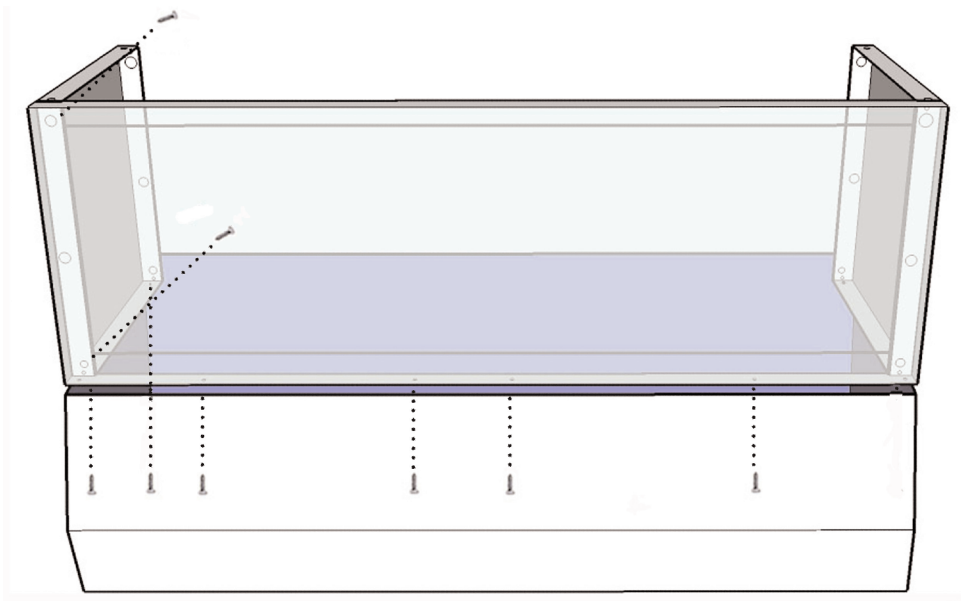

INSTALLATION

3

INSTALLATION INSTRUCTIONS

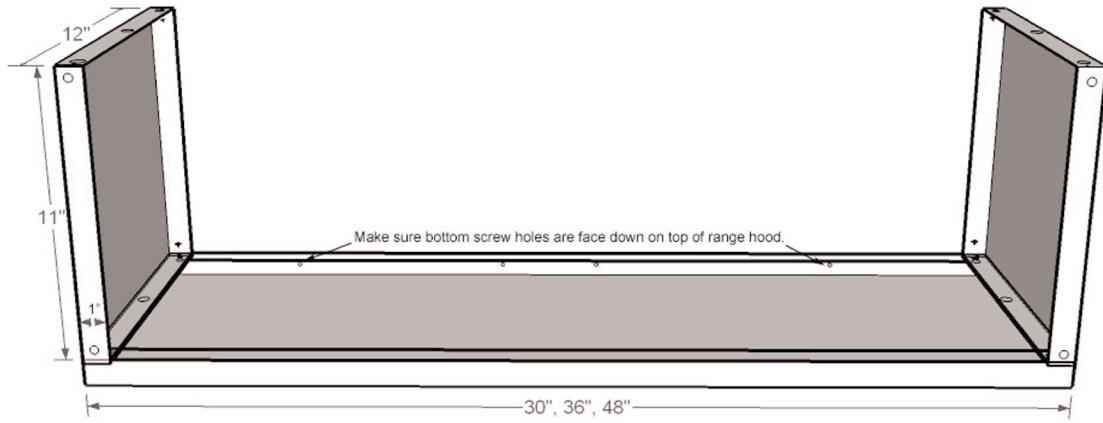

CHIMENEA TIPO SOFITO DE 12"

Número de Modelo:	JXA9030CDP	JXA9036CDP	JXA9048CDP
Instalación:	30"	36"	48"

INSTALLATION

GUIDE

LISTA DE MATERIALES

Lista de Materiales.....	1
Instalación.....	2-3



LISTA DE MATERIALES

1

- 1 - Panel central
 - 2 - Paneles laterales
 - 12 - Tornillos para metal tipo Phillips
-

INSTRUCCIONES PARA LA INSTALACION

1. Ponga en línea los orificios para los tornillos y sujete los paneles de la izquierda y la derecha al panel central con los tornillos que se proveen.

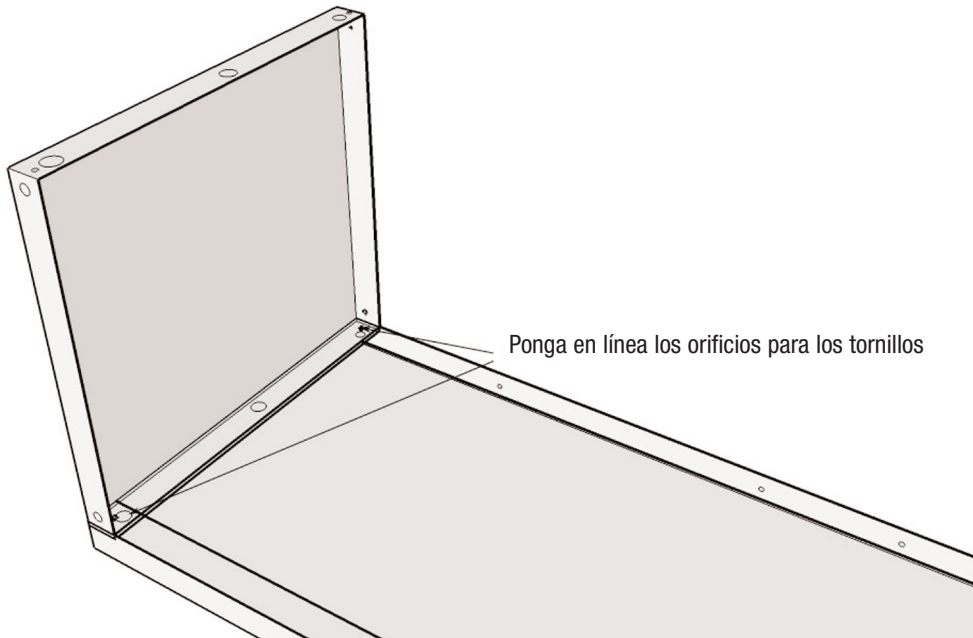

2. Ubique el soffito ya armado sobre la campana de cocina. Asegúrese de que los orificios para tornillos del panel central del soffito estén hacia abajo y alineados con los orificios de la parte superior de la campana de cocina.
3. Sujete el soffito a la parte superior de la campana de cocina atornillando los tornillos restantes desde el interior del casco de la campana.

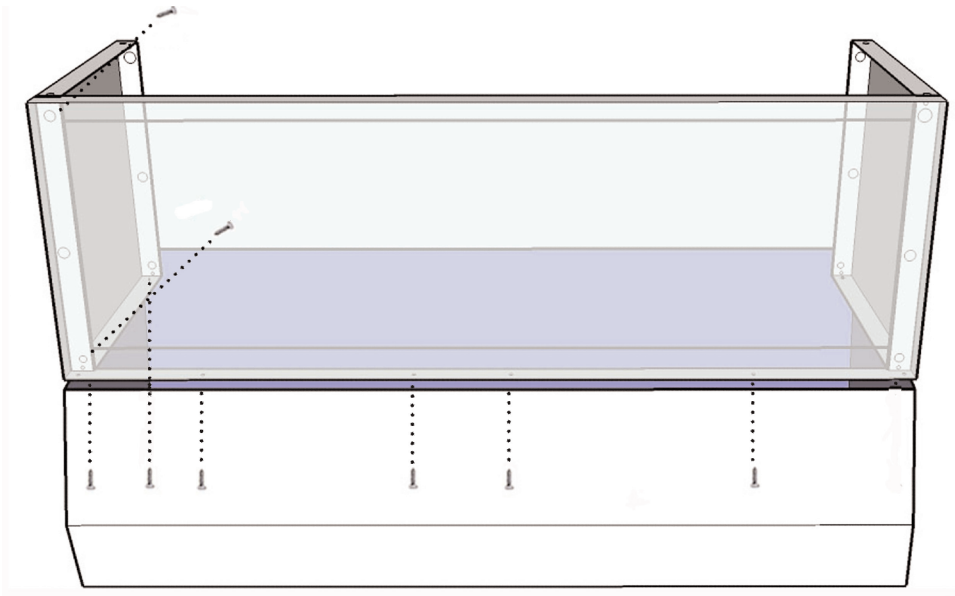

INSTALACION

3

INSTRUCCIONES PARA LA INSTALACION

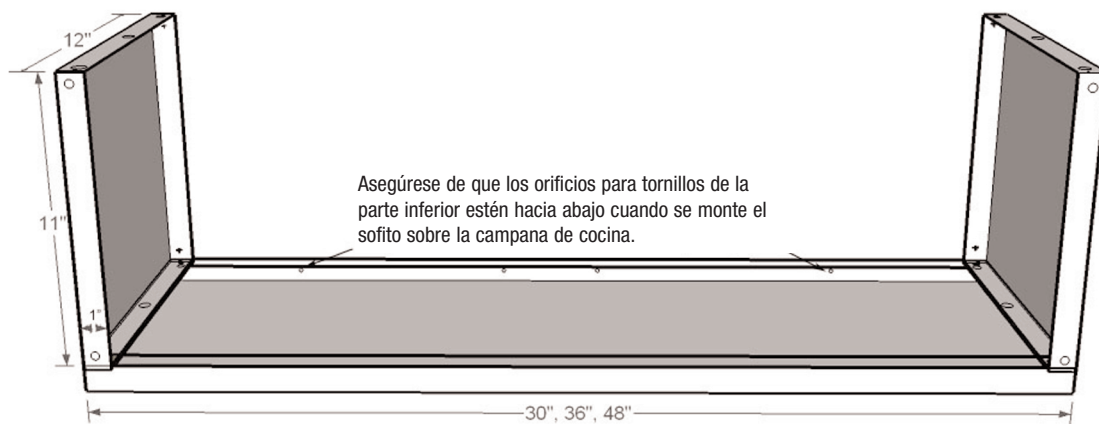

12" SOFFIT CHIMNEY

Numéro de modèle:	JXA9030CDP	JXA9036CDP	JXA9048CDP
Dimensions:	30"	36"	48"

INSTALLATION

GUIDE

TABLE DES MATIÈRES

Liste du matériel.....	1
Installation.....	2-3



LISTE DU MATÉRIEL

1

- 1 - Panneau central
 - 2 - Panneaux latéraux
 - 12 - Vis à tête cruciforme
-

MODE D'EMPLOI POUR L'INSTALLATION

1. Aligned les trous de montages et attachez les panneaux latéraux gauche et droit au panneau central avec les vis fournies.

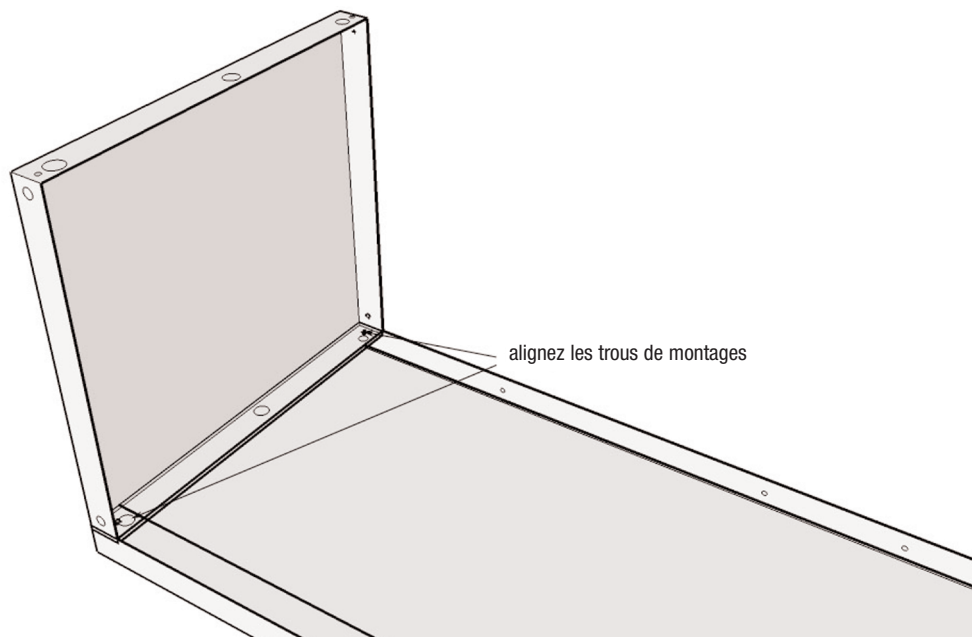

2. Placez le panneau de coffrage assemblé sur la hotte. Assurez vous que les trous de montage du panneau central sont tournés vers le bas et aligné aux trous de montage au dessus de la hotte.
3. Attachez le panneau de coffrage à la partie supérieure de la hotte en serrant le reste des vis depuis l'intérieur du coffre de la hotte.

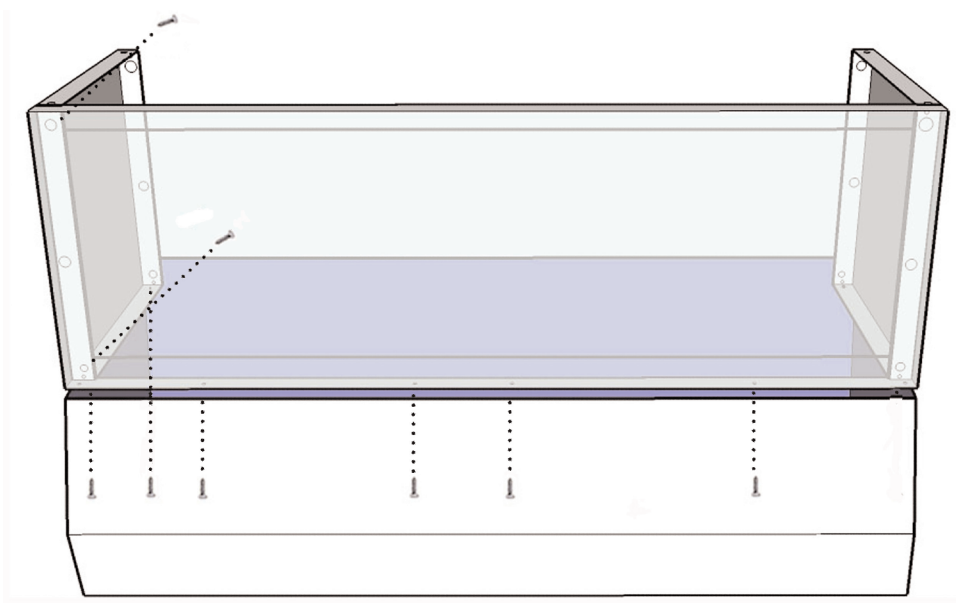

INSTALLATION

3

MODE D'EMPLOI POUR L'INSTALLATION

