

36" GAS COOKTOP

JGC1536AD – 36" x 5¼" x 21"

PRODUCT DIMENSIONS

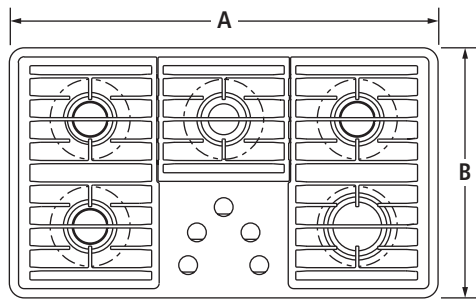

TOP VIEW

MODEL #		JGC1536AD	
		in	cm
<b>A</b>	Overall width	36	91.4
<b>B</b>	Overall depth	21	53.3
<b>C</b>	Center of cooktop to center of gas inlet	15¼	38.7
<b>D</b>	Width of recessed cooktop	34¾	87.3
<b>E</b>	Height with grates	2¼	5.8
<b>F</b>	Height of recessed cooktop	3⅞	9.7
<b>G</b>	Height from gas inlet to countertop	5¼	13.3
<b>H</b>	Center of gas inlet to recessed cooktop	1⅞	4.7
<b>I</b>	Depth of recessed cooktop	18¾	47.7

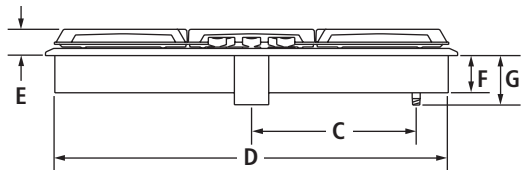

FRONT VIEW

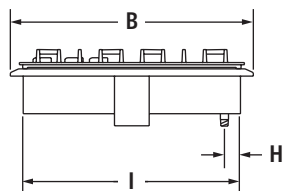

SIDE VIEW

36" GAS COOKTOP

JGC1536AD – 36" x 5¼" x 21"

OPENING/CLEARANCE DIMENSIONS

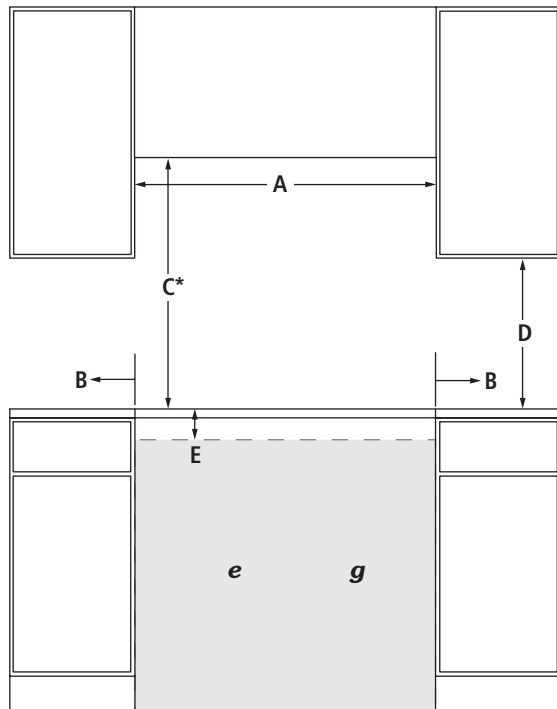

FRONT VIEW

MODEL #		JGC1536AD	
		in	cm
<b>A</b>	Width of combustible area above cooking surface (min.)	36	91.4
<b>B</b>	Width from cooktop to fixed wall or other combustibile material (min.)	6	15.2
<b>C*</b>	Height to bottom of uncovered wood or metal cabinet above cooking surface (min.)	30	76.2
<b>D</b>	Height to bottom of uncovered wood or metal cabinet (min.)	18	45.7
<b>E</b>	Height to top edge of electrical and gas installation area	37/8	9.7
<b>F</b>	Depth of upper cabinet (recommended)	13	33.0
<b>G</b>	Depth from cutout to wall (min.)	1	2.5
<b>H</b>	Width of cutout	34½	87.6
<b>I</b>	Depth of cutout	197/8	50.6
<b>J</b>	Depth from cutout to front of countertop	21/8	5.4
<b>e</b>	Recommended electrical access location		
<b>g</b>	Recommended gas supply line location		

\*Dimension can be reduced by 6" (15.2 cm) when bottom of wood or metal cabinet is covered by not less than ¼" (0.6 cm) flame retardant millboard covered with not less than No. 28 MSG sheet metal, 0.015" (0.4 mm) stainless steel, 0.024" (0.6 mm) aluminum or 0.020" (0.5 mm) copper.

If installing a hood or microwave hood combination above the cooktop, follow the hood or microwave hood combination instructions for dimensional clearances above the cooking surface.

**GAS REQUIREMENTS**

**Natural Gas**

This cooktop is factory-set for use with natural gas.

**LP Gas Conversion**

Conversion must be done by a qualified service technician. To convert to LP gas, use the LP gas conversion kit provided with the cooktop.

**ELECTRICAL REQUIREMENTS**

120 volt, 60 Hz, AC only, 15-amp fused, grounded circuit is required. A time-delay fuse or dedicated circuit is recommended. Minimum power cord length is 46" (117.0 cm).

**LOCATION REQUIREMENTS**

- To ensure cooktop base clearance, cabinet side walls need to be wider than the cutout.
- If cabinet has a drawer, allow a 4" (10.2 cm) minimum clearance between countertop and top of drawer. Drawer depth may need to be shortened to avoid interfering with the regulator.

**COOKTOP OVER SINGLE WALL OVEN INSTALLATION REQUIREMENTS**

- For approved model number combinations, refer to the under counter label on the bottom of the cooktop burner box.
- To install a cooktop over a 30" single wall oven, refer to page 3.

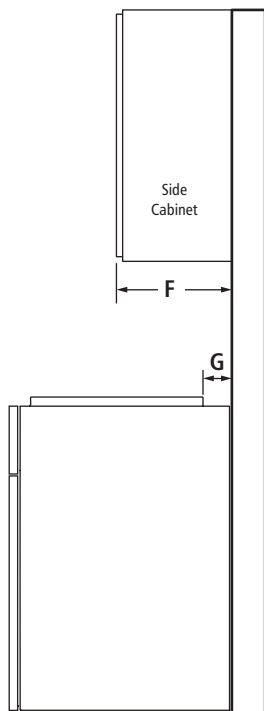

SIDE VIEW

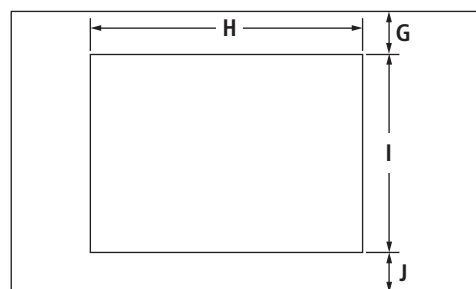

TOP VIEW – CUTOUT

Product dimension, cutout and installation specifications are provided for planning purposes only. Before installing any product, be sure to verify cutout dimensions and electrical/gas connections as actual product dimensions may vary.



SINGLE WALL OVEN AND COOKTOP COMBINATIONS

For the approved model number combinations, refer to the under counter label located on top of the oven chassis and on the bottom of the cooktop burner box.

APPROVED MODEL NUMBER COMBINATIONS

**SINGLE WALL OVENS**

30-Inch: JJW3430W, JJW2430W, JJW2330W  
 27-Inch: JJW2427W, JJW2327W

**INDUCTION COOKTOPS**

36-Inch: JIC4536X  
 30-Inch: JIC4430X

**GAS COOKTOPS**

36-Inch: JGC9536BD, JGC1536AD, JGC8536BD  
 30-Inch: JGC9430BD, JGC1430AD, JGC8430CD

**ELECTRIC COOKTOPS**

36-Inch: JEC4536Y, JEC9536BD, JEC8536BD  
 30-Inch: JEC4530Y, JEC9530BD, JEC8430BD

OPENING/CLEARANCE DIMENSIONS

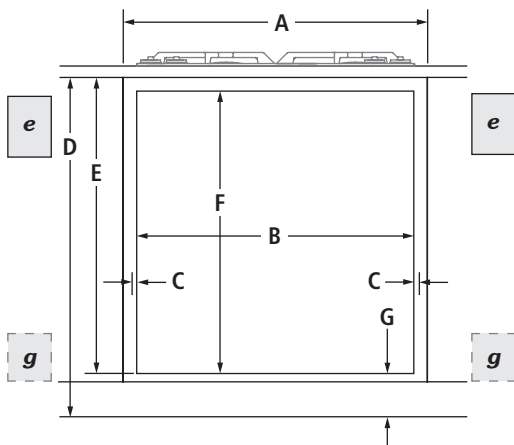

**FRONT VIEW –  
 UNDER COUNTER INSTALLATION**  
 (with cooktop installed above)

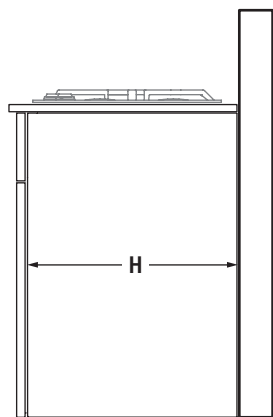

**SIDE VIEW –  
 UNDER COUNTER INSTALLATION**  
 (with cooktop installed above)

MODEL #	JJW3430W JJW2430W JJW2330W		JJW2427W JJW2327W	
	in	cm	in	cm
<b>A</b>	Width of cabinet (min.)			
<b>B</b>	Width of cutout (recommended)			
<b>C</b>	Oven trim overlap			
<b>D</b>	Bottom of countertop to floor			
<b>E</b>	Bottom of countertop to bottom of cutout			
	Induction cooktop combination			
	Gas cooktop combination			
<b>F</b>	Height of cutout (recommended)			
	Electric cooktop combination			
<b>G</b>	Bottom of cutout to floor			
	Induction cooktop combination			
	Gas cooktop combination			
<b>H</b>	Depth of cabinet (min.)			
	Electric cooktop combination			
<b>e</b>	Recommended junction box location			
<b>g</b>	Recommended gas supply line location for gas cooktop			

NOTE: For under counter installation, the junction box should be located in the adjacent right or left cabinet. Drill a 1" (2.5 cm) minimum diameter hole in an upper corner of the side wall for access to the junction box.

**CABINET REQUIREMENTS**

NOTE: When using under counter installation, check cabinet manufacturer's specifications to verify fit.

# JENN-AIR® DETAILED PLANNING DIMENSIONS

## VENTILATION SELECTION CHART – COOKTOPS

MODEL #	PRO-STYLE™ HOODS			EURO-STYLE ISLAND-MOUNT HOODS		EURO-STYLE WALL-MOUNT HOODS		GLASS COLLECTION ISLAND-MOUNT HOOD	GLASS COLLECTION WALL-MOUNT HOODS		PERIMETRIC HOOD	OILED BRONZE WALL-MOUNT HOODS		EURO-STYLE TELESCOPING DOWNDRAFT SYSTEMS		CUSTOM HOOD LINERS	OVER-THE-RANGE MICROWAVE OVENS
	JXW9048WP	JXW9036WP JXU9136WP	JXW9030WP JXU9130WP	JXI8042WS	JXI8036WS	JXW8036WS JXW8836WS	JXW8030WS	JXI5036WS	JXW5036WS	JXW5030WS	JXP5032WS	JXW6036WR	JXW6030WR	JXD7036YS	JXD7030YS	UXL6048YSSA UXL6036YSSA	JMV9186W JMV8208W
<b>INDUCTION COOKTOPS</b>																	
<b>36-INCH</b>																	
JIC4536X – 5 Elements	■	■	—	★	★	★	—	★	★	—	★	■	—	★	—	★	■
<b>30-INCH</b>																	
JIC4430X – 4 Elements	■	■	■	■	★	★	★	★	★	★	★	■	■	★	★	★	■
<b>CONVENTIONAL GAS COOKTOPS</b>																	
<b>36-INCH (less than 60,000 BTU total)</b>																	
JGC9536BD – 5 Burners	■	■	—	★	★	★	—	★	★	—	★	★	—	★	—	★	■
JGC1536AD – 5 Burners	■	■	—	★	★	★	—	★	★	—	★	■	—	★	—	★	■
JGC8536BD – 5 Burners	■	■	—	★	★	★	—	★	★	—	★	■	—	★	—	★	■
<b>30-INCH (less than 60,000 BTU total)</b>																	
JGC9430BD – 4 Burners	■	■	■	■	★	★	★	★	★	★	★	★	★	★	★	★	■
JGC1430AD – 4 Burners	■	■	■	■	★	★	★	★	★	★	★	■	■	★	★	★	■
JGC8430CD – 4 Burners	■	■	■	■	★	★	★	★	★	★	★	■	■	★	★	★	■
<b>CONVENTIONAL ELECTRIC COOKTOPS</b>																	
<b>36-INCH</b>																	
JEC4536Y – 5 Elements	■	■	—	★	★	★	—	★	★	—	★	■	—	★	—	★	■
JEC9536BD – 5 Elements	■	■	—	★	★	★	—	★	★	—	★	★	—	★	—	★	■
JEC8536BD – 5 Elements	■	■	—	★	★	★	—	★	★	—	★	■	—	★	—	★	■
<b>30-INCH</b>																	
JEC4530Y – 5 Elements	■	■	■	■	★	★	★	★	★	★	★	■	■	★	★	★	■
JEC9530BD – 5 Elements	■	■	■	■	★	★	★	★	★	★	★	★	★	★	★	★	■
JEC8430BD – 4 Elements	■	■	■	■	★	★	★	★	★	★	★	■	■	★	★	★	■

A. Custom hood liners can be used with any of the following blower motors: UXB1200DYS, UXB0600DYS, UXI1200DYS or UXI0600DYS.

KEY	
★	Style and Performance Pair
■	Performance Pair
—	Not Recommended

Product dimension, cutout and installation specifications are provided for planning purposes only. Before installing any product, be sure to verify cutout dimensions and electrical/gas connections as actual product dimensions may vary.

