



Network Blu-ray Disc Player Owner's Manual

Model: BD300

Before connecting, operating or adjusting this product,
please read this instruction booklet carefully and completely.



 As an ENERGY STAR® Partner, LG has determined that this product or product models meet the ENERGY STAR® guidelines for energy efficiency.

ENERGY STAR® is a U.S. registered mark.

For service/
support Call:
Toll Free Number
1-800-243-0000
(<http://us.lgservice.com>)

Netflix Support
If you need help for Netflix, please contact the following:
Call **1-866-579-7113** or
Visit www.netflix.com/LG/help



CAUTION: TO REDUCE THE RISK OF ELECTRIC SHOCK DO NOT REMOVE COVER (OR BACK) NO USER-SERVICEABLE PARTS INSIDE REFER SERVICING TO QUALIFIED SERVICE PERSONNEL.



This lightning flash with arrowhead symbol within an equilateral triangle is intended to alert the user to the presence of uninsulated dangerous voltage within the product's enclosure that may be of sufficient magnitude to constitute a risk of electric shock to persons.



The exclamation point within an equilateral triangle is intended to alert the user to the presence of important operating and maintenance (servicing) instructions in the literature accompanying the product.

WARNING: TO PREVENT FIRE OR ELECTRIC SHOCK HAZARD, DO NOT EXPOSE THIS PRODUCT TO RAIN OR MOISTURE.

WARNING: Do not install this equipment in a confined space such as a book case or similar unit.

CAUTION:

Do not block any ventilation openings. Install in accordance with the manufacturer's instructions.

Slots and openings in the cabinet are provided for ventilation and to ensure reliable operation of the product and to protect it from over heating.

The openings should never be blocked by placing the product on a bed, sofa, rug or other similar surface. This product should not be placed in a built-in installation such as a bookcase or rack unless proper ventilation is provided or the manufacturer's instruction have been adhered to.

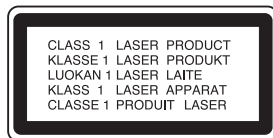

CAUTION:

This product employs a Laser System.

To ensure proper use of this product, please read this owner's manual carefully and retain it for future reference. Should the unit require maintenance, contact an authorized service center.

Use of any controls, adjustments, or procedures other than those specified herein may result in hazardous radiation exposure.

To prevent direct exposure to laser beam, do not try to open the enclosure. Visible laser radiation when open. **DO NOT STARE INTO BEAM.**

CAUTION: The apparatus should not be exposed to water (dripping or splashing) and no objects filled with liquids, such as vases, should be placed on the apparatus.

CAUTION concerning the Power Cord

Most appliances recommend they be placed upon a dedicated circuit;

That is, a single outlet circuit which powers only that appliance and has no additional outlets or branch circuits. Check the specification page of this owner's manual to be certain.

Do not overload wall outlets. Overloaded wall outlets, loose or damaged wall outlets, extension cords, frayed power cords, or damaged or cracked wire insulation are dangerous. Any of these conditions could result in electric shock or fire. Periodically examine the cord of your appliance, and if its appearance indicates damage or deterioration, unplug it, discontinue use of the appliance, and have the cord replaced with an exact replacement part by an authorized servicer.

Protect the power cord from physical or mechanical abuse, such as being twisted, kinked, pinched, closed in a door, or walked upon. Pay particular attention to plugs, wall outlets, and the point where the cord exits the appliance.

To disconnect power from the mains, pull out the mains cord plug. When installing the product, ensure that the plug is easily accessible.

FCC WARNING: This equipment may generate or use radio frequency energy. Changes or modifications to this equipment may cause harmful interference unless the modifications are expressly approved in the instruction manual. The user could lose the authority to operate this equipment if an unauthorized change or modification is made.

REGULATORY INFORMATION: FCC Part 15

This equipment has been tested and found to comply with the limits for a Class B digital device, pursuant to Part 15 of the FCC Rules. These limits are designed to provide reasonable protection against harmful interference when the product is operated in a residential installation. This product generates, uses, and can radiate radio frequency energy and, if not installed and used in accordance with the instruction manual, may cause harmful interference to radio communications. However, there is no guarantee that interference will not occur in a particular installation. If this product does cause harmful interference to radio or television reception, which can be determined by turning the product off and on, the user is encouraged to try to correct the interference by one or more of the following measures:

- Reorient or relocate the receiving antenna.
- Increase the separation between the product and receiver.
- Connect the product into an outlet on a circuit different from that to which the receiver is connected.
- Consult the dealer or an experienced radio/TV technician for help.

FCC COMPLIANCE: The responsible party for this product's compliance is:

LG Electronics U.S.A., Inc., 1000 Sylvan Avenue, Englewood Cliffs, NJ.

Phone: 1-201-816-2000.

Important Safety Instructions

1. Read these instructions.
2. Keep these instructions.
3. Heed all warnings.
4. Follow all instructions.
5. Do not use this apparatus near water.
6. Clean only with dry cloth.
7. Do not block any ventilation openings. Install in accordance with the manufacturer's instructions.
8. Do not install near any heat sources such as radiators, heat registers, stoves, or other apparatus (including amplifiers) that produce heat.
9. Do not defeat the safety purpose of the polarized or grounding-type plug. A polarized plug has two blades with one wider than the other. A grounding type plug has two blades and a third grounding prong. The wide blade or the third prong are provided for your safety. If the provided plug does not fit into your outlet, consult an electrician for replacement of the obsolete outlet.
10. Protect the power cord from being walked on or pinched particularly at plugs, convenience receptacles, and the point where they exit from the apparatus.
11. Only use attachments/accessories specified by the manufacturer.
12. Use only with the cart, stand, tripod, bracket, or table specified by the manufacturer, or sold with the apparatus. When a cart is used, use caution when moving the cart/apparatus combination to avoid injury from tip-over. 
13. Unplug this apparatus during lightning storms or when unused for long periods of time.
14. Refer all servicing to qualified service personnel. Servicing is required when the apparatus has been damaged in any way, such as power-supply cord or plug is damaged, liquid has been spilled or objects have fallen into the apparatus, the apparatus has been exposed to rain or moisture, does not operate normally, or has been dropped.

Contents

Introduction	5-11
About the  Symbol Display	5
Symbols Used in this Manual	5
Notes on Discs	5
Moisture Condensation	5
Handling the Unit	5
Playable Discs	6
Regional Code	6
BD-ROM Disc Features	7
Compatibility Notes	8
Certain System Requirements	8
Using an USB Device	9
Using the Home Menu	9

Front Panel	10
Display Window	10
Remote Control	11
Remote Control Operation	11

Installation and Setup

12-23	
Rear Panel	12
HDMI connection	13
Connections to Your TV	14
Connecting to an Amplifier	15
Internet connection	16
Resolution Setting	17-18
Initial Settings	19
- General Operation	19
- [DISPLAY] Menu	19
- [LANGUAGE] Menu	20
- [AUDIO] Menu	20
- [LOCK] Menu (Parental Control)	21
- [NETWORK] Menu	22
- [OTHERS] Menu	23

Operations

24-31	
General disc playback features	24-25
If a disc menu screen is displayed	26
Enlarge the playback image	26
Time Search	26
Skip Search	26
Marker Search	26
Using Color (A, B, C, D) Buttons	26
Last Scene Memory	26
Screen Saver	26
Displaying Disc Information On-Screen	27
Enjoying BD-LIVE™ or BONUS VIEW™ in BD-Video	28
Playing a DVD VR Format Disc	29
Playing an Audio CD or MP3/WMA files	30
Viewing a Photo file	31

Netflix Operation

32-34	
Activating your player	32
Using your player for Netflix	33-34

Reference

35-42	
Controlling a TV with the Supplied Universal Remote Control	35
To program the remote to control the TV using the manufacturer code	35
Code numbers of controllable TVs	36
Language Codes	37
Area Codes	37
Troubleshooting	38
Customer Support	38
Specifications	39
This unit's Audio Output Specifications	40
Software Update	41
Open source software notice	42

Notes on Copyrights

- Because AACS (Advanced Access Content System) is approved as content protection system for BD format, similar to use of CSS (Content Scramble System) for DVD format, certain restrictions are imposed on playback, analog signal output, etc., of AACS protected contents. The operation of this product and restrictions on this product may vary depending on your time of purchase as those restrictions may be adopted and/or changed by AACS after the production of this product.
Furthermore, BD-ROM Mark and BD+ are additionally used as content protection systems for BD format, which imposes certain restrictions including playback restrictions for BD-ROM Mark and/or BD+ protected contents. To obtain additional information on AACS, BD-ROM Mark, BD+, or this product, please contact an authorized Customer Service Center.
- Many BD-ROM/DVD discs are encoded with copy protection. Because of this, you should only connect your player directly to your TV, not to a VCR. Connecting to a VCR results in a distorted picture from copy-protected discs.
- This product incorporates copyright protection technologies that are protected by certain U.S. patents and other intellectual property rights owned by Macrovision Corporation and other rights owners. Use of this copyright protection technology must be authorized by Macrovision Corporation and is intended for home and other limited viewing uses only, unless otherwise authorized by Macrovision Corporation. Reverse engineering or disassembly is prohibited.
- Under the U.S. Copyright laws and Copyright laws of other countries, unauthorized recording, use, display, distribution, or revision of television programs, videotapes, BD-ROM discs, DVDs, CDs and other materials may subject you to civil and/or criminal liability.

Manufactured under license from Dolby Laboratories. Dolby and the double-D symbol are trademarks of Dolby Laboratories.

Manufactured under license under U.S. Patent #: 5,451,942; 5,956,674; 5,974,380; 5,978,762; 6,487,535 & other U.S. and worldwide patents issued & pending. DTS is a registered trademark and the DTS logos, Symbol, DTS-HD and DTS-HD Advanced Digital Out are trademarks of DTS, Inc. © 1996-2007 DTS, Inc. All Rights Reserved.

HDMI, the HDMI logo and High-Definition Multimedia Interface are trademarks or registered trademarks of HDMI licensing LLC.

“BD-LIVE” logo is trademark of Blu-ray Disc association.

“DVD Logo” is trademark of DVD Format/Logo Licensing Corporation.



What is SIMPLINK?

Some functions of this unit are controlled by the TV's remote control when this unit and LG TV's with SIMPLINK are connected through HDMI connection.

- Controllable functions by LG TV's remote control; Play, Pause, Scan, Skip, Stop, Power Off, etc.
- Refer to the TV owner's manual for the details of SIMPLINK function.
- LG TV's with SIMPLINK function have the logo as shown above.

Note:

Depending on the disc type or playing status, some SIMPLINK operation may differ from your purpose or not work.

Software Update

The software of the player can be updated by connecting it to the Internet using the LAN cable. We recommend to update the player using the latest software to enhance the products operation and/or add new features (see page 41).

To use BD-Live functionality

You must attach an external USB device using the USB port (see page 9).

Introduction

To ensure proper use of this product, please read this owner's manual carefully and retain for future reference.

This manual provides information on the operation and maintenance of your player. Should the unit require service, contact an authorized service location.

About the Symbol Display

“” may appear on your TV display during operation and indicates that the function explained in this owner's manual is not available on that specific media.

Symbols Used in this Manual

Note:

Indicates special notes and operating features.

Tip:

Indicates tips and hints for making the task easier.

A section whose title has one of the following symbols are applicable only to the disc represented by the symbol.

- BD** BD-ROM disc
- DVD** DVD-Video, DVD±R/RW in Video mode or VR mode and finalized
- AVCHD** DVD±R/RW in AVCHD format
- ACD** Audio CDs
- MP3** MP3 files
- WMA** WMA files
- PHOTO** Photo files

Notes on Discs

Handling Discs

Do not touch the playback side of the disc. Hold the disc by the edges so that fingerprints do not get on the surface. Never stick paper or tape on the disc.



Storing Discs

After playing, store the disc in its case. Do not expose the disc to direct sunlight or sources of heat and never leave it in a parked car exposed to direct sunlight.

Cleaning Discs

Fingerprints and dust on the disc can cause poor picture quality and sound distortion. Before playing, clean the disc with a clean cloth. Wipe the disc from the center out.

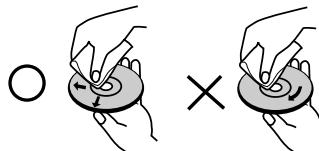

Do not use strong solvents such as alcohol, benzene, thinner, commercially available cleaners, or anti-static spray intended for older vinyl records.

Moisture Condensation

Never operate this product immediately after moving it from a cold location to a warm location. Leave it for two or three hours without operating it. If you use this product in such a situation, it may damage discs and internal parts.

Handling the Unit

When shipping the unit

Please save the original shipping carton and packing materials. If you need to ship the unit, for maximum protection, re-pack the unit as it was originally packed at the factory.

Keeping the exterior surfaces clean

Use the supplied cloth for cleaning the surfaces of the player.

- Do not use volatile liquids such as insecticide spray near the unit.
- Wiping with strong pressure may damage the surface.
- Do not leave rubber or plastic products in contact with the unit for a long period of time.

Cleaning the unit

To clean the player, use a soft, dry cloth. If the surfaces are extremely dirty, use a soft cloth lightly moistened with a mild detergent solution.

Do not use strong solvents such as alcohol, benzene, or thinner, as these might damage the surface of the unit.

Maintaining the Unit

The unit is a high-tech, precision device. If the optical pick-up lens and disc drive parts are dirty or worn, the picture quality could be diminished.

For details, please contact your nearest authorized service center.

Playable Discs



Blu-ray Disc

- Discs such as movies that can be purchased or rented
- BD-R/RE discs that contain audio titles, MP3, WMA, or Photo files.



DVD-VIDEO (8 cm / 12 cm disc)

- Discs such as movies that can be purchased or rented



DVD-R (8 cm / 12 cm disc)

- Video mode and finalized only
- Supports the dual layer disc also
- AVCHD format



DVD-RW (8 cm / 12 cm disc)

- VR mode, Video mode and finalized only
- AVCHD format



DVD+R (8 cm / 12 cm disc)

- Finalized disc only
- Supports the dual layer disc also
- AVCHD format



DVD+RW (8 cm / 12 cm disc)

- Video mode and finalized only
- AVCHD format



Audio CD (8 cm / 12 cm disc)

- Music CDs or CD-Rs/CD-RWs in music CD format that can be purchased



CD-R/CD-RW (8 cm / 12 cm disc)

- CD-R/CD-RW discs that contain audio titles, MP3, WMA, or Photo files.

AVCHD (Advanced Video Codec High Definition)

- This player can playback AVCHD format discs. These discs are normally recorded and used in camcorders.
- The AVCHD format is a high definition digital video camera format.
- The MPEG-4 AVC/H.264 format is capable of compressing images at higher efficiency than that of the conventional image compressing format.
- Some AVCHD discs use the "x.v.Color" format.
- This player can playback AVCHD discs using "x.v.Color" format.
- "x.v.Color" is a trademark of Sony Corporation.
- "AVCHD" and the AVCHD logo are trademarks of Matsushita Electronic Industrial Co., Ltd. and Sony Corporation.
- Some AVCHD format discs may not play, depending on the recording condition.
- AVCHD format discs need to be finalized.
- "x.v.Color" offers a wider color range than normal DVD camcorder discs.

Regional Code

This unit has a regional code printed on the rear of the unit. This unit can play only BD-ROM or DVD discs labeled same as the rear of the unit or "ALL".

Notes:

- Depending on the conditions of the recording equipment or the CD-R/RW (or DVD±R/RW) disc itself, some CD-R/RW (or DVD±R/RW) discs cannot be played on the unit.
- Do not attach any seal or label to either side (the labeled side or the recorded side) of a disc.
- Do not use irregularly shaped CDs (e.g., heart-shaped or octagonal). Doing so may result in malfunctions.
- Depending on the recording software & the finalization, some recorded discs (CD-R/RW or DVD±R/RW) may not be playable.
- DVD±R/RW and CD-R/RW discs recorded using a personal computer or a DVD or CD Recorder may not play if the disc is damaged or dirty, or if there is dirt or condensation on the player's lens.
- If you record a disc using a personal computer, even if it is recorded in a compatible format, there are cases in which it may not play because of the settings of the application software used to create the disc. (Check with the software publisher for more detailed information.)
- This player requires discs and recordings to meet certain technical standards in order to achieve optimal playback quality. Pre-recorded DVDs are automatically set to these standards. There are many different types of recordable disc formats (including CD-R containing MP3 or WMA files) and these require certain pre-existing conditions to ensure compatible playback.
- Customers should note that permission is required in order to download MP3 / WMA files and music from the Internet. Our company has no right to grant such permission. Permission should always be sought from the copyright owner.

BD-ROM Disc Features

BD-ROM Discs can store 25 GB (single layer) or 50 GB (dual layer) on a single sided disc - about 5 to 10 times the capacity of a DVD.

BD-ROM Discs also support the highest quality HD video available in the industry (up to 1920 x 1080) - Large capacity means no compromise on video quality. Furthermore, a BD-ROM disc has the same familiar size and look as DVD.

- The following BD-ROM disc features are disc dependent and will vary.
- Appearance and navigation of features will also vary from disc to disc.
- Not all discs will have the features described below.
- BD-ROM, Hybrid disc have both BD-ROM and DVD (or CD) layers on one side. On such discs, BD-ROM layer will be only played back in this player.

Video highlights

The BD-ROM format for movie distribution supports three highly advanced video codecs, including MPEG-2, MPEG4 AVC (H.264), and SMPTE VC1. HD video resolutions are also available:

- 1920 x 1080 HD
- 1280 x 720 HD

For High-Definition Playback

To view high-definition contents from BD-ROM discs, an HDTV is required. Some discs may require HDMI OUT for viewing of high-definition contents. Ability to view high-definition contents in BD-ROM discs may be limited depending on the resolution of your TV.

Graphic planes

Two individual, full HD resolution (1920x1080) graphic planes (layers) are available, on top of the HD video layer. One plane is assigned to video-related, frame accurate graphics (like subtitles), and the other plane is assigned to interactive graphic elements, such as buttons or menus.

For both planes, various wipes, fades and scroll effects may be available.

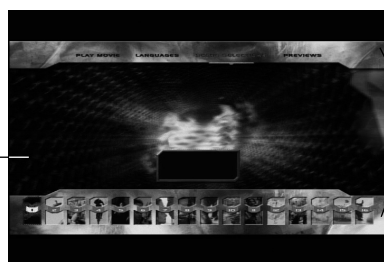

Graphic Plane

HD Video

Menu sounds

When you highlight or select a menu option, sounds can be heard such as button clicks or a voice-over explaining the highlighted menu choice.

Multi-page/PopUp Menus

With DVD-Video, playback is interrupted each time a new menu screen is accessed. Due to BD-ROM disc's ability to preload data from the disc without interrupting playback, a menu can consist of several pages.

You can browse through the menu pages or select different menu paths, while the audio and video remain playing in the background.

Interactivity

Certain BD-ROM Discs may contain animated menus and/or trivia games.

User Browsable Slideshows

With BD-ROM Discs, you can browse through various still pictures while the audio remains playing.

Subtitles

Depending on what is contained on the BD-ROM disc, you may be able to select different font styles, sizes and colors for some subtitles. Subtitles may also be animated, scrolled or faded in and out.

BD-J Interactive Capability

The BD-ROM format supports Java for interactive functions. "BD-J" offers content providers almost unlimited functionality when creating interactive BD-ROM titles.

BD-ROM Disc Compatibility

This player supports BD-ROM Profile 2.

- Discs supporting BD-Live (BD-ROM version 2 Profile 2) that allows interactive functions to be used when this unit is connected to the Internet in addition to the BONUSVIEW function.
- Discs supporting BONUSVIEW (BD-ROM version 2 Profile 1 version 1.1/Final Standard Profile) that allows Virtual packages or Picture-in-Picture functions to be used.

Compatibility Notes

- Because BD-ROM are a new format, certain disc, digital connection and other compatibility issues are possible. If you experience compatibility problems, please contact an authorized Customer Service Center.
- Viewing high-definition content and up-converting standard DVD content may require an HDMI-capable input or HDCP-capable DVI input on your display device.
- Some BD-ROM and DVD discs may restrict the use of some operation commands or features.
- Dolby TrueHD, Dolby Digital Plus and DTS-HD are supported with maximum 7.1 channels if you use HDMI connection for the audio output of the unit.
- You can use the USB device that is used to store some disc related information, including downloaded on-line content. The disc you are using will control how long this information is retained.

Certain System Requirements

For high definition video playback:

- High definition display that has COMPONENT or HDMI input jacks.
- BD-ROM disc with high definition content.
- HDMI or HDCP capable DVI input on your display device is required for some content (as specified by disc authors).
- For up-conversion of standard definition DVD, an HDMI or HDCP capable DVI input on your display device is required for copy protected content.

For Dolby® Digital Plus, Dolby TrueHD and DTS-HD multi-channel audio playback:

- An amplifier/receiver with a built-in (Dolby Digital, Dolby Digital Plus, Dolby TrueHD, DTS or DTS-HD) decoder.
- Main, center, surround speakers and subwoofer as necessary for chosen format.

Using an USB Devices

This unit can play the music and photo files contained in the USB device.

Inserting/Removing the USB Device

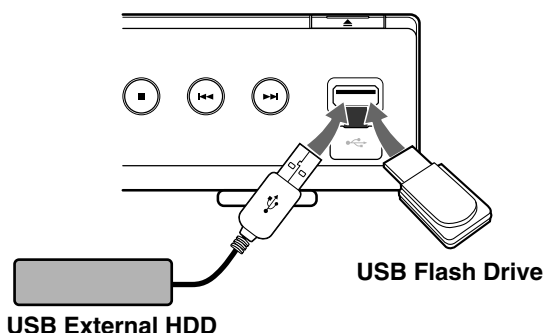

Inserting the USB device

Insert straight-in until it fits into place.

Removing the USB device

Withdraw the USB device or cable carefully.

Notes:

- This unit supports only USB Flash Drive and USB External HDD with FAT16 or FAT32 format.
- The USB device can be used for the local storage for enjoying BD-Live discs with Internet
- This unit can support up to 4 partitions of the USB device.
- Do not extract the USB device during operation (play, etc.).
- An USB device which requires additional program installation when you have connected it to a computer, is not supported.
- USB device: USB device that support USB1.1 and USB2.0.
- Music files (MP3/WMA) and photo files (JPEG/PNG) can be played.
For details of operations on each file, refer to relevant pages.
- Regular back up is recommended to prevent data loss.
- If you use a USB extension cable or USB HUB, the USB device may not be recognized.
- Some USB device may not work with this unit.
- Digital camera and mobile phone are not supported.
- USB Port of the unit cannot be connected to PC. The unit cannot be used as a storage device.

Using the USB Device

1. Connect a USB Device.
2. Press HOME on the Remote Control.
3. Select [Music] or [Photo] option then press ENTER.
4. Select [USB] then press ENTER.
MUSIC (or PHOTO) menu will appear.
Details for the menu are on pages 30-31.

Using the Home Menu

From the Home Menu screen you can access all the Media for playback and setting of the unit.

1. Press HOME and the Home Menu appears.

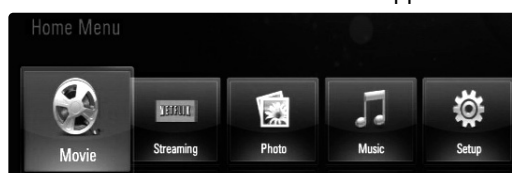

2. Use ◀ / ▶ to select the desired option then press ENTER.

[Movie] – Start video media's playback or displays MOVIE menu.

[Streaming] – Instantly watch some movies & TV episodes streamed from Netflix to your TV. (pages 32-34)

[Photo] – Displays PHOTO menu. (page 31)

[Music] – Displays MUSIC menu. (page 30)

[Setup] – Displays Setup menu. (page 19)

Tip:

If you select the [Photo] or [Music] option when the USB Device is connected and a disc is inserted simultaneously, the menu for selecting a media will appear. Select a media then press ENTER.

For example:

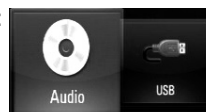

Tip:

If "Software Update" appears on the Home Menu, it means there is a software update available via network. To update the unit, press Blue color (D) button. For details, see page 41.

Notes:

- The unit will be in stop mode then HOME menu will appear if you press HOME during playback.
- If you insert a DVD or an unplayable disc that is formatted as ISO9660 or UDF, the [Photo] or [Music] option can be selected in the HOME menu. But you cannot play it

Front Panel

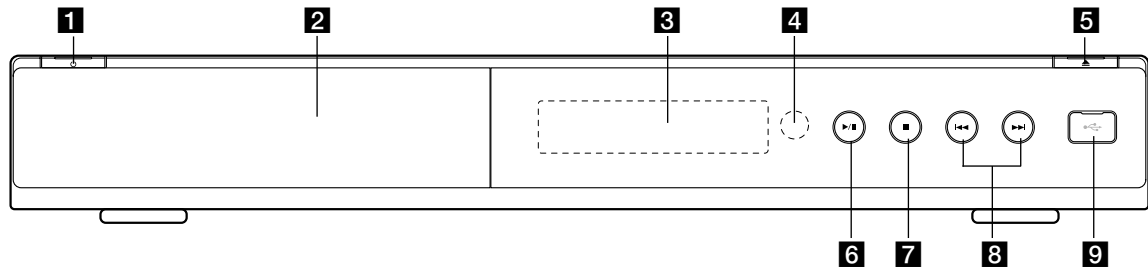

- 1** **⏻ (POWER) Button**
Switches the unit ON or OFF.
- 2** **Disc Tray**
Insert a disc here.
- 3** **Display Window**
Shows the current status of the player.
- 4** **Remote Sensor**
Point the Remote Control here.
- 5** **⏮ (OPEN/CLOSE)**
Opens or closes the disc tray.
- 6** **▶ / ⏸ (PLAY / PAUSE)**
Starts playback.
Pause playback temporarily, press again to exit pause mode.
- 7** **■ (STOP)**
Stops playback.
- 8** **⏮ / ⏭ (SKIP)**
Go to next or previous track/chapter.
- 9** **USB Port**
Connect a USB Device.

Display Window

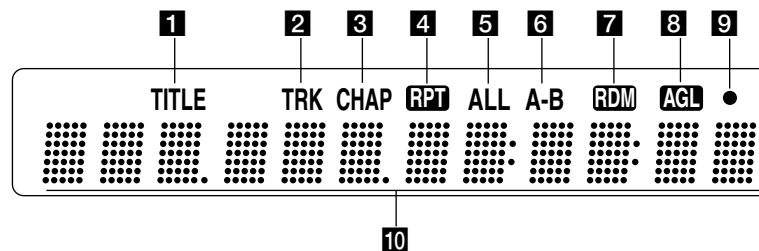

- 1** **TITLE Indicator**
Indicates current title number.
- 2** **TRK (Track) Indicator**
Indicates current track number.
- 3** **CHAP (Chapter) Indicator**
Indicates current chapter number.
- 4** **Repeat Mode Indicator**
Indicates when playing in repeat mode.
- 5** **ALL Repeat Mode Indicator**
Indicates when playing in all repeat mode.
- 6** **A-B Repeat Mode Indicator**
Indicates when playing in A-B repeat mode.
- 7** **RDM (Random) Indicator**
Indicates when playing in random order.
- 8** **AGL (Angle) Indicator**
Indicates when playing a scene recorded with multi angles.
- 9** **Remote Control Indicator**
Indicates when Remote Control signal is received.
- 10** **Character Indicators**
Indicates total playing time, elapsed time, title number, chapter number or message, etc.

Remote Control

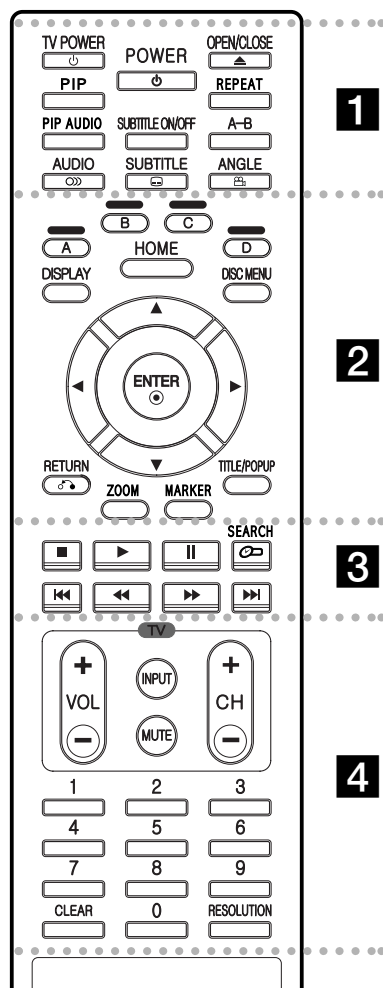

- • • • • **1** • • • • •
- POWER:** Switches the player ON or OFF.
- TV POWER:** Switches the TV ON or OFF.

OPEN/CLOSE (▲): Opens and closes the disc tray.

PIP*: Switches on/off Secondary Video (Picture-in-picture) (BD-ROM only).

REPEAT: Repeat a desired section.

PIP AUDIO*: Switch on/off Secondary Audio (BD-ROM only).

SUBTITLE ON/OFF: Switches the subtitle on or off.

A-B: Repeat sequence.

AUDIO (⊞): Selects an audio language or audio channel.

SUBTITLE (☐): Selects a subtitle language.

ANGLE (⊞): Selects a disc camera angle, if available.

1

2

3

4

• • • • • **2** • • • • •

Color (A, B, C, D) buttons: Use to navigate BD-ROM menus. They are also used for [PHOTO] and [MUSIC] menu.

DISPLAY: Displays or exits On-Screen Display.

HOME: Displays or exits Home Menu.

DISC MENU: Accesses menu on a disc.

Direction buttons: Select an option in the menu.

ENTER (⊙): Acknowledges menu selection.

RETURN (↶): Exits the menu or resumes playback. The resume play function may work depending on the BD-ROM disc.

ZOOM: Displays or exits the [ZOOM] menu.

MARKER: Marks any point during playback.

TITLE/POP UP: Displays the DVD title menu or BD-ROM's pop up menu, if available.

• • • • • **3** • • • • •

(STOP): Stops playback.

(PLAY): Starts playback.

(PAUSE/STEP): Pauses playback.

SEARCH: Displays or exits the search menu.

◀◀ / ▶▶ (SCAN): Search backward or forward.

◀◀◀ / ▶▶▶ (SKIP): Go to next or previous chapter.

• • • • • **4** • • • • •

TV Control Buttons: See page 35.

0-9 numerical buttons: Select numbered options in a menu.

CLEAR: Removes a mark on the search menu or a number when setting the password.

RESOLUTION: Sets the output resolution for HDMI and COMPONENT VIDEO OUT jacks.

* Depending on a disc type or the pre-recorded contents of the BD-ROM disc, different functions may be executed than other media or there are no responses when pressing some buttons (depending on media used).

Remote Control Operation

Point the Remote Control at the remote sensor and press the buttons.

Caution

Do not mix old and new batteries. Never mix different types of batteries (standard, alkaline, etc.).

Remote Control Battery Installation

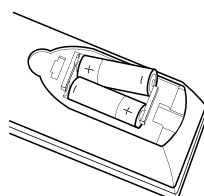

Remove the battery cover on the rear of the Remote Control, and insert two R03 (size AAA) batteries with **+** and **-** matched correctly.

Installation and Setup

Rear Panel

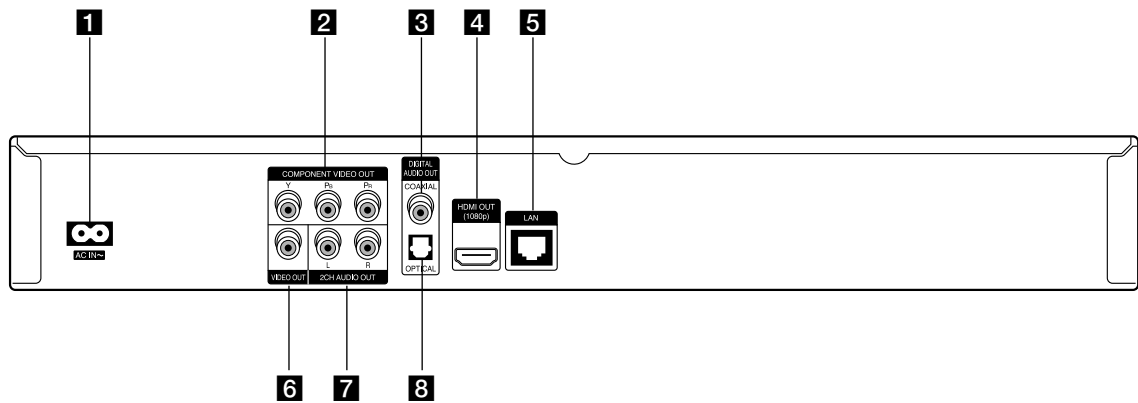

1 AC IN connector

Connect the supplied power cord.

2 COMPONENT VIDEO OUT (Y Pb Pr)

Connect to a TV with Y Pb Pr inputs.

3 DIGITAL AUDIO OUT (COAXIAL)

Connect to digital (coaxial) audio equipment.

4 HDMI OUT (Type A)

Connect to TV with HDMI inputs. (Interface for digital audio and video)

5 LAN port

Connect a network with an always-on broadband connection.

6 VIDEO OUT

Connect to a TV with video inputs.

7 2CH AUDIO OUT (Left/Right)

Connect to a TV with 2 channel audio inputs.

8 DIGITAL AUDIO OUT (OPTICAL)

Connect to digital (optical) audio equipment.

HDMI connection

If you have a HDMI TV or monitor, you can connect it to this player using a HDMI cable.

1. Connect the HDMI jack on the player to the HDMI jack on a HDMI compatible TV or monitor (**H**).
2. Set the TV's source to HDMI (refer to TV's Owner's manual).

Notes:

- You must select a HDMI audio output and a maximum sampling frequency that your TV accepts using [HDMI] and [Sampling Freq.] options on the setup menu (see page 20).
- If a connected HDMI device does not accept the audio output of the unit, the HDMI device's audio sound may be distorted or may not output.

Tips:

- When you use HDMI connection, you can change the resolution for the HDMI output. (Refer to "Resolution Setting" on page 17.)
- Select the type of video output from the HDMI OUT jack using [HDMI Color Setting] option on the setup menu (see page 19).

Cautions

- Changing the resolution when the connection has already been established may result in malfunctions. To solve the problem, turn off the player and then turn it on again.
- When the HDMI connection with HDCP is not verified, TV screen is changed to black screen. In this case, check the the HDMI connection, or disconnect the HDMI cable.
- If there is noise or lines on the screen, please check the HDMI cable (length is generally limited to 15ft).

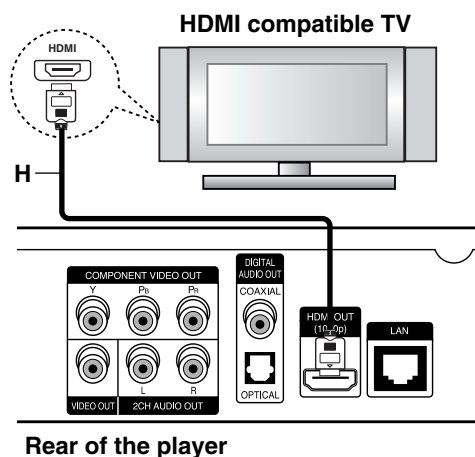

Additional Information for HDMI

- When you connect a HDMI or DVI compatible device make sure of the following:
 - Try switching off the HDMI/DVI device and this player. Next, switch on the HDMI/DVI device and leave it for around 30 seconds, then switch on this player.
 - The connected device's video input is set correctly for this unit.
 - The connected device is compatible with 720x480p, 1280x720p, 1920x1080i or 1920x1080p video input.
- Not all HDCP-compatible HDMI or DVI devices will work with this player.
 - The picture will not be displayed properly with non-HDCP device.
 - This player does not playback and TV screen is changed to black screen.

Connections to Your TV

Make one of the following connections, depending on the capabilities of your existing equipment.

Tips

- Depending on your TV and other equipment you wish to connect, there are various ways you could connect the player. Use only one of the connections described below.
- Please refer to the manuals of your TV, Stereo System or other devices as necessary to make the best connections.

Caution

- Make sure the player is connected directly to the TV. Tune the TV to the correct video input channel.
- Do not connect the player's AUDIO OUT jack to the phono in jack (record player) of your audio system.
- Do not connect your player via your VCR. The image could be distorted by the copy protection system.

Component Video Connection

Connect the COMPONENT VIDEO OUT jacks on the player to the corresponding input jacks on the TV using Y Pb Pr cables (**C**).

Tip:

When you use COMPONENT VIDEO OUT connection, you can change the resolution for the output. (Refer to "Resolution setting" on page 17.)

Video Connection

Connect the VIDEO OUT jack on the player to the video in jack on the TV using a video cable (**V**).

Audio (Left/Right) Connection

Connect the left and right AUDIO OUT jacks of the player to the audio left and right IN jacks on the TV using the audio cables (**A**).

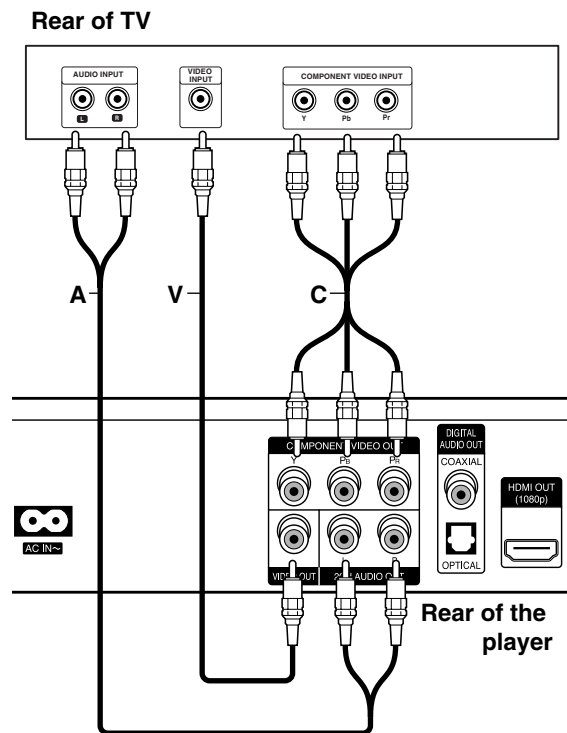

Connecting to an Amplifier

Make one of the following connections, depending on the capabilities of your existing equipment.

Note:

Since many factors affect the type of audio output, see "The unit's Audio Output Specifications" on page 40 for details.

Connecting to an Amplifier via 2 Channel Audio Output

Connect the Left and Right 2CH AUDIO OUT jacks on the player to the audio left and right in jacks on your amplifier, receiver, or stereo system, using audio cables (**A**).

Connecting to an Amplifier via Digital Audio Output (Optical or Coaxial)

1. Connect the player's DIGITAL AUDIO OUT jack to the corresponding in jack (OPTICAL **O** or COAXIAL **X**) on your amplifier. Use an optional digital (optical **O** or coaxial **X**) audio cable.
2. You will need to activate the player's digital output. (See "[AUDIO] Menu" on pages 20.)

Connecting to an Amplifier via HDMI Output

1. Connect the player's HDMI OUT jack to the corresponding in jack on your amplifier. Use an HDMI cable (**H1**).
2. You will need to activate the player's digital output. (See "[AUDIO] Menu" on pages 20.)

Tip:

Connect the amplifier's HDMI output jack to HDMI input jack on your TV using an HDMI cable (**H2**) if your amplifier has HDMI output jack.

Digital Multi-channel sound

A digital multi-channel connection provides the best sound quality. For this you need a multi-channel Audio/Video Receiver that supports one or more of the audio formats supported by your player. Check the receiver manual and the logos on the front of the receiver. (PCM Stereo, PCM Multi-Ch, Dolby Digital, Dolby Digital Plus, Dolby TrueHD, DTS and/or DTS-HD)

Notes:

- You must select a digital audio output and a maximum sampling frequency that your Amplifier (or AV receiver) accepts using [SPDIF], [HDMI] and [Sampling Freq.] options on the setup menu (see page 20).
- With digital audio connection (SPDIF or HDMI), Disc Menu button sounds of BD-ROM may not be heard if the [SPDIF] or [HDMI] option is set to [Primary Pass-Thru].
- If the audio format of the digital output does not match the capabilities of your receiver, the receiver will produce a strong, distorted sound or no sound at all.
- Multi-channel Digital Surround Sound via digital connection can only be obtained if your receiver is equipped with a Digital Multi-channel decoder.
- To see the audio format of the current disc in the on-screen display, press AUDIO.

Rear of the player

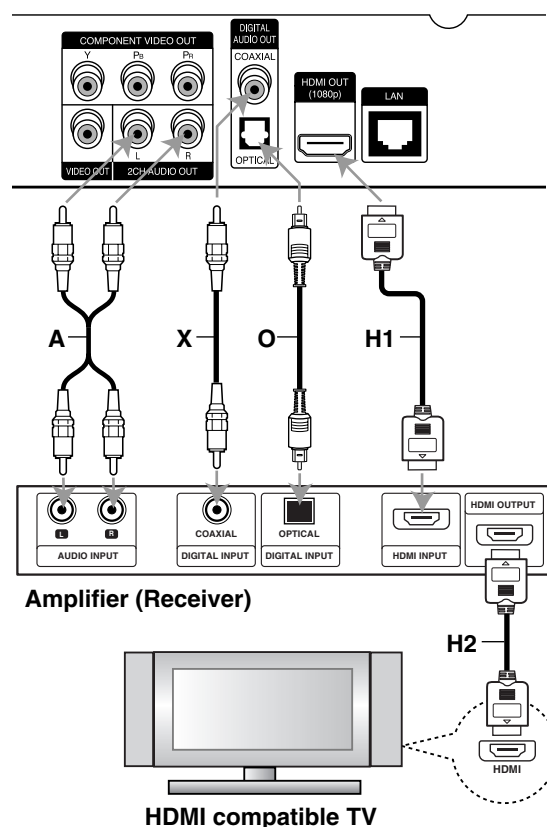

Internet connection

This player can be connected to a local area network (LAN) via the LAN port on the rear panel. After making the physical connection the player needs to be set up for network communication. This is done from the [Setup] menu — see “[NETWORK] Menu” on page 22 for detailed instructions.

Connect the player’s LAN port to the corresponding port on your Modem or Router using a LAN cable. Use a commercially available straight LAN cable (Category 5/CAT5 or better with RJ45 connector).

By connecting the unit to broadband Internet, you can use a disc that offers BD-Live function (see page 28).

Cautions:

- When plugging or unplugging the LAN cable, hold the plug portion of the cable. When unplugging, do not pull on the LAN cable but unplug while pressing down on the lock.
- Do not connect a modular phone cable to the LAN port.
- Since there are various connection configurations, please follow the specifications of your telecommunication carrier or internet service provider.

Rear of the player

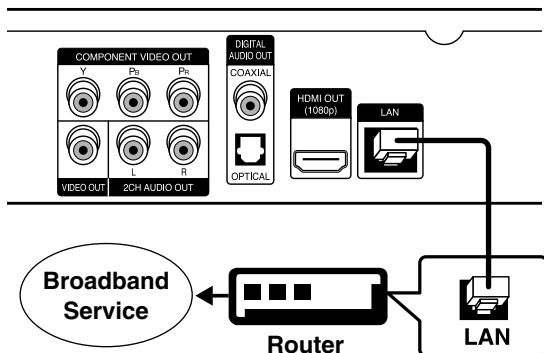

Notes:

- Depending on the internet service provider (ISP), the number of devices that can receive internet service may be limited by the applicable terms of service. For details, contact your ISP.
- Our company is not responsible for any malfunction of the player and/or the internet connection feature due to communication errors/malfunctions associated with your broadband internet connection, or other connected equipment.
- Our company is not responsible for any trouble in your internet connection.

- The features of BD-ROM discs made available through the Internet Connection feature are not created or provided by our company, and our company is not responsible for their functionality or continued availability. Some disc related material available by the Internet Connection may not be compatible with this player. If you have questions about such content, please contact the producer of the disc.
- Some internet contents may require a higher bandwidth connection.
- Even if the player is properly connected and configured, some internet contents may not operate properly because of internet congestion, the quality or bandwidth of your internet service, or problems at the provider of the content.
- Some internet connection operations may not be possible due to certain restrictions set by the Internet service provider (ISP) supplying your broadband Internet connection.
- Any fees charged by an ISP including, without limitation, connection charges are your responsibility.
- A 10 Base-T or 100 Base-TX LAN port is required for connection to this player. If your internet service does not allow for such a connection, you will not be able to connect the player.
- You must use a Router to use xDSL service.
- A DSL modem is required to use DSL service and a cable modem is required to use cable modem service. Depending on the access method of and subscriber agreement with your ISP, you may not be able to use the internet connection feature contained in this player or you may be limited to the number of devices you can connect at the same time. (If your ISP limits subscription to one device, this player may not be allowed to connect when a PC is already connected.)
- The use of a “Router” may not be allowed or its usage may be limited depending on the policies and restrictions of your ISP. For details, contact your ISP directly.
- Your ISP may protect this player from being connected to network when confirming MAC ADDRESS. In that case, contact your ISP to request to initialize MAC ADDRESS.

Resolution Setting

The player provides several output resolutions for HDMI OUT and COMPONENT VIDEO OUT jacks. You can change the resolution using [Setup] menu or pressing the RESOLUTION button in stop mode.

Note:

Since several factors affect the resolution of video output, see "Video output according to the Resolution setting" on next page.

Auto – If the HDMI OUT jack is connected for TVs providing display information (EDID), automatically selects the resolution best suited to the connected TV. If the COMPONENT VIDEO OUT is only connected, this changes the resolution to 1080i as default resolution.

1080p – Outputs 1080 lines of progressive video. (only for HDMI connection)

1080i – Outputs 1080 lines of interlaced video.

720p – Outputs 720 lines of progressive video.

480p – Outputs 480 lines progressive video.

480i – Outputs 480 lines of interlaced video.

How to change the resolution using RESOLUTION button

Press RESOLUTION button in stop mode.

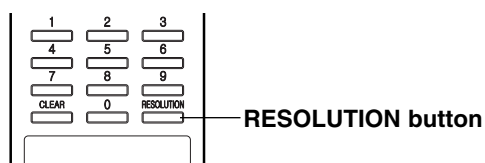

How to change the resolution using Setup menu

1. Press HOME and the Home Menu appears.
2. Select [Setup] and press ENTER. The Setup menu appears.
3. Use ▲ / ▼ to select [DISPLAY] option then press ► to move to the second level.
4. Use ▲ / ▼ to select the [Resolution] option then press ► to move to the third level.



5. Use ▲ / ▼ to select the desired resolution then press ENTER to confirm your selection.

Available resolution according to connection and media format

HDMI OUT connection

- For the 480i resolution setting, real output resolution of HDMI OUT will change to 480p.
- If you select a resolution manually and then connect the HDMI jack to TV and your TV does not accept it, the resolution setting is set to [Auto].
- If you select a resolution that your TV does not accept, the warning message will appear. After resolution change, if you cannot see the screen, please wait 20 seconds and the resolution will automatically revert back to the previous resolution.
- The 1080p video output frame rate may be automatically set to either 24Hz or 60Hz depending both on the capability and preference of the connected TV and based on the native video frame rate of the content on the BD-ROM disc.

COMPONENT VIDEO OUT connection

- For the 1080p resolution setting with unprotected media, real output resolution of COMPONENT VIDEO OUT will change to 1080i.
- For the 720p, 1080i, 1080p resolution setting with protected media, real output resolution of COMPONENT VIDEO OUT will change to 480i or 480p depending on the connectivity of HDMI cable.
- BD, DVD or Netflix video stream could prevent up-scaling on analog output.

VIDEO OUT connection

- The resolution of the VIDEO OUT jack is fixed to 480i.

Notes:

- Depending on your display, some of the resolution settings may result in the picture disappearing or an abnormal picture appearing. In this case, press HOME key then RESOLUTION repeatedly until the picture re-appear.
- This player supports simultaneous output of all video out jacks. The resolution of the HDMI output will not be the same as the resolution output on the component video output.

Video output according to the Resolution setting

• When the copy unprotected media is playing back

Video Output Resolution Setting	HDMI OUT	COMPONENT VIDEO OUT		VIDEO OUT
		HDMI connected	HDMI disconnected	
480i	480p	480i		480i
480p	480p	480p		480i
720p	720p	720p		480i
1080i	1080i	1080i		480i
1080p / 24Hz Mode	1080p / 24Hz Mode	480i	1080i	480i
1080p / 60Hz Mode	1080p / 60Hz Mode	480i	1080i	480i

• When the copy protected media is playing back

Video Output Resolution Setting	HDMI OUT	COMPONENT VIDEO OUT		VIDEO OUT
		HDMI connected	HDMI disconnected	
480i	480p	480i		480i
480p	480p	480p		480i
720p	720p	480i	480p	480i
1080i	1080i	480i	480p	480i
1080p / 24Hz Mode	1080p / 24Hz Mode	480i	480p	480i
1080p / 60Hz Mode	1080p / 60Hz Mode	480i	480p	480i

Initial Settings

By using the Setup menu, you can make various adjustments to items such as picture and sound. You can also set a language for the subtitles and the Setup menu, among other things. For details on each Setup menu item, see pages 19 to 23.

To display and exit the Menu:

Press HOME and the Home Menu appears. Select [Setup] then press ENTER, and Setup menu appears.

Press RETURN or HOME to exit the Setup menu.

To go to the next level:

Press ► on the Remote Control.

To go back to the previous level:

Press ◀ on the Remote Control.

General Operation

1. Press HOME and the Home Menu appears.
2. Select [Setup] and press ENTER. The Setup menu appears.



3. Use ▲ / ▼ to select the desired option then press ► to move to the second level. The screen shows the current setting for the selected item, as well as alternate setting(s).
4. Use ▲ / ▼ to select the second desired option then press ► to move to the third level.
5. Use ▲ / ▼ to select the desired setting then press ENTER to confirm your selection. Some items require additional steps.
6. Press RETURN or HOME to exit the Setup menu.

[DISPLAY] Menu



TV Aspect Ratio

[4:3 Letter Box] – Select when a standard 4:3 TV is connected. Displays theatrical images with masking bars above and below the picture.

[4:3 Pan Scan] – Select when a standard 4:3 TV is connected. Displays pictures cropped to fill your TV screen. Both sides of the picture are cut off.

[16:9 Wide] – Select when a 16:9 wide TV is connected.

Note:

You cannot select [4:3 Letter Box] and [4:3 Pan Scan] option when the resolution is set to higher than 720p.

Resolution

Sets the output resolution of the Component and HDMI video signal. Refer to “Resolution Setting” on page 17 for details about the resolution.

1080p Display Mode

When the resolution is set to 1080p, select [24Hz] for smooth presentation of film material (1080/24p) with an HDMI-equipped display compatible with 1080/24p input.

Notes:

- When you select [24Hz], you may experience some picture disturbance when the video switches video and film material. In this case, select [60Hz].
- Even when [1080p Display Mode] is set to [24Hz], if your TV is not compatible with 1080/24p, the actual frame frequency of the video output will be 60 Hz.

HDMI Color Setting

Select the type of output from the HDMI OUT jack. For this setting, please refer to the manuals of your display device.

[YCbCr] – Select when connecting to an HDMI display device.

[RGB] – Select when connecting to an RGB display device.

[LANGUAGE] Menu



Display Menu

Select a language for the Setup menu and on-screen display.

Disc Menu / Disc Audio / Disc Subtitle

Select the language you prefer for the audio track (disc audio), subtitles, and the disc menu.

[Original] – Refers to the original language in which the disc was recorded.

[Other] – Press ENTER to select another language. Use number buttons then ENTER to enter the corresponding 4-digit number according to the language code list on page 37.

[Off] (for Disc Subtitle) – Turn off Subtitle.

Note:

Depending on a disc, your language setting may not be worked for some disc.

[AUDIO] Menu

Each disc has a variety of audio output options. Set the player's Audio options according to the type of audio system you use.

Note:

Since many factors affect the type of audio output, see "The unit's Audio Output Specifications" on page 40 for details.



HDMI / SPDIF (Digital Audio Output)

Select the output sound format when a device equipped with an HDMI or Digital Audio input jack is connected to the HDMI OUT or DIGITAL AUDIO OUT jack on this player.

[PCM Stereo] – Select if you connect this unit's HDMI OUT or DIGITAL AUDIO OUT jack to a device with two-channel digital stereo decoder.

[PCM Multi-Ch] (HDMI only) – Select if you connect this unit's HDMI OUT jack to a device with multi-channel digital decoder.

[DTS Re-Encode] – Select if you connect this unit's HDMI OUT or DIGITAL AUDIO OUT jack to a device with DTS decoder.

[Primary Pass-Thru] – Select if you connect this unit's DIGITAL AUDIO OUT and HDMI OUT jack to a device with LPCM, Dolby Digital, Dolby Digital Plus, Dolby TrueHD, DTS and DTS-HD.

Notes:

- When [HDMI] option is set to [PCM Multi-CH], the audio may output as PCM Stereo if the PCM Multi-Ch information is not detected from HDMI device with EDID.
- When [HDMI] and [SPDIF] options are set to [DTS Re-Encode], the DTS audio will output on BD-ROM disc, and the original audio will output on the other discs (like [Primary Pass-Thru]).

Sampling Freq. (Maximum Sampling Frequency)

[192KHz] – Select this if your A/V Receiver or Amplifier is capable of handling 192 KHz signals.

[96KHz] – Select this if your A/V Receiver or Amplifier is NOT capable of handling 192 KHz signals. When this choice is made, this unit automatically converts any 192 KHz signals to 96 KHz so your system can decode them.

[48KHz] – Select this if your A/V Receiver or Amplifier is NOT capable of handling 192 KHz and 96 KHz signal. When this choice is made, this unit automatically converts any 192 KHz and 96 KHz signals to 48 KHz so your system can decode them.

Check the documentation for your A/V Receiver or Amplifier to verify its capabilities.

DRC (Dynamic Range Control)

During the disc encoded in Dolby Digital or Dolby Digital Plus is playing back, you may wish to compress the dynamic range of the audio output (the difference between the loudest sounds and the quietest ones). This allows you to listen to a movie at a lower volume without losing clarity of sound. Set DRC to [On] for this effect.

Note:

The DRC setting can be changed only when a disc is not inserted or the unit is in complete stop mode.

[LOCK] Menu (Parental Control)

The [LOCK] settings affect only Netflix movie, BD and DVD playback.



Password

You can enter or change the password.

1. Select [Password] option on the [LOCK] menu then press ►.
2. To create new password, press ENTER when the [New] option is highlighted. Input new password and press ENTER. Enter it again and press ENTER to verify.

To change the password, press ENTER when the [Change] option is highlighted, then input old password and press ENTER. Input new password and press ENTER. Enter it again and press ENTER to verify.

To delete the password, select [Delete] option then press ENTER, then input old password and press ENTER. The password is deleted.

Tip:

If you make a mistake before pressing ENTER, press CLEAR. Then input the correct password.

If you forget your password

If you forget your password, you can clear it using the following steps:

1. Remove any disc that might be in the player.
2. Select [Password] option.
3. Use Number buttons to enter the 6-digit number "210499".
The "PIN CLEAR" appears in the display window and the password is deleted.

Rating

Blocks playback of rated disc based on their content. (Not all discs are rated.)

1. Select [Rating] on the [LOCK] menu then press ►.
2. To access this option, you must input the password you have created. If you have not yet entered password, you will be prompted to do so. Input a password and press ENTER. Enter it again and press ENTER to verify. If you make a mistake before pressing ENTER, press CLEAR.
3. Select a rating from 1 to 8 using the ▲ / ▼ buttons.

[Rating 1-8] – Rating one (1) has the most restrictions and rating eight (8) is the least restrictive.

[Unlock] – If you select unlock, parental control is not active and the disc plays in full.

4. Press ENTER to confirm your rating selection.

BD Age

Set an age limit of BD-ROM play.

1. Select [BD Age] on the [LOCK] menu then press ►.
2. Follow step 2 as shown above (Rating).
3. Use number buttons to input an age limit for BD-ROM viewing.

[255] – All BD-ROM can be played.

[0-254] – Prohibits play of BD-ROM with corresponding ratings recorded on them.

4. Press ENTER to confirm your selection.

Area Code

Enter the code of the area whose standards were used to rate the DVD video disc, based on the list on page 37.

1. Select [Area Code] on the [LOCK] menu then press ►.
2. Follow step 2 as shown above (Rating).
3. Select the first character using ▲ / ▼ buttons then press ENTER.
4. Select the second character using ▲ / ▼ buttons then press ENTER to confirm your selection.

[NETWORK] Menu

The [NETWORK] settings are needed to use the BD Live and Netflix feature.

Some BD-ROM discs may enable you to access special BD-ROM sites, if you connect the player to the Internet. For example, if an BD-ROM site includes content such as links to future movie trailers, you can watch the downloaded on-line content on the player.

You do not need to connect to a PC to use this function.

Preparations:

- This feature requires an always-on broadband internet connection. (see page 16.)
- An BD-ROM disc compatible with this feature is required. Not all BD-ROM discs are compatible.



IP Mode

If there is a DHCP server on the local area network (LAN), this player will automatically be allocated an IP address. If you're using a broadband router or broadband modem that has a DHCP (Dynamic Host Configuration Protocol) server function, select [Dynamic IP]. The IP address will automatically be determined.

If there is no DHCP server on the network and you want to set the IP address manually, select [Static IP] then set the [IP Address], [Subnet Mask], [Gateway] and [DNS Server] using [IP Setting] option.

Note:

The [IP Mode] menu shows if the internet is connected or not. "Ø" will appear when connection is failed.

IP Setting

This option is available only if [IP Mode] option is set to [Static IP].

Use the ▲ / ▼ / ◀ / ▶ buttons to select a field; use the number buttons to enter a value. Press ENTER when [OK] is highlighted to finish and exit the screen.

BD-LIVE connection

You can restrict Internet access when BD-Live functions are used.

[Permitted] Internet access is permitted for all BD-Live contents.

[Partially permitted] Internet access is permitted only for BD-Live contents which have content owner certificates. Internet access and AACs Online functions are prohibited for all BD-Live contents without a certificate.

[Prohibited] Internet access is prohibited for all BD-Live contents.

[OTHERS] Menu



Skin

Changes the background of the initial screen.

Java Font Size **BD**

You can adjust the default text size displayed for the BD-J contents during BD-ROM playback.

This setting is only valid when BD-J contents do not set the size of text.

Please select a font size bigger than 24 when the player is connected with an HD TV.

Initialize

You can reset the player to its original factory settings, initialize the BD storage or deactivate the player.

1. Select [Initialize] option then press ►.
2. Press ▲ / ▼ to select the desired option then press ENTER.
The confirm message will appear.
[Factory Set] – If you need to, you can reset the player to all its factory settings. Some options cannot be reset. (Rating, Password and Area Code, etc.)
[BD Storage Clear] – Initializes the BD contents from the connected USB device.
[Deactivate Netflix] – Deactivates your player. To activate the Netflix again, see page 32.
3. Use ◀ / ▶ to select [Yes] or [No] then press ENTER.

Note:

If you reset the player to its original factory settings using [Factory Set] option, Netflix is deactivated also. To activate the Netflix again, see page 32.

Software Update

You can update the software by connecting the unit directly to the software update server (see page 41).

Netflix ESN

We provide you the Netflix ESN (Electronic Serial Number) that allows you to rent and purchase videos using the Netflix website.

For more information, please visit:

www.netflix.com

Select [Netflix ESN] option and the serial number will appear.

Operations

General disc playback features

1. Load your chosen disc in the tray, with the playback side down.
2. Start playback using the HOME menu (see page 9).

Buttons	Operations	Discs
OPEN / CLOSE (▲)	Opens or closes the disc tray.	All Discs
■ (STOP)	<p>Stops the playback.</p> <p>The unit records the stopped point, depending on the disc. "■" appears on the screen briefly. Press ► (PLAY) to resume playback (from the scene point). If you press STOP (■) again or unload the disc ("■" appears on the screen.), the unit will clear the stopped point. (■ = Resume Stop, ■ = Complete Stop)</p> <p>Notes:</p> <ul style="list-style-type: none"> • The resume point may be cleared when a button is pressed (for example; POWER, OPEN/CLOSE, etc). • On BD-Video discs including BD-J, the resume play function does not work. • On BD-ROM interactive title, the unit will be in Complete Stop mode if you press STOP once during playback. 	<p>All Discs</p> <p>BD DVD ACD MP3 WMA AVCHD</p>
(PAUSE)	<p>During playback, press to pause playback.</p> <p>Tip: During Audio CD or MP3/WMA playback, press once again to resume playback.</p> <p>Press repeatedly to play Frame-by-Frame.</p>	<p>All Discs</p> <p>DVD BD AVCHD</p>
◀◀ / ▶▶ (SKIP)	<p>During playback, press ◀◀ or ▶▶ to go to the next chapter/track/file or to return to the beginning of the current chapter/track/file.</p> <p>Press ◀◀ twice briefly to step back to the previous chapter/track/file.</p>	All Discs
◀◀ / ▶▶ (SCAN)	<p>During playback, press SCAN (◀◀ or ▶▶) repeatedly to select the required scan speed.</p> <ul style="list-style-type: none"> - DVD, BD, AVCHD: 5 steps, - Audio CD, MP3, WMA: 3 steps <p>While the playback is paused, press SCAN ▶▶ repeatedly to play in slow motion (4 steps, forward only).</p>	<p>All Discs</p> <p>DVD BD AVCHD</p>
REPEAT	<p>During playback, press REPEAT repeatedly to select a desired repeat mode.</p> <p>DVD, BD, AVCHD: Chapter/Title/Off Audio CD, MP3, WMA: Track/All/Off</p> <p>Note: If you press ▶▶ once during Repeat Chapter/Track playback, the repeat playback cancels.</p>	<p>DVD BD ACD MP3 WMA AVCHD</p>
A-B	<p>During playback, each press of A-B button to select point A and point B and repeats a sequence from point A (Starting point) to point B (End point). To cancel the sequence, press A-B.</p>	<p>DVD BD ACD AVCHD</p>

Continued →

General disc playback features (Continued)

Buttons	Operations	Discs
TITLE/POP UP	If the current DVD or BD-ROM disc has a menu, the Title menu or Popup menu appears on the screen. Depending on the disc, the menu may not be available.	DVD BD AVCHD
DISC MENU	The menu appears on the screen. Depending on the disc, the menu may not be available.	DVD BD AVCHD
ANGLE (⌂)	During playback of the disc contains scenes recorded at different camera angles, press ANGLE repeatedly to select a desired angle. Note: When you are playing a disc containing scenes recorded at different camera angles, the angle indicator will appear on the TV screen for a while and display window during scenes recorded at different angles as an indication that angle switching is possible.	DVD BD
SUBTITLE (☒)	During playback, press SUBTITLE repeatedly to select a desired subtitle language. Note: Some discs allow you to change subtitle selections only via the disc menu. If this is the case, press TITLE/POPUP or DISC MENU button and choose the appropriate subtitle from the selections on the disc menu.	DVD BD AVCHD
SUBTITLE ON/OFF	During playback, press SUBTITLE ON/OFF to switch the subtitle on or off.	DVD BD AVCHD
AUDIO (⌂)	During playback, press AUDIO repeatedly to hear a different audio language or audio track. Notes: <ul style="list-style-type: none"> Some discs allow you to change audio selections only via the disc menu. If this is the case, press TITLE/POPUP or DISC MENU button and choose the appropriate audio from the selections on the disc menu. Immediately after you have switched sound, there may be a temporary discrepancy between the display and actual sound. On BD-ROM disc, the multi audio format (5.1CH or 7.1CH) is displayed with [MultiCH] in the on-screen display. 	DVD BD AVCHD

Notes on general features:

- When you turn on the player or replace a disc, the player returns to the initial default setting. Depending on a disc, a specific type of audio the disc has is output.
- Depending on the pre-recorded contents of the BD-ROM, some functions may not be available or may be operated differently than other media.

If a disc menu screen is displayed

DVD **BD** **AVCHD**

The menu screen may be displayed first after loading a disc which contains a menu.

Use ◀ / ▶ / ▲ / ▼ buttons to select the title/chapter you want to view, then press ENTER to start playback.

Enlarge the playback image

DVD **BD** **AVCHD**

1. During playback or pause mode, press ZOOM to display the [ZOOM] menu.
2. Use ◀ / ▶ to select zoom mode (16 steps). Press RETURN to disappear the menu.
3. To return to the normal picture size, select [Off] on the [ZOOM] menu.

Note:

This function may not work on some disc or titles.

Time Search **DVD** **BD** **AVCHD**

To start playing at any chosen time on the disc:

1. Press DISPLAY during playback.
2. Press ▲ / ▼ to select the time clock icon and "--:--:--" appears.
3. Input the required start time in hours, minutes, and seconds from left to right. For example, to find a scene at 2 hours, 10 minutes, and 20 seconds, enter "21020" and press ENTER. If you enter the wrong numbers, press CLEAR to remove the numbers you entered. Then input the correct numbers.
4. Press ENTER to confirm. Playback starts from the selected time.

Note:

This function may not work on some disc or titles.

Skip Search **DVD** **BD** **AVCHD**

You can skip the playback 15 seconds forward or backward using the search menu.

1. During playback, press SEARCH and the search menu appears on the screen.
2. Press ◀ / ▶ to skip the playback forward or backward.

Tip:

You can select a point that you want to skip by pressing and holding ◀ / ▶ button.

Marker Search **DVD** **BD** **AVCHD**

To enter a Marker

You can start playback from up to nine memorized points. To enter a marker, press MARKER at the desired point on the disc. The Marker icon appears on the TV screen briefly. Repeat to enter up to nine markers.

To Recall or Clear a Marked Scene

1. Press SEARCH and the search menu appears on the screen.
2. Press a number button to select a marker number that you want to recall. Playback starts from the marked scene.

OR

Press ▼ to highlight a marker number. Use ◀ / ▶ to select a marked scene that you want to recall or clear.

Press ENTER and playback starts from the marked scene. Press CLEAR and the marked scene is erased from the search menu.

Notes:

- This function may not work on some disc or titles.
- All marked points are cleared if you press STOP (■) twice (complete stop), the title is changed or unload the disc.

Using Color (A, B, C, D) Buttons **BD**

These buttons are available only during BD-J contents playback. Use the appropriate buttons as indicated by the display. Depending on the disc contents, the functions of each button may differ.

Last Scene Memory **DVD** **BD**

This unit memorizes last scene from the last disc that is viewed. The last scene remains in memory even if you remove the disc from the unit or switch off the unit. If you load a disc that has the scene memorized, the scene is automatically recalled.

Notes:

- Settings are stored in memory for use any time.
- This unit does not memorize settings of a disc if you switch off the unit before commencing to play it.
- Last Scene Memory function for a previous disc is erased once a different disc is played.
- This function may not work depending on the disc.

Screen Saver

The screen saver appears when you leave the player in Stop mode for about five minutes.

Displaying Disc Information On-Screen

DVD **BD** **AVCHD**

You can display various information about the disc loaded on-screen.

1. Press DISPLAY to show various playback information.
The items displayed differ depending on the disc type or playing status.



2. During BD-ROM or DVD playback, you can select an item by pressing ▲ / ▼ and change or select the setting by pressing ◀ / ▶.
 - Title – Current title number/total number of titles.
 - Chapter – Current chapter number/total number of chapters.
 - Time – Elapsed playing time.
 - Audio – Selected audio language or channel.
 - Subtitle – Selected subtitle.
 - Angle – Selected angle/total number of angles.

Notes:

- If no button is pressed for a few seconds, the on-screen display disappears.
- A title number cannot be selected on some discs.
- An item may not be available on some discs or titles.
- If BD interactive title is playing back, some setting information is displayed on the screen but prohibited to be changed.

Enjoying BD-LIVE™ or BONUS VIEW™ in BD-Video **BD**

This unit allows you to enjoy functions such as picture-in-picture, secondary audio and Virtual packages, etc., with BD-Video supporting BONUSVIEW (BD-ROM version 2 Profile 1 version 1.1/ Final Standard Profile). In addition to the BONUSVIEW function, BD-Video supporting BD-Live (BD-ROM version 2 Profile 2) that has a network extension function allows you to enjoy more functions such as online games by connecting this unit to the Internet.

Playing secondary video (picture-in-picture) and secondary audio

Secondary video can be played from a disc compatible with the picture-in-picture function.

For the playback method, refer to the instructions for the disc.

- To turn on/off secondary video, press PIP. Secondary video is played. Press the button to turn it ON and OFF.
- To turn on/off audio with the secondary video, press PIP AUDIO. The secondary audio is played. Press the button to turn it ON and OFF.

Notes:

- Discs may not always be played back according to the settings on this unit, as certain playback formats are prioritized on certain discs.
- Only the primary video is played during search/slow-motion or frame-by-frame.
- When the secondary video is turned off, the secondary audio does not play.
- This function may not work depending on the disc.

Enjoying BD-Live discs with Internet

Preparations:

- The unit must be connected to the Internet and set up to use the BD-Live functions (see page 16 and 22).
- An USB device is required to use this function. Connect an USB device (see page 9).
- The free space in the USB device must be more than 1GB.

This unit supports BD-Live, a new BD-Video function that allows you to use the following interactive functions when connected to the Internet. (The usable functions and the operating method may vary with each disc. For details, refer to the instructions for the disc.)

- Additional contents such as movie's trailer, subtitles and BD-J, etc. can be downloaded to USB device to play them.
- Special video data, etc. may be played back while they are being downloaded to an USB device.

Caution:

Do not extract the connected USB device while content is being downloaded or a Blu-ray disc is still in the disc tray. Doing so may damage the connected USB device and BD-Live features may not operate properly with the damaged USB device anymore. If the connected USB device seems damaged from such an action, you can format the connected USB device from the PC and reuse it with BD300.

AACS Online

When discs supporting BD-Live are played back, the player or disc IDs may be sent to the content provider via the Internet.

Services and functions to be provided differ depending on the disc.

- You can be introduced to other similar movies if you record your viewing history on the server by using these IDs.
- Game score histories can be saved.

Notes:

- **It may take up to several minutes to load and start enjoying BD-Live contents.**
- **Depending on a disc, the BD-Live function may not be operated if [BD-LIVE connection] option is set to [Partially Permitted]. (See page 22.)**
- **The connection to the Internet may take time or the Internet may not be connected depending on the connection environment. It is required that you use a broadband connection.**
- **Do not remove the USB device during operation. The USB device may be damaged. Stop playback and turn off the menu beforehand.**

Tip:

Special video data, etc. may be played back while they are being downloaded to an USB device using one function of BD-Live. The playback may be paused depending on the communication environment.

Some functions may be disabled to prevent skipping to sections that have not been downloaded, etc.

Playing a DVD VR Format Disc

This unit will play DVD-RW disc that is recorded using the Video Recording (VR) format.

1. Insert a disc and close the tray.
The [MOVIE] menu appears on the TV screen



2. Press ▲ / ▼ to select a title then press ► (PLAY) and playback starts.
You can use variable playback functions.
Refer to pages 24-27.
3. Press DISC MENU to move to the list menu.

Notes:

- On the [MOVIE] menu, use red or blue color button to move to the previous or next page.
- Unfinalized DVD-VR format discs may not be played in this player.
- Some DVD-VR disc are made with CPRM data by DVD RECORDER. This unit cannot support these kinds of discs.

What is CPRM?

CPRM is a copy protection system (with scramble system) only allowing the recording of 'copy once' broadcast programs. CPRM stands for Content Protection for Recordable Media.

MOVIE menu options

1. Use ▲ / ▼ to select a title on the [MOVIE] menu then press ENTER.
The menu options appear.
2. Use ▲ / ▼ to select an option, then press ENTER.

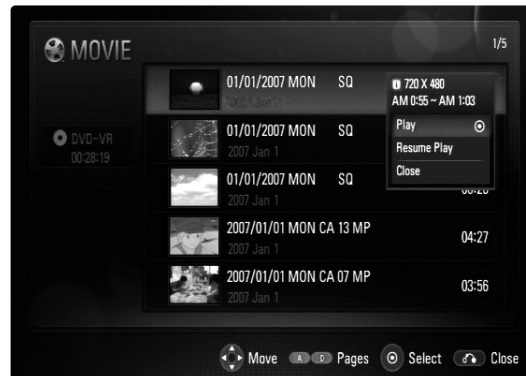

- **[Play]** Starts playback the selected title.
- **[Resume Play]** Starts playback from where you stopped it previously.
- **[Close]** Exits menu options. Also you can disappear it by pressing RETURN button.

Playing an Audio CD or MP3/WMA files **ACD** **MP3** **WMA**

The player can play Audio CDs and MP3/WMA files. Before playing MP3/WMA files, read "MP3/WMA audio file requirement" on right.

1. Insert Audio CD or a disc containing MP3/WMA files, or connect the USB Device containing MP3/WMA files
2. Press HOME and Home Menu appears.
3. Select [Music] then press ENTER. The MUSIC menu appears on the TV screen.

Note:

When the USB Device is connected and a disc is inserted simultaneously, the menu for selecting a media will appear. Select a media then press ENTER.

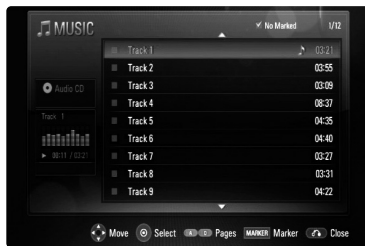

Example) Audio CD

4. Use ▲/▼ to select a track or file then press ► (PLAY). Playback starts. You can use variable playback functions. Refer to page 24.
5. To stop playback at any time, press STOP (■).

Tips:

- To go directly to any track or file and play, enter the track/file number using the numbered buttons (0-9).
- The playback may start automatically if the Audio CD inserted.
- Select a folder then press ENTER and you can view the files in the folder. If you want to move to the upper directory, use ◀ or ▲/▼ to highlight [UP Folder] and press ENTER.
- On the MUSIC menu, use red or blue color button to move to the previous or next page.
- The equalizer indicator is not coupled with the music in play back.
- If there is impossible code to express in the file name, it may be displayed as illegible.

MUSIC menu options

1. Use ▲ / ▼ to select a track or file on the MUSIC menu then press ENTER. The menu options appear.
2. Use ▲ / ▼ to select an option, then press ENTER.



- **[Play]** Starts playback the selected track or file.
- **[Select Play]** Plays back only the marked track(s) or file(s). Use MARKER for selecting the multiple files or tracks.
- **[Random]** Starts or stops random playback. By pressing ► during random playback, the unit selects another track and resumes random playback.
- **[Unmark All]** Unmarks all marked files or tracks.
- **[Close]** Exits menu options. Also you can disappear it by pressing RETURN button.

Note:

You cannot use [Select Play] and [Random] functions simultaneously.

MP3/WMA audio file requirement

File extensions: ".mp3", ".wma"

Sampling frequency: 8 - 48 kHz

Bit rate: 8 - 320kbps

CD-R/RW, DVD±R/RW, BD-R/RE Format: ISO 9660+JOLIET, UDF and UDF Bridge format

Maximum Files/Disc: Less than 1999 (total number of files and folders)

Notes on MP3/WMA file

- Depending on the size and number of the MP3/WMA files, it may take several minutes to read the contents of the media.
- This unit cannot support the ID3 Tag embedded in the MP3 file.

Viewing a Photo file **PHOTO**

This unit can play a photo files. Before playing photo recordings, read "Photo file requirement" on below.

1. Insert a disc containing photo files, or connect the USB Device containing photo files.
2. Press HOME and Home Menu appears.
3. Select [Photo] then press ENTER.
The PHOTO menu appears on the TV screen.

Note:

When the USB Device is connected and a disc is inserted simultaneously, the menu for selecting a media will appear. Select a media then press ENTER.



4. Use ▲▼◀▶ to select a file and press ENTER.
The selected image is displayed in full screen.



5. To stop viewing at any time, press STOP (■).
The PHOTO menu appears.

Tips:

- To go directly to any file and play, enter the file number using the numbered buttons (0-9).
- You can advance to the previous or next file by pressing ◀◀ or ▶▶ during viewing a photo file in full screen.
- You can start the slide show by pressing ▶ (PLAY) while the PHOTO menu appears.
- Select a folder then press ENTER and you can view the files in the folder. If you want to move to the upper directory, use ▲/▼/◀/▶ to highlight [UP Folder] and press ENTER.
- On the PHOTO menu, use red or blue color button to move to the previous or next page.
- If there is impossible code to express in the file name, it may be displayed as illegible.

Options during viewing a photo file in full screen

1. Follow steps 1-4 as shown left (Viewing a Photo file).
2. You can use variable options during viewing a picture.
3. Use ▲▼◀▶ to select an option.

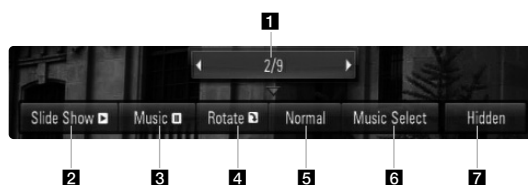

- 1 Use ◀/▶ to advance to the previous or next file.
- 2 Use ENTER to start or pause the slide show.
- 3 Use ENTER to play or pause the background music. This option is available after the background music is selected using [Music Select] option.
- 4 Use ENTER to rotate the picture clockwise. This option is not available during slide show.
- 5 Use ENTER to set the Slide Show speed.
- 6 Selects the background music.
 - 1) Press ENTER and the menu will appear.
 - 2) Use ▲▼◀▶ to select a media or folder that there are music file(s).
 - 3) Press ENTER to confirm your selection.
- 7 Press ENTER to exit the option menu. To appear the menu again, press ENTER.

Photo file requirement

File extensions: ".jpg", ".jpeg", ".png"

Recommended size:

Less than 3,000 x 3,000 x 24 bit/pixel

Less than 3,000 x 2,250 x 32 bit/pixel

CD-R/RW, DVD±R/RW, BD-R/RE Format:

ISO 9660+JOLIET, UDF and UDF Bridge format

Maximum Files/Disc:

Less than 1999 (total number of files and folders)

Notes on Photo file

- Progressive and lossless compression photo image files are not supported.
- Depending on the size and number of the photo files, it may take several minutes to read the contents of the media.

Netflix Operation

You can instantly watch movies (very few new releases) & TV episodes from Netflix streamed over the internet to your TV via your LG BD300.

To become a Netflix member visit:

www.netflix.com/LG

Preparations:

Step 1: Check the Network Connection

See page 16.

Step 2: Configuring Network Settings

See page 22.

Step 3: Checking Network Configuration

1. Select [NETWORK] on the [Setup] menu.
2. Select [IP Mode] option on the [NETWORK] menu.
3. Check the Network status indicator shown above the menu. (The Network status indicator changes according to Network configuration.)



Able to use network



Testing Network



Unable to use network

Note:

If newer software is needed, a software update screen will automatically appear when you select [Streaming] from the home menu. For details on software updates, see page 41.

Getting Help

For questions regarding the Netflix service please visit:

www.netflix.com/LG/help

or call 1-866-579-7113

For questions regarding your player please visit:

www.us.lgservice.com

or call 1-800-243-0000

Activating your player

Activating your player establishes a connection between your player and your Netflix account. You must activate your player before you can use it to watch movies streamed over the INTERNET from Netflix.

1. Press HOME and the home menu will appear.
2. Use ◀ / ▶ to select the [Streaming] then press ENTER.

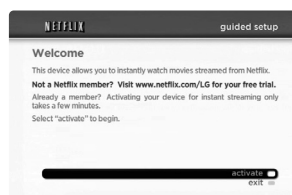

3. Use ▲ / ▼ to select the [activate] then press ENTER. Wait for the activation screen to appear on your TV screen. You are now ready to complete activation on the Netflix website.



4. On your computer, visit www.netflix.com/activate
5. If necessary, enter your [Sign in Name] and [Password] to log into your account.
6. Enter the activation code that appears on your TV screen.



7. When the "Congratulations" screen appears on your TV, you're ready to add movies to your instant Queue. See "Filling your instant Queue" for instruction.

Note:

You can deactivate streaming from Netflix to your player using [Deactivate Netflix] option on the setup menu (see page 23).

Using your player for Netflix

After you activate your player, you're ready to add movies & TV episodes to your instant Queue. You can then use your player's remote to browse your instant Queue and to select and watch titles on your TV. You will be amazed at how quick and easy it is.

Filling your instant Queue

Your instant Queue works just like your DVD Queue. Add and manage the movies & TV episodes in your instant Queue from the Netflix website on your computer. Your instant Queue also appears on your TV via your player, so your selections are available to watch anytime.

1. Visit the Netflix website on your computer:
www.netflix.com
2. If necessary, enter your Sign in Name and Password to log into your account.



3. Click [Watch Instantly] tab.



4. When you find a movie or TV episode you want to watch, mouse over the [Add/Play] button to reveal additional options, and then click [Add to instant Queue].



5. Repeat step 4 to add more movies & TV episodes to your instant Queue.
6. (Optional) Arrange your instant Queue by clicking the [Instant] subtab.
 - To rearrange your instant Queue, drag and drop the titles in the order you want them, or change the numbers to the left of the titles and then click [Update Instant Queue] to your changes.

- To remove a title from your instant Queue, click the [Remove] check box to the right of the title and then click [Update Instant Queue] to your changes.

Selecting a movie to watch on your TV

After you set up your player and add movies & TV episodes, you can browse and watch them on your TV.

1. Press HOME and the home menu will appear.
2. Use ◀ / ▶ to select the [Streaming] then press ENTER.

The instant Queue screen will appear.



3. Use ◀ / ▶ to highlight a movie on your instant Queue. Use ◀◀ / ▶▶ button to move to the previous or next page. The selected movie shows the title, rating and total time.

4. Do either of the following:

- Press ▶ (PLAY) to play back the highlighted title.
- Press ENTER to view details for the highlighted title, and then use ▲ / ▼ to choose any of the menu items:
[play] Starts playing the selected title.

[resume playing] Plays a previously paused title from the scene where you paused it. This option is available only if you begin watching a title and then pause it.

[play from beginning] Starts playing from the beginning of the selected title.

[choose a different episode] (TV series only) Enables you to select a specific show of a TV series. Press ◀ / ▶ to highlight the show you want to view, and then press ENTER to choose it.

[rate] Enables you to rate a movie or show. The more stars, the higher the rating. Press ENTER to access the rating feature, and then press ◀ / ▶ to increase or decrease the rating. Press ENTER again to confirm the selected rating.

[remove] Deletes the selected movie from your instant Queue.

[remove series] (TV series only) Deletes the selected TV series from your instant Queue.

5. Press ▲ to return to your instant Queue.

Playing a movie

While watching a movie or TV episode from Netflix via your player, you have full control over your viewing experience. You can use the buttons on the remote to pause and resume viewing and to scan forward and backward, just like when you watch a DVD. While playing a movie, the buttons on the remote do the following:

Button(s)	Operations
▶	Starts playing back the movie.
⏸	To pause a movie while it's playing. To resume playing a paused movie, press ▶ (Play) again.
■ / ▲	Stops the movie and displays your instant Queue.
ENTER	Pauses playing the movie and enters frame scanning mode.
▶	Pauses playing the movie and enters frame scanning mode. To scan forward one frame at a time, press the button again.
◀	Pauses playing the movie and enters frame scanning mode. To scan backward one frame at a time, press the button again.
▶▶ / ◀◀	Pauses playing the movie and scans forward or backward through the movie. To scan faster, press the button again. To play the highlighted scene, press ENTER or ▶. To resume playing from the point you paused the movie, press ▲.
HOME	When you have finished watching movies streamed from Netflix, simply press the HOME button on the remote control to go to the Home Menu.

Note:

Even if you use a high-resolution setup, audio/video quality may be compromised based on the speed of your broadband internet connection.

Your Internet Service Provider (ISP) determines your broadband speed. We recommend a minimum connection speed of 1.5 Mbps. For the best quality picture, a connection speed of 4.0 Mbps is required. Sometimes your broadband speed varies based on your ISP's network conditions. Contact your ISP if you have problems maintaining a fast connection that is reliable, or if you want to increase your connection speed. Many ISPs offer a variety of broadband speed options.

Reference

Controlling a TV with the Supplied Universal Remote Control

You can control the volume, input source, and power state of your TV with the supplied Universal Remote Control.

If your TV is listed in the table on page 36, set the appropriate manufacturer code. Follow steps 1-2 as shown right.

You can control your TV using the buttons below.

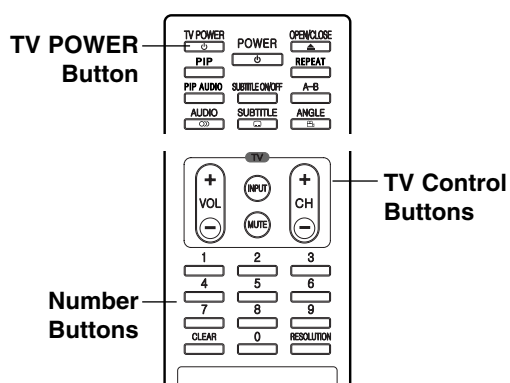

By pressing	You can
TV POWER	Turn the TV on or off.
INPUT	Switch the TV's input source between the TV and other input sources.
CH +/-	Scan up or down through memorized channels.
VOL +/-	Adjust the volume of the TV.
MUTE	Temporarily turns TV sound OFF, press again to restore.

Note:

Depending on the unit being connected, you may not be able to control your TV using some of the buttons.

To program the remote to control the TV using the manufacturer code

If your TV is listed in the table on the next page, set the appropriate manufacturer code.

- While holding down TV POWER button, press the number buttons to select the manufacturer code for your TV (Refer to table on the next page).
 - If more than one code number is listed, try entering them one at a time until you find the one that works with your TV.
- Release TV POWER button.

Notes:

- Depending on your TV, some or all buttons may not function on the TV, even after entering the correct manufacturer code.
- If you enter a new code number, the code number previously entered will be erased.
- When you replace the batteries of the remote, the code number you have set may be reset to the default setting. Set the appropriate code number again.

Code numbers of controllable TVs

Manufacturer	Code Number
A MARK	112 143
ADMIRAL	072 081 161
AKAI	006 146
AMPRO	073 167
AMSTRAD	052
ANAM	026 043 054 056 080 104 108 112 115 118 121 131
AOC	004 006 058 112
BLAUPUNKT	088
CANDLE	002 003 004 006
CAPEHART	058
CETRONIC	043
CITIZEN	002 003 004 006 043 101 103 143
CLASSIC	043
CONCERTO	004
CONTEC	039 043 050 051
CORONADO	143
CRAIG	043 054
CROWN	043 143
CURTIS MATHES	004 006 101 116 143
CXC	043
DAEWOO	004 016 017 043 044 055 071 076 103 107 111 114 117 120 123 125 127 128 136 143
DAYTRON	004 116 143
DYNASTY	043
DYNATECH	062
ELECTROHOME	024 077 143
EMERSON	004 005 006 028 043 047 048 050 051 096 116 143 151 153 154 155
FISHER	007 057
FUNAI	028 043
FUTURETECH	043
GE	004 006 008 009 034 056 073 074 091 116 130 144 155 160 161 165
HALL MARK	004 116
HITACHI	004 006 009 010 011 012 023 041 075 143 158 163 166 187
INFINITY	164
INKEL	129
JBL	164
JCPENNY	004 006 008 009 024 030 065 101 143 156 160
JENSEN	013
JVC	034 038 070 083 145

Manufacturer	Code Number
KEC	043
KENWOOD	006 070
KLOSS	002 059
KMC	143
KTV	006 043 143 154
LG	001(Default) 004 102 106 110 112 113 116 119 122 127 137 143
LODGENET	072
LOGIK	072
LUXMAN	004
LXI	007 015 052 081 160 164 166
MAGNAVOX	003 004 006 022 059 060 061 063 064 127 143 160 164
MARANTZ	006 077 164
MATSUI	164
MEMOREX	004 007 072 116
METZ	088
MGA	004 006 024 028 042 049 077 116
MINERVA	088
MITSUBISHI	004 006 024 028 040 042 109 116 124 146
MTC	004 006 062 101
NAD	015 025
NEC	006 007 016 019 024 040 056 130 132 134
NIKEI	043
ONKING	043
ONWA	043
OPTONICA	019 081
PADIO SHACK	004
PANASONIC	034 056 080 092 164
PHILCO	003 004 006 024 043 056 059 060 063 064 127 143 164
PHILIPS	003 004 005 006 038 059 070 093 143 160 164
PIONEER	006 018 023 025 027 116 135 176
PORTLAND	004 143
PROSCAN	144 160 161 165 167
PROTON	004 058 116 131 143 171 173
QUASAR	034 056 092
RADIO SHACK	019 043 047 116 127 143
RCA	004 006 023 024 056 065 074 144 152 156 160 161 165

Manufacturer	Code Number
REALISTIC	007 019 043 047
ROCTEC	186
RUNCO	168 169
SAMPO	004 006 058 116
SAMSUNG	004 050 089 101 105 113 116 127 133 137 143 160
SANYO	007 020 021 033 039 053 057 082 166
SCOTT	004 028 043 048 116 143
SEARS	004 007 015 028 030 057 082 094 101 116 143 160
SHARP	004 014 019 022 028 029 081 143 170 175
SIEMENS	088
SIGNATURE	072
SONY	041 070 079 085 126 139 147 185
SOUNDESIGN	003 004 028 043 116
SPECTRICON	112
SSS	004 043
SUPRE MACY	002
SYLVANIA	003 004 006 044 059 060 063 064 116 127 140 160 164
TANDY	081
TATUNG	056 062
TECHNICS	034 080 084
TECHWOOD	004
TEKNIKA	002 003 004 006 024 028 031 043 072 077 101 103 143
TELEFUNKEN	037 046 086 087
TELERENT	072
TERA	172
TMK	004 116
TOSHIBA	007 015 030 040 051 062 101 138
TOTEVISION	143
UNIVERSAL	008 009
VIDEO CONCEPTS	146
VIDIKRON	174
VIDTECH	004 116
WARDS	004 008 009 019 028 060 061 063 064 072 074 116 143 164
YAMAHA	004 006
YORK	004 116
YUPITERU	043
ZENITH	001 072 073 095 103 157
ZONDA	112

Language Codes

Use this list to input your desired language for the following initial settings:
Disc Audio, Disc Subtitle, Disc Menu.

Language	Code	Language	Code	Language	Code	Language	Code
Abkhazian	6566	Fiji	7074	Lingala	7678	Singhalese	8373
Afar	6565	Finnish	7073	Lithuanian	7684	Slovak	8375
Afrikaans	6570	French	7082	Macedonian	7775	Slovenian	8376
Albanian	8381	Frisian	7089	Malagasy	7771	Somali	8379
Ameharic	6577	Galician	7176	Malay	7783	Spanish	6983
Arabic	6582	Georgian	7565	Malayalam	7776	Sudanese	8385
Armenian	7289	German	6869	Maltese	7784	Swahili	8387
Assamese	6583	Greek	6976	Maori	7773	Swedish	8386
Aymara	6589	Greenlandic	7576	Marathi	7782	Tagalog	8476
Azerbaijani	6590	Guarani	7178	Moldavian	7779	Tajik	8471
Bashkir	6665	Gujarati	7185	Mongolian	7778	Tamil	8465
Basque	6985	Hausa	7265	Nauru	7865	Tatar	8484
Bengali; Bangla	6678	Hebrew	7387	Nepali	7869	Telugu	8469
Bhutani	6890	Hindi	7273	Norwegian	7879	Thai	8472
Bihari	6672	Hungarian	7285	Oriya	7982	Tibetan	6679
Breton	6682	Icelandic	7383	Panjabi	8065	Tigrinya	8473
Bulgarian	6671	Indonesian	7378	Pashto, Pushto	8083	Tonga	8479
Burmese	7789	Interlingua	7365	Persian	7065	Turkish	8482
Byelorussian	6669	Irish	7165	Polish	8076	Turkmen	8475
Cambodian	7577	Italian	7384	Portuguese	8084	Twi	8487
Catalan	6765	Japanese	7465	Quechua	8185	Ukrainian	8575
Chinese	9072	Javanese	7487	Rhaeto-Romance	8277	Urdu	8582
Corsican	6779	Kannada	7578	Rumanian	8279	Uzbek	8590
Croatian	7282	Kashmiri	7583	Russian	8285	Vietnamese	8673
Czech	6783	Kazakh	7575	Samoan	8377	Volapük	8679
Danish	6865	Kirghiz	7589	Sanskrit	8365	Welsh	6789
Dutch	7876	Korean	7579	Scots Gaelic	7168	Wolof	8779
English	6978	Kurdish	7585	Serbian	8382	Xhosa	8872
Esperanto	6979	Laothian	7679	Serbo-Croatian	8372	Yiddish	7473
Estonian	6984	Latin	7665	Shona	8378	Yoruba	8979
Faroese	7079	Latvian, Lettish	7686	Sindhi	8368	Zulu	9085

Area Codes

Choose an Area code from this list.

Area	Code	Area	Code	Area	Code	Area	Code
Afghanistan	AF	Ethiopia	ET	Malaysia	MY	Saudi Arabia	SA
Argentina	AR	Fiji	FJ	Maldives	MV	Senegal	SN
Australia	AU	Finland	FI	Mexico	MX	Singapore	SG
Austria	AT	France	FR	Monaco	MC	Slovak Republic	SK
Belgium	BE	Germany	DE	Mongolia	MN	Slovenia	SI
Bhutan	BT	Great Britain	GB	Morocco	MA	South Africa	ZA
Bolivia	BO	Greece	GR	Nepal	NP	South Korea	KR
Brazil	BR	Greenland	GL	Netherlands	NL	Spain	ES
Cambodia	KH	Herd and McDonald Islands	HM	Netherlands Antilles	AN	Sri Lanka	LK
Canada	CA	Hong Kong	HK	New Zealand	NZ	Sweden	SE
Chile	CL	Hungary	HU	Nigeria	NG	Switzerland	CH
China	CN	India	IN	Norway	NO	Taiwan	TW
Colombia	CO	Indonesia	ID	Oman	OM	Thailand	TH
Congo	CG	Israel	IL	Pakistan	PK	Turkey	TR
Costa Rica	CR	Italy	IT	Panama	PA	Uganda	UG
Croatia	HR	Jamaica	JM	Paraguay	PY	Ukraine	UA
Czech Republic	CZ	Japan	JP	Philippines	PH	United States	US
Denmark	DK	Kenya	KE	Poland	PL	Uruguay	UY
Ecuador	EC	Kuwait	KW	Portugal	PT	Uzbekistan	UZ
Egypt	EG	Libya	LY	Romania	RO	Vietnam	VN
El Salvador	SV	Luxembourg	LU	Russian Federation	RU	Zimbabwe	ZW

Troubleshooting

Symptom	Possible Cause	Correction
No power.	<ul style="list-style-type: none"> The power cord is disconnected. 	<ul style="list-style-type: none"> Plug the power cord into the wall outlet securely.
The power is on, but the player does not work.	<ul style="list-style-type: none"> No disc is inserted. 	<ul style="list-style-type: none"> Insert a disc. (Check the disc indicator in the display window is lit.)
No picture.	<ul style="list-style-type: none"> The TV is not set to receive DVD signal output. 	<ul style="list-style-type: none"> Select the appropriate video input mode on the TV.
	<ul style="list-style-type: none"> The video cable is not connected securely. 	<ul style="list-style-type: none"> Connect the video cable securely.
	<ul style="list-style-type: none"> The selected resolution is not capable with your TV. 	<ul style="list-style-type: none"> Select another resolution using RESOLUTION button.
No sound.	<ul style="list-style-type: none"> The equipment connected with the audio cable is not set to receive disc signal output. 	<ul style="list-style-type: none"> Select the correct input mode of the audio receiver so you can listen to the sound from the player.
	<ul style="list-style-type: none"> The power of the equipment connected with the audio cable is turned off. 	<ul style="list-style-type: none"> Turn on the equipment connected with the audio cable.
	<ul style="list-style-type: none"> The [AUDIO] options are set to the wrong position. 	<ul style="list-style-type: none"> Set the [AUDIO] options to the correct position (see page 20).
The player does not start playback.	<ul style="list-style-type: none"> An unplayable disc is inserted. 	<ul style="list-style-type: none"> Insert a playable disc. (Check the disc type and regional code.)
	<ul style="list-style-type: none"> The rating level is set. 	<ul style="list-style-type: none"> Change the rating level.
BD-Live feature does not work.	<ul style="list-style-type: none"> External USB device is not connected. 	<ul style="list-style-type: none"> Connect a FAT16 or FAT32 formatted USB device to the USB port (see page 9).
	<ul style="list-style-type: none"> Internet connection is not established. 	<ul style="list-style-type: none"> Ensure that the unit is correctly connected to the local area network and can access the internet (see page 16).
	<ul style="list-style-type: none"> The connected USB device is damaged. 	<ul style="list-style-type: none"> Format the USB device on your PC then re-connect it to the USB port on the unit.
The Remote Control does not work properly.	<ul style="list-style-type: none"> The Remote Control is not pointed at the remote sensor on the player. 	<ul style="list-style-type: none"> Point the Remote Control at the remote sensor of the player.
	<ul style="list-style-type: none"> The Remote Control is too far from the player. 	<ul style="list-style-type: none"> Operate the Remote Control closer to the player.

Resetting the Player

If you observe any of the following symptoms...

- When the Player is plugged in, but the power will not turn on or off.
- When the display window is not working.
- When the Player does not operate normally.

You can reset the Player as follows:

- Press and hold the POWER button for more than five seconds. This will force the Player to power off. Press the POWER button again to turn the Player back on.
- Unplug the power cord and then plug the power cord again after more than five seconds.

Customer Support

You can update the Player using the latest software to enhance the products operation and/or add new features. To obtain the latest software for this player (if updates have been made), please contact the following:

Call 1 (800) 243-0000 or

Visit <http://us.lgservice.com> and click on PRODUCT SUPPORT → Device Driver.

Specifications

General

Power requirements:	AC 120 V~, 60 Hz
Power consumption:	26W
Dimensions (W x H x D):	Approx. 16.9 x 2.3 x 10.9 inches (430 x 58 x 277 mm) without foot
Net Weight (Approx.):	6.6 lbs (3 kg)
Operating temperature:	41 °F to 95 °F (5 °C to 35 °C)
Operating humidity:	5 % to 90 %

Outputs

VIDEO OUT:	1.0 V (p-p), 75 Ω, sync negative, RCA jack x 1
COMPONENT VIDEO OUT:	(Y) 1.0 V (p-p), 75 Ω, sync negative, RCA jack x 1 (Pb)/(Pr) 0.7 V (p-p), 75 Ω, RCA jack x 2
HDMI OUT (video/audio):	19 pin (HDMI standard, Type A)
ANALOG AUDIO OUT:	2.0 Vrms (1 kHz, 0 dB), 600 Ω, RCA jack (L, R) x 1
DIGITAL OUT (COAXIAL):	0.5 V (p-p), 75 Ω, RCA jack x 1
DIGITAL OUT (OPTICAL):	3 V (p-p), Optical jack x 1

System

Laser:	Semiconductor laser, wavelength: 405nm / 650 nm
Signal system:	Standard NTSC Color TV system
Frequency response:	20 Hz to 20 kHz (48 kHz, 96 kHz, 192 kHz sampling)
Signal-to-noise ratio:	More than 100 dB (ANALOG OUT connectors only)
Harmonic distortion:	Less than 0.008%
Dynamic range:	More than 95 dB
LAN port:	Ethernet jack x 1, 10BASE-T/100BASE-TX
Accessories:	Video cable (1) Audio cable (1) Remote control (1) Batteries (2)

Note: Design and specifications are subject to change without prior notice.

The unit's Audio Output Specifications

Jack/ Setting Source Format	Analog Output Stereo	SPDIF (DIGITAL AUDIO OUT) *5		
		PCM Stereo	DTS Re-encode *3 *6	Primary Pass-Thru *1
Dolby Digital	PCM 2ch	PCM 2ch	DTS	Dolby Digital
Dolby Digital Plus	PCM 2ch	PCM 2ch	DTS	Dolby Digital
Dolby TrueHD	PCM 2ch	PCM 2ch	DTS	Dolby Digital
DTS	PCM 2ch	PCM 2ch	DTS	DTS
DTS-HD	PCM 2ch	PCM 2ch	DTS	DTS
Linear PCM 2ch	PCM 2ch	PCM 2ch	DTS	PCM 2ch
Linear PCM 5.1ch	PCM 2ch	PCM 2ch	DTS	PCM 2ch
Linear PCM 7.1ch	PCM 2ch	PCM 2ch	DTS	PCM 2ch

Jack/ Setting Source Format	HDMI OUT			
	PCM Stereo	PCM Multi-Ch *3	DTS Re-encode *6	Primary Pass-Thru *1, *2
Dolby Digital	PCM 2ch	PCM 5.1ch	DTS	Dolby Digital
Dolby Digital Plus	PCM 2ch	PCM 7.1ch	DTS	Dolby Digital Plus
Dolby TrueHD	PCM 2ch	PCM 7.1ch	DTS	Dolby TrueHD
DTS	PCM 2ch	PCM 5.1ch	DTS	DTS
DTS-HD	PCM 2ch	PCM 5.1ch	DTS	DTS-HD
Linear PCM 2ch	PCM 2ch	PCM 2ch	DTS	PCM 2ch
Linear PCM 5.1ch	PCM 2ch	PCM 5.1ch	DTS	PCM 5.1ch
Linear PCM 7.1ch	PCM 2ch	PCM 7.1ch	DTS	PCM 7.1ch *4

Notes:

- *1 The secondary and interactive audio may not be included in the output bitstream if [SPDIF] or [HDMI] option is set to [Primary Pass-Thru]. (Except LPCM Codec : the output always include interactive and secondary audio.)
- *2 This player automatically selects the HDMI audio according to the decoding capability of the connected HDMI device even though [HDMI] option is set to [Primary Pass-Thru].
- *3 The [PCM Multi-CH]/[Primary Pass-Thru] setting of the [HDMI] option and [DTS re-encode] setting of the [SPDIF] option cannot be set together. If you set the [HDMI] option to [PCM Multi-CH] or [Primary Pass-Thru], the [SPDIF] option is set to [PCM Stereo] automatically. Also, if you set the [SPDIF] option to [DTS Re-encode] and the [HDMI] option is set to [PCM Stereo] automatically.
- *4 The LPCM audio recorded at 192kHz sampling frequency will be outputted as stereo sound.
- *5 On the PCM audio output, the sampling frequency of HDMI/SPDIF (DIGITAL AUDIO OUT) is limited to 96 kHz.
- *6 If the [HDMI] or [SPDIF] option is set to [DTS re-encode], the audio output is limited to 48 kHz and 5.1 ch. If the [HDMI] or [SPDIF] option is set to [DTS re-encode], the DTS Re-encode audio is outputted for BD-ROM discs, and the original audio is outputted for the other discs (like [Primary Pass-Thru]).
- If [HDMI] option is set to [PCM Multi-CH] and [SPDIF] option is set to [Primary Pass-Thru] when the unit plays back Dolby Digital Plus audio, SPDIF (DIGITAL AUDIO OUT) jack is limited to "PCM 2ch".
- If the HDMI connection is version 1.3 and Dolby Digital Plus/Dolby TrueHD/DTS-HD is outputted from HDMI OUT jack, SPDIF (DIGITAL AUDIO OUT) jack is limited to "PCM 2ch" (When the HDMI and SPDIF are connected simultaneously).
- The audio is always output as PCM 48kHz/16 bit during Audio CD or MP3/WMA file is playing back.
- The Dolby TrueHD audio recorded on the BD disc is consist of Dolby Digital and TrueHD audio. The Dolby Digital audio is outputted through DIGITAL AUDIO OUT jacks and DD displays on the screen if the player does not use Lossless audio. (for example, when [HDMI] is set to [PCM Stereo] or [DTS Re-encode] and [SPDIF] is set to [Primary Pass-Thru])

Software Update

You can update the Player using the latest software to enhance the products operation and/or add new features. You can update the software by connecting the unit directly to the software update server.

Step 1: Check the Network Connection

See page 16.

Step 2: Configuring Network Settings

See page 22.

Step 3: Checking Network Configuration

1. Select [NETWORK] on the [Setup] menu.
2. Select [IP Mode] option on the [NETWORK] menu.
3. Check the Network status indicator shown above the menu. (The Network status indicator changes according to Network configuration.)



Able to use network



Testing Network



Unable to use network

Step 4: Updating Software

Cautions:

- Before updating the software in your player, remove any disc and USB Device from the player.
- Before updating the software in your player, turn the player off and then turn it back on.
- **During the software update procedure, do not turn off the player or disconnect AC power, or do not press any button.**
- If you cancel the update. turn off the power and turn it on for stable performance.
- This unit cannot be updated to previous software version.

1. Press Home
2. Use ◀ / ▶ to select the [Setup] then press ENTER.
3. Select [Software Update] option on the [OTHERS] menu then press ▶ or ENTER.



4. The player will check for the newest update.

Caution: Pressing ENTER while checking for the update will end the process.

Note: If there is no update available, the Message, "No update is found." appears. Press ENTER to return to the Home Menu.

5. If newer version exists, the message "A new update is found. Do you want to download it?" appears.
6. Select OK to download the update. (Selecting [CANCEL] will end the update.)
7. The player starts downloading the newest update from the server. (Downloading will take about 80 seconds at the network speed of 4Mbps Speed.)
8. When downloading is completed, the message, "Download is complete. Do you want to update?" appears.

Current software version



Downloaded software version

9. Select OK to start updating. (Selecting [CANCEL] will end the update and downloaded file will not be re-usable. To update software the next time, the software update procedure has to be started from the beginning again.)

Caution: Do not turn off the power during the software update.

Note: If the software includes the driver update, disc tray may open during the process.

10. When update is completed, the message, "Update is complete." will appear, and the power will turn off automatically after 5 seconds.
11. Turn the power back on. The system now operates with the new version.
12. After completing the update process, repeat procedures 1-4 in Step 4 and check if there are no more updates available.

Tip

The Software Update function may not work properly depending on your internet environment. In this case, you can obtain the latest software from the authorized LG Electronics Service Center then update your player. Refer to "Customer Support" on page 38.

Open source software notice

The following GPL executables and LGPL libraries used in this product are subject to the GPL2.0/LGPL2.1 License Agreements:

GPL EXECUTABLES:

Linux kernel 2.6, bash, busybox, dhcpcd, mtd-utils, net-tools, procps, sysutils, tinylogin

LGPL LIBRARIES:

uClibc, DirectFB, iconv, cairo

LG Electronics offers to provide source code to you on CD-ROM for a charge covering the cost of performing such distribution, such as the cost of media, shipping and handling upon e-mail request to LG Electronics at: opensource@lge.com

This offer is valid for a period of three(3) years from the date of the distribution of this product by LG Electronics.

You can obtain a copy of the GPL, LGPL licenses from <http://www.gnu.org/licenses/old-licenses/gpl-2.0.html> and <http://www.gnu.org/licenses/old-licenses/lgpl-2.1.html>

This software is based in part on the work of the Independent JPEG Group copyright © 1991-1998, Thomas G. Lane.

This product includes

- Freetype library : Copyright © 2003 The FreeType Project (www.freetype.org).
- libpng library: Copyright © 2004 Glenn Randers-Pehrson
- Zlib compression library: Copyright © 1995-2002 Jean-loup Gailly and Mark Adler
- cryptographic software written by Eric Young (ey@cryptsoft.com).
- software written by Tim Hudson (tjh@cryptsoft.com).
- software developed by the OpenSSL Project for use in the OpenSSL Toolkit. (<http://www.openssl.org>)

This product includes other open source software.

- Copyright © David L. Mills 1992-2006
- Copyright © 1998-2003 Daniel Veillard.
- Copyright © 1998, 1999, 2000 Thai Open Source Software Center Ltd.
- Copyright © 1990 The Regents of the University of California.
- Copyright © 1998-2005 The OpenSSL Project.

All rights reserved.

Permission is hereby granted, free of charge, to any person obtaining a copy of this software and associated documentation files (the "Software"), to deal in the Software without restriction, including without limitation the rights to use, copy, modify, merge, publish, distribute, sublicense, and/or sell copies of the Software, and to permit persons to whom the Software is furnished to do so, subject to the following conditions:

THE SOFTWARE IS PROVIDED "AS IS", WITHOUT WARRANTY OF ANY KIND, EXPRESS OR IMPLIED, INCLUDING BUT NOT LIMITED TO THE WARRANTIES OF MERCHANTABILITY, FITNESS FOR A PARTICULAR PURPOSE AND NONINFRINGEMENT. IN NO EVENT SHALL THE AUTHORS OR COPYRIGHT HOLDERS BE LIABLE FOR ANY CLAIM, DAMAGES OR OTHER LIABILITY, WHETHER IN AN ACTION OF CONTRACT, TORT OR OTHERWISE, ARISING FROM, OUT OF OR IN CONNECTION WITH THE SOFTWARE OR THE USE OR OTHER DEALINGS IN THE SOFTWARE.

Notes

Reference



LG Electronics, Inc. Limited Warranty - USA

This LG Electronics product, will be repaired or replaced, at LG's option, if it proves to be defective in material or workmanship, under normal use, during the warranty period ("Warranty Period") listed below, effective from the date ("Date of Purchase") of original consumer purchase of the product. This warranty is good only to the original purchaser of the product and effective only when used in the United States, excluding U.S. Territories.

WARRANTY PERIOD: LABOR: 90 days from the Date of Purchase. PARTS: One Year from the Date of Purchase. * Parts replaced are warranted for the remaining portion of the original warranty period.	HOW SERVICE IS HANDLED: Call 1-800-243-0000 for instructions on getting the defective unit repaired or replaced. Please retain dated sales receipt and your box to return the unit to LG for repair or replacement. Shipping both ways will be paid by LG during the Warranty Period. After the Warranty Period, you pay inbound shipping charges and LG pays return shipping charges. Visit our website at: http://us.lgservice.com
---	---

THIS WARRANTY IS IN LIEU OF ANY OTHER WARRANTIES, EXPRESS OR IMPLIED, INCLUDING WITHOUT LIMITATION, ANY WARRANTY OF MERCHANTABILITY OR FITNESS FOR A PARTICULAR PURPOSE. TO THE EXTENT ANY IMPLIED WARRANTY IS REQUIRED BY LAW, IT IS LIMITED IN DURATION TO THE EXPRESS WARRANTY PERIOD ABOVE. LG ELECTRONICS WILL NOT BE LIABLE FOR ANY INCIDENTAL, CONSEQUENTIAL, INDIRECT, SPECIAL OR PUNITIVE DAMAGES OF ANY NATURE, EVEN IF ADVISED OF THE POSSIBILITY OF SUCH DAMAGES, INCLUDING WITHOUT LIMITATION, LOST REVENUES OR PROFITS, LOST OR CORRUPTED PROGRAMMING OR DATA, OR ANY OTHER DAMAGE WHETHER BASED IN CONTRACT, TORT OR OTHERWISE. Some states do not allow the exclusion or limitation of incidental or consequential damages or limitation on how long an implied warranty lasts, so the above exclusion or limitation may not apply to you. This warranty gives you specific legal rights and you may also have other rights that may vary from state to state.

THIS LIMITED WARRANTY DOES NOT APPLY TO:

- Damages or operating problems that result from shipping, installation, adjustment of user controls, calibration, maintenance or failure to maintain, or separate system components; and
- Damages or operating problems that result from normal wear and tear, misuse, abuse, operation outside environmental specifications or contrary to the requirements or precautions in the Operating Guide, accident, lightning strikes or other natural causes, unauthorized modification or alteration, incorrect electrical current or voltage, reception problem caused by inadequate home antenna or faulty antenna connections, computer software, institutional or commercial use, or other causes not arising out of defect in material or workmanship.

Therefore, the cost of repair or replacement of such defective product shall be borne by the consumer.

CUSTOMER INTER-ACTIVE CENTER NUMBERS:

For nearest Authorized Service Center, Where to buy, Product Assistance, or Customer Assistance	Call 1-800-243-0000 (24 hours a day, 365 days per year) and select appropriate options from the menu. Or visit our website at http://us.lgservice.com
--	---