



OWNER'S MANUAL

GAS RANGE

Read this owner's manual thoroughly before operating the appliance and keep it handy for reference at all times.

WARNING

If the information in this manual is not followed exactly, a fire or explosion may result causing property damage, personal injury or death.

- Do not store or use gasoline or other flammable vapors and liquids in the vicinity of this or any other appliance.
- **WHAT TO DO IF YOU SMELL GAS**
 - Do not try to light any appliance.
 - Do not touch any electrical switch.
 - Do not use any phone in your building.
 - Immediately call your gas supplier from a neighbor's phone. Follow the gas supplier's instructions.
 - If you cannot reach your gas supplier, call the fire department.
- Installation and service must be performed by a qualified installer, service agency, or the gas supplier.

WARNING

Never Operate the Top Surface Cooking Section of this Appliance Unattended

- Failure to follow this warning statement could result in fire, explosion, or burn hazard that could cause property damage, personal injury, or death.
- If a fire should occur, keep away from the appliance and immediately call your fire department.
- **DO NOT ATTEMPT TO EXTINGUISH AN OIL/GREASE FIRE WITH WATER.**

LRGL5825*

LRGL5823*

LRGL5821*



MFL33029630

(REV.15 230221)

www.lg.com

Copyright © 2022 LG Electronics Inc. All Rights Reserved.

TABLE OF CONTENTS

3 PRODUCT FEATURES

4 IMPORTANT SAFETY INSTRUCTIONS

12 PRODUCT OVERVIEW

- 12 Parts
- 12 Accessories

13 INSTALLATION

- 13 Before Installing the Range
- 14 Installing the Range
- 16 Providing Adequate Gas Supply
- 17 Connecting the Range to Gas
- 18 Electrical Connections
- 18 Sealing the Openings
- 19 Assembling the Surface Burners
- 19 Checking Ignition of the Surface Burners
- 20 Leveling the Range
- 20 Engaging the Anti-tip Device

21 OPERATION

- 21 Gas Surface Burners
 - 21 Burner Locations
 - 22 Using the Gas Surface Burners
 - 22 Setting the Flame Size
 - 22 In Case of Power Failure
 - 22 Range-Top Cookware
 - 23 Using a Wok
 - 23 Using Stove-Top Grills
 - 23 Using the Griddle
- 24 The Oven
- 25 Control Panel Overview
- 26 Changing Oven Settings
 - 26 Clock
 - 26 Minimum & Maximum Default Settings
 - 27 Oven Light
 - 27 Timer On/Off
 - Setting the Hour Mode
 - Setting the Convection Auto Conversion Function (Model LRGL5825*, LRGL5823*)
 - Adjusting the Oven Thermostat
 - Turning the Preheat Alarm Light On/Off
 - Adjusting the Beeper Volume
 - Selecting Fahrenheit or Celsius
- 29 Lockout (Model LRGL5825*/LRGL5823*)

- 29 Cook Time (Timed Cook)
- 30 Start Time (Delayed Timed Cook)
- 31 InstaView™ (Only Model LRGL5825*)
- 31 Removing and Replacing the Oven Racks
- 32 Recommended Baking and Roasting Guide
- 32 Bake
- 32 Convection Mode (Model LRGL5825* / LRGL5823*)
- 34 Broil
- 36 Sabbath Mode
- 36 Favorite (Only Model LRGL5825*)
- 36 Wi-Fi (Model LRGL5825*/LRGL5823*/LRGL5821*)
- 37 Remote Start (Model LRGL5825*/LRGL5823*/LRGL5821*)
- 37 Frozen Meal (Only Model LRGL5825*)
- 37 Slow Cook (Only Model LRGL5825*)
- 37 Warm / Keep Warm
- 37 Proof (Only Model LRGL5825*)
- 38 Air Fry (Only Model LRGL5825* / LRGL5823*)

41 SMART FUNCTIONS

- 41 LG ThinQ Application
- 42 FCC Notice
- 42 FCC RF Radiation Exposure Statement
- 43 Smart Diagnosis™ Feature

44 MAINTENANCE

- 44 Gas Surface Burners
- 45 Burner Grates
- 45 Cleaning the Cooktop Surface
- 45 Oven Air Vents
- 46 Control Panel
- 46 Front Manifold Panel and Knobs
- 46 Cleaning the Exterior
- 47 Door Care Instructions
- 47 EasyClean®
- 49 Self Clean (Only model LRGL5825*/LRGL5823*)
- 51 Changing the Oven Light
- 51 Removing and Replacing the Lift-Off Oven Doors and Drawer

53 TROUBLESHOOTING

- 53 FAQs
- 55 Before Calling for Service

57 LIMITED WARRANTY

PRODUCT FEATURES

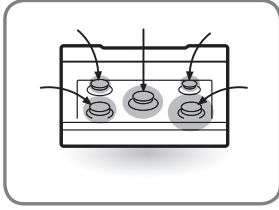

Multiple Gas Burner Sizes

Choose a burner to fit the size of the cookware.

Cooking multiple items at once is possible by using different burners at the same time.



Safe and Convenient Gas Range

Provides safety and convenience for cooking.

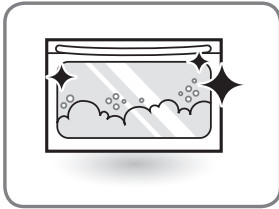

Self Clean (For Some Models) & EasyClean®

Useful for easy cleaning.

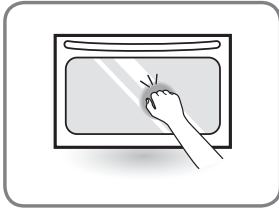

InstaView™

Two quick knocks on the sleek, mirrored glass panel allow you to see inside the easy access compartment without opening the door.

IMPORTANT SAFETY INSTRUCTIONS

Read and follow all instructions when using the range to prevent the risk of fire, electric shock, personal injury, or damage. This guide does not cover all possible conditions that may occur. Always contact your service agent or manufacturer about problems that you do not understand.

Download this owner's manual at: <http://www.lg.com>



This is the safety alert symbol. This symbol alerts you to potential hazards that can result in property damage and/or serious bodily harm or death.

All safety messages will follow the safety alert symbol and either the word WARNING or CAUTION. These words mean:



WARNING - Indicates a hazardous situation which, if not avoided, could result in death or serious injury.



CAUTION - Indicates a hazardous situation which, if not avoided, could result in minor or moderate injury.

ANTI-TIP DEVICE



WARNING

- ALL RANGES CAN TIP
 - INJURY TO PERSONS COULD RESULT
 - INSTALL ANTI-TIP DEVICES PACKED WITH RANGE
 - SEE INSTALLATION INSTRUCTIONS
 - A child or adult can tip the range and be killed.
 - Install the anti-tip device to the structure and/or the range. Verify the anti-tip device has been properly installed and engaged by following the guide of the Anti tip bracket template.
 - Engage the range to the anti-tip device by following the guide of the Anti tip bracket template. Ensure the anti-tip device is re-engaged when the range is moved by following the guide of the Anti tip bracket template.
 - Re-engage the anti-tip device if the range is moved. Do not operate the range without the anti-tip device in place and engaged.
 - See installation instructions for details.
 - Failure to do so can result in death or serious burns to children or adults.
- To avoid tipping, do not step or sit on the door. Install the anti-tip bracket packed with this range.
- The range could be tipped and injury might result from spilled hot liquid, food, or the range itself.
 - If the range is pulled away from the wall for cleaning, service, or any other reason, ensure that the anti-tip device is properly reengaged when the range is pushed back against the wall.

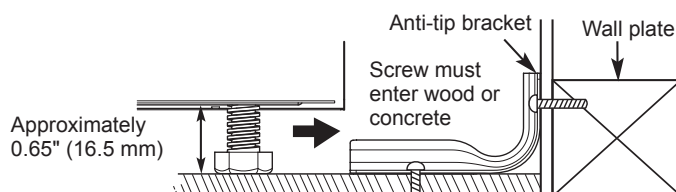

- To reduce the risk of the range tipping over, the range must be secured by properly installing the anti-tip device.
- To check that the anti-tip bracket is properly installed: Remove any items on the cooktop. Grasp the top rear edge of the range back guard and carefully attempt to tilt it forward. Verify that the anti-tip device is engaged.
- Remove the warming or storage drawers and visually inspect that the rear leveling leg is fully inserted into the anti-tip bracket.
- Refer to the installation section of the manual for proper anti-tip bracket installation.

IMPORTANT SAFETY NOTICE

Gas appliances can cause minor exposure to four potentially harmful substances, namely benzene, carbon monoxide, formaldehyde and soot, caused primarily by the imperfect combustion of natural or LP gas. Correctly adjusted burners, indicated by a bluish rather than a yellow flame, will minimize imperfect combustion. Exposure to these substances can be minimized by opening windows or using a ventilation fan or hood.

WARNING

- Never use your range as a space heater to heat or warm the room. Doing so may result in carbon monoxide poisoning and overheating of the oven.
- Never wear loose fitting or hanging garments while using the appliance. Be careful when reaching for items placed in cabinets over the range. Flammable materials could be ignited if brought in contact with flame or hot oven surfaces and may cause severe burns.
- Do not place or use combustible materials such as gasoline or other flammable vapors and liquids in the vicinity of this or any other appliance.
- Do not place flammable materials in the oven or near the cooktop.
- Do not allow cooking grease or other flammable materials in or near the range.
- Do not use water on grease fires. Never touch a flaming pan. Turn the controls off. Smother a flaming pan on a surface burner by covering the pan completely with a well-fitting lid, cookie sheet or flat tray. Use a multi-purpose dry chemical or foam-type fire extinguisher.
A grease fire can be put out by covering it with baking soda or, if available, by using a multi-purpose dry chemical or foam-type fire extinguisher.
Flame in the oven or the drawer can be smothered completely by closing the oven door or drawer and turning the control to off or by using a multi-purpose dry chemical or foam-type fire extinguisher.
- Do not use the oven or the drawer for storage.
- Let the burner grates and other surfaces cool before touching them.
- Never block the vents (air holes) of the range. They provide the air inlet and outlet necessary for the range to operate properly with correct combustion. Air openings are located at the rear of the cooktop, at the top and bottom of the oven door, and at the bottom of the range.
- Never obstruct the flow of combustion and ventilation air by blocking the oven vent or air intakes. Doing so restricts air to the burner and may result in carbon monoxide poisoning.
- Never cover any slots, holes or passages in the oven bottom or cover an entire rack with materials such as aluminum foil. Doing so blocks air flow through the oven and may cause carbon monoxide poisoning. Aluminum foil linings may also trap heat, causing a fire hazard.

 **WARNING**

- Large scratches or impacts to glass doors can lead to broken or shattered glass.
- Stepping, leaning or sitting on the doors or drawers of this range can result in serious injuries and also cause damage to the range. Do not allow children to climb or play around the range. The weight of a child on an open door may cause the range to tip, resulting in serious burns or other injury.
- Leak testing of the appliance must be conducted according to the manufacturer's instructions.
- Gas leaks may occur in the system and result in a serious hazard. Gas leaks may not be detected by smell alone. Gas suppliers recommend you purchase and install a UL-approved gas detector. Install and use in accordance with the gas detector manufacturer's instructions.
- Do not use commercial oven cleaners on the oven finish or around any part of the oven. They will damage the finish.
- To prevent staining or discoloration, clean appliance after each use.
- Do not attempt to open or close the door or operate the oven until the door is properly installed.
- Never place fingers between the hinge and front oven frame. Hinge arms are spring mounted. If accidentally hit, the hinge will slam shut against the oven frame and injure fingers.

 **CAUTION**

- Items of interest to children should not be placed in cabinets above the range or on the backsplash of the range - children climbing on the range to reach items could be seriously injured.
- Do not leave children alone or unattended where a range is hot or in operation. They could be seriously burned.
- Do not let anyone climb, stand or hang on the oven door, warming drawer or cooktop. They could damage the range or tip it over, causing severe personal injury.
- Wear gloves when cleaning the range to avoid injury or burns.
- Do not use the oven for storing food or cookware.
- To prevent damage to the oven door, do not attempt to open the door when Lock is displayed.
- Do not stand or place excessive weight on an open door. This could tip the range, break the door, or injure the user.
- Do not use delayed baking for highly perishable foods such as dairy products, pork, poultry, or seafood.

INSTALLATION SAFETY PRECAUTIONS

Have the installer show you the location of the range gas shut-off valve and how to shut it off if necessary.

WARNING

- Make sure your range is properly installed and grounded by a qualified installer, according to the installation instructions. Any adjustment and service should be performed only by qualified gas range installers or service technicians.
- Make sure your range is properly adjusted by a qualified service technician or installer for the type of gas (natural or LP) that is to be used. The range can be converted for use with either type of gas. See the installation instructions.
- These adjustments must be done by a qualified service technician according to the manufacturer's instructions and all codes and requirements of the authority having jurisdiction. Failure to follow these instructions could result in serious injury or property damage. The qualified agency performing these adjustments assumes responsibility for the conversion.
- Disconnect the electrical supply before servicing the appliance.
- Never use the appliance door as a step stool or seat, as this may result in possible tipping of the appliance and serious injuries.
- This product should not be installed below ventilation type hood systems that direct air in a downward direction.
Doing so may cause ignition and combustion problems with the gas burners resulting in personal injury and may affect the cooking performance of the unit.
- Plug your range into a 120-volt grounded outlet only. Do not remove the round grounding prong from the plug. If in doubt about the grounding of the home electrical system, it is your personal responsibility and obligation to have an ungrounded outlet replaced with a properly grounded, three-prong outlet in accordance with the National Electrical Code. Do not use an extension cord with this range.
- To prevent fire hazard or electrical shock, do not use an adapter plug, an extension cord, or remove the grounding prong from the electrical power cord. Failure to follow this warning can cause serious injury, fire or death.
- To prevent poor air circulation, place the range out of the kitchen traffic path and out of drafty locations.
- Do not attempt to repair or replace any part of the range unless it is specifically mentioned in this manual. All other services should be referred to a qualified technician.
- Make sure that all packaging materials are removed from the range before operating it to prevent fire or smoke damage should the packaging material ignite.

WARNING

- To shut off the gas supply to the range, close the range gas shutoff valve by turning it clockwise.

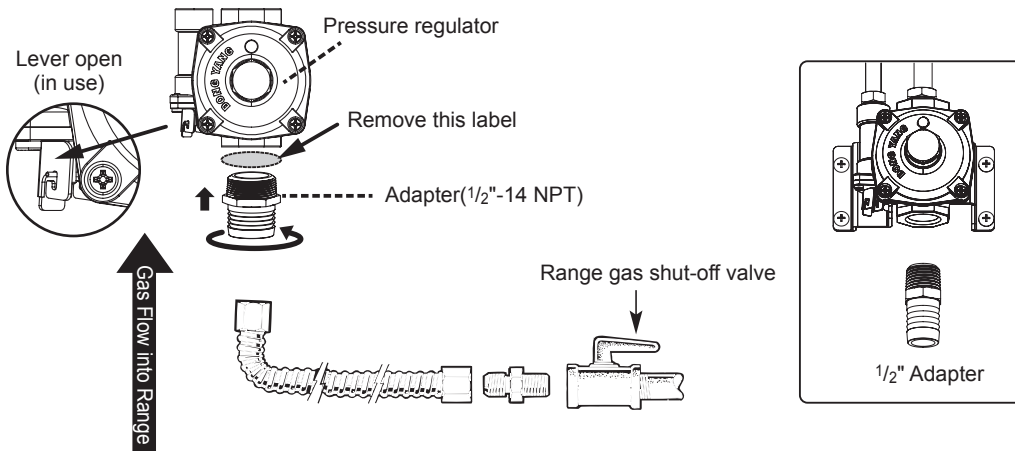

Installer: Inform the consumer of the location of the gas shut-off valve.

- After using the range for an extended period of time, high floor temperatures may result. Many floor coverings will not withstand this kind of use.
- Never install the range over vinyl tile or linoleum that cannot withstand such type of use. Never install it directly over interior kitchen carpeting.

SURFACE BURNERS**WARNING**

- Even if the top burner flame goes out, gas is still flowing to the burner until the knob is turned to the **Off** position. If you smell gas, immediately open a window and ventilate the area for five minutes prior to using the burner. Do not leave the burners on unattended.
- Use proper pan size.** Do not use pans that are unstable or that can be easily tipped. Select cookware with flat bottoms large enough to cover burner grates. To avoid spills, make sure the cookware is large enough to contain the food properly. This will both save cleaning time and prevent hazardous accumulations of food, since heavy spattering or spills left on the range can ignite. Use pans with handles that can be easily grasped and remain cool.

 **CAUTION**

- Be sure that all surface controls are set in the **Off** position prior to supplying gas to the range.
- Never leave the surface burners unattended at high flame settings. Boilovers may cause smoke and greasy spillovers that may ignite.
- Always turn the knobs to the **Lite** position when igniting the top burners and make sure the burners have ignited.
- Control the top burner flame size so it does not extend beyond the edge of the cookware. Excessive flame is hazardous.
- Only use dry pot holders- moist or damp pot holders on hot surfaces may result in burns from steam. Do not let pot holders come near open flames when lifting cookware. Do not use towels or other bulky cloth items. Use a pot holder.
- If using glass cookware, make sure the cookware is designed for range-top cooking.
- To prevent burns from ignition of flammable materials and spillage, turn cookware handles toward the side or back of the range without extending them over adjacent burners.
- Never leave any items on the cooktop. The hot air from the vent may ignite flammable items and will increase pressure in closed containers, which may cause them to burst.
- Carefully watch foods being fried at a high flame setting.
- Always heat fat slowly, and watch as it heats.
- If frying combinations of oils and fats, stir together before heating.
- Use a deep fat thermometer if possible to prevent overheating fat from heating beyond the smoking point.
- Use the least possible amount of fat for effective shallow or deep fat frying. Filling the pan with too much fat can cause spillovers when food is added.
- Do not cook foods directly on an open flame on the cooktop.
- Do not use a wok on the surface burners if the wok has a round metal ring that is placed over the burner grate to support the wok. This ring acts as a heat trap, which may damage the burner grate and burner head. It may also cause the burner to work improperly. This may cause carbon monoxide levels which are higher than what is allowed by current standards, resulting in a health hazard.
- Foods for frying should be as dry as possible. Frost or moisture on foods can cause hot fat to bubble up and spill over the sides of the pan.
- Never try to move a pan of hot fat, especially a deep fryer. Wait until the fat is cool.
- Do not place plastic items on the cooktop- they may melt if left too close to the vent.
- Keep all plastics away from the surface burners.
- To prevent burns, always be sure that the controls for all burners are in the **Off** position and all grates are cool before attempting to remove them.
- If you smell gas, turn off the gas to the range and call a qualified service technician. Never use an open flame to locate a leak.
- Always turn the knobs to the **Off** position before removing cookware.
- Do not lift the cooktop. Lifting the cooktop can cause damage and improper operation of the range.
- If the range is located near a window, do not hang long curtains that could blow over the surface burners and catch on fire.
- Use care when cleaning the cooktop. The pointed metal ends on the electrodes could cause injury.

BROILER

Always use a broiler pan and a grid for excess fat and grease drainage. This will help to reduce splatter, smoke, and flare-ups.

WARNING

When using the broiler, the temperature inside the oven will be extremely high. Take caution to avoid possible burns by:

- Keeping the door closed when broiling (refer to Broil section of the manual)
- Always wearing oven mitts when inserting or removing food items

COOK MEAT AND POULTRY THOROUGHLY

To protect against food-borne illnesses, cook meat and poultry thoroughly—ground beef to at least an INTERNAL temperature of 160 °F, poultry to at least an INTERNAL temperature of 165 °F and beef, pork, veal & lamb steaks & chops to at least an INTERNAL temperature of 145 °F.

SELF CLEANING OVEN

Make sure to wipe off excess spillage before operating the self clean function.

CAUTION

- Do not leave food, cooking utensils, racks, etc. in the oven during the self clean cycle.
- Do not use oven cleaners. No commercial oven cleaner or oven liner protective coating of any kind should be used in or around any part of the oven. Residue from oven cleaners will damage the inside of the oven when the self clean cycle is used.
- Remove oven racks and other items from the oven before starting the self clean cycle.
- Only clean the parts listed in this manual.
- Do not clean the door gasket. The door gasket is necessary for a good seal. Care should be taken not to rub, damage or move the gasket.
- If the self cleaning mode malfunctions, turn the range off and disconnect the power supply. Have the range serviced by a qualified technician.
- It is normal for parts of the oven to become hot during a self clean cycle.
- Avoid touching the door, window or oven vent area during a clean cycle.

OVEN

When opening the door of a hot oven, stand away from the range. The hot air and steam that escape can cause burns to hands, face and eyes.

WARNING

- Never block any slots, holes or passages in the oven bottom or cover an entire rack with materials such as aluminum foil. Doing so blocks air flow through the oven and may cause carbon monoxide poisoning. Aluminum foil linings may trap heat, causing a fire hazard.
- Do not heat food in closed containers. Pressure inside the container could increase and cause the container to burst, resulting in injury.

 **WARNING**

- Do not line oven walls or bottom with aluminum foil or allow them to contact exposed heating elements in the oven. Doing so could create a fire hazard or cause damage to the range.
- Do not use the oven for storage. Items stored in the oven can catch on fire.
- Keep the oven free from grease buildup.
- Insert the oven racks in the desired position while the oven is cool.
- To prevent burns when removing food, slide racks out until the stop engages, then remove food items. This may also protect you from getting burnt by touching hot surfaces of the door or oven walls.
- When placing or removing a griddle, always wear oven mitts.
- When using cooking or roasting bags in the oven, follow the manufacturer's directions.
- Use only glass cookware that is recommended for use in gas ovens.
- Always remove the broiler pan from the range after you finish broiling. Grease left in the pan can catch fire if the oven is used without removing the grease from the broiler pan.
- If meat is too close to the flame while broiling, the fat may ignite. Trim excess fat to prevent excessive flare-ups.
- Make sure the broiler pan is in place correctly to minimize the possibility of grease fires.
- If you have a grease fire in the broiler pan, press the **Clear/Off** and keep the oven door closed to contain the fire until it burns out.
- For safety and better cooking performance, always bake and broil with the oven door closed. Open door baking or broiling can cause damage to the knobs or valves. Do not leave the oven door open during cooking or while the oven is cooling down.

ENERGY SAVING TIPS

- Multiple-rack cooking saves time and energy. Whenever possible, cook foods requiring the same cooking temperature together in one oven.
- For optimal performance and energy savings, follow the guides on page 32 for proper rack and pan placements.
- Match the size of the cookware to the amount of food being cooked to save energy when heating. Heating $\frac{1}{2}$ quart of water requires more energy in a 3-quart pot than in a 1-quart pot.
- Use cookware with flat bottoms to provide the best contact with the cooktop surface when cooking on the glass-ceramic cooktop.
- Match the size of the cooktop burner or element to the size of the cookware in use. Using a large element for a small pan wastes heating energy, and the exposed surface of the element is a burn or fire hazard.
- Reduce energy use by cleaning light oven soils with the EasyClean® feature instead of self-clean.
- Avoid opening the oven door more than necessary during use. This helps the oven maintain temperature, prevents unnecessary heat loss, and saves on energy use.

Read all instructions before using the appliance.

SAVE THESE INSTRUCTIONS

PRODUCT OVERVIEW

Parts

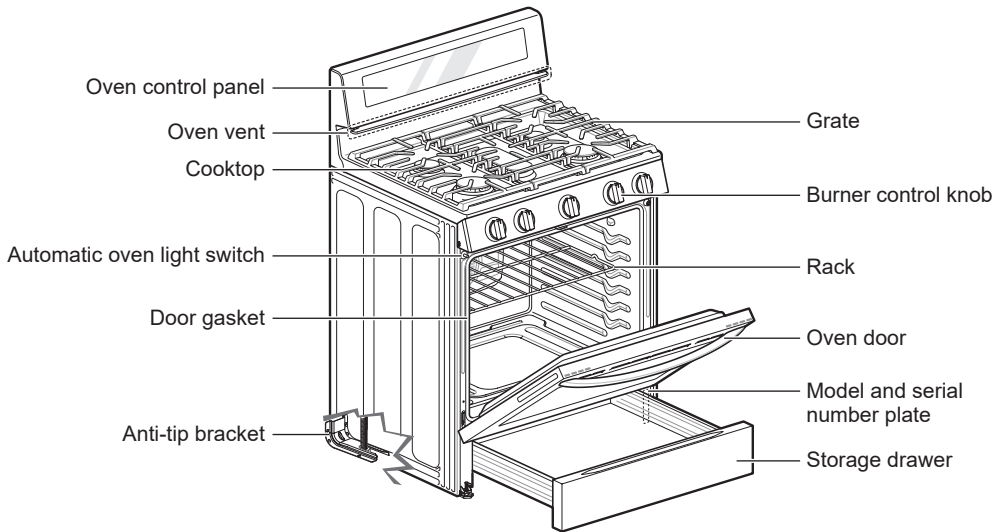

Accessories

Included Accessories



Standard rack

- Model LRGL5825* (3ea)
- Model LRGL5823*/LRGL5821* (2ea)

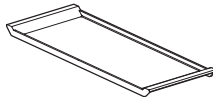

Griddle (1ea)

- Model LRGL5825*/LRGL5823*



Owner's manual (1ea)

Anti-tip kit

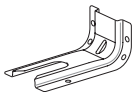

Anti-tip (1ea)



Screws (4ea)



Anchors (4ea)

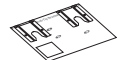

Template (1ea)

LP nozzle conversion kit

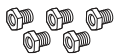

Cooktop Nozzles (5ea)



Oven Nozzles (2ea)

Optional Accessories

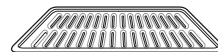

Grid

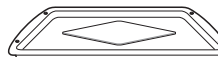

Broiler pan

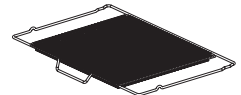

Air fry tray

NOTE

- Optional accessories are not included with the unit, these accessories are available for purchase at www.lg.com web page.
- Contact LG Customer Service at (LG U.S.) 1-800-243-0000 or (LG Canada) 1-888-542-2623, if any accessories are missing.
- For your safety and for extended product life, only use authorized components.
- The manufacturer is not responsible for product malfunction or accidents caused by the use of separately purchased, unauthorized components or parts.
- The images in this guide may be different from the actual components and accessories, which are subject to change by the manufacturer without prior notice for product improvement purposes.

INSTALLATION

Before Installing the Range

Make sure the range is properly installed and grounded by a qualified installer, according to the installation instructions. Any adjustment and service should be performed only by qualified gas range installers or service technicians.

In the Commonwealth of Massachusetts

- This product must be installed by a licensed plumber or gas fitter.
- When using ball type gas shut-off valves, they must be the T-handle type.
- When using a flexible gas connector, it must not exceed 3 feet in length.

Preparing for Installation

Tools Needed



Phillips screwdriver



Flat-blade screwdriver

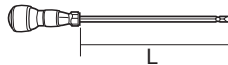

Flat-blade screwdriver
(simmer adjustment)
Diameter: $\frac{3}{32}$ " (2.4 mm)
L: 3" (76.2 mm)



Pencil and ruler

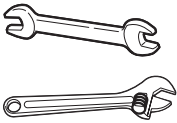

Open-end or adjustable
wrench

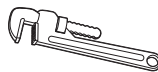

Pipe wrench (2)
(one for support)



Level

Materials You May Need

- Gas line shut-off valve
- Pipe joint sealant that resists action of natural and LP gases
- Flexible metal appliance connector ($\frac{3}{4}$ " or $\frac{1}{2}$ " NPT x $\frac{1}{2}$ " I.D.)
Never use an old connector when installing a new range.
- Flare union adapter for connection to gas supply line ($\frac{3}{4}$ " or $\frac{1}{2}$ " NPT x $\frac{1}{2}$ " I.D.)
- Flare union adapter for connection to pressure regulator on range ($\frac{1}{2}$ " NPT x $\frac{1}{2}$ " I.D.)
- Liquid leak detector or soapy water
- Lag bolt or $\frac{1}{2}$ " O.D. sleeve anchor (for concrete floors only)

Installing the Range

Unpacking and Moving the Range

CAUTION

- **You should use two or more people to move and install the range. (Excessive Weight Hazard)** Failure to do so can result in back or other injury.
- **Do not use the door handles to push or pull the range during installation or when moving the range out for cleaning or service.** Doing so can result in serious damage to the door of the range.

Remove packing material, protective film, tape and any temporary labels from your range before using. Do not remove any warning-type labels, the model and serial number label, or the Tech Sheet that is located on the back of the range.

To remove any remaining tape or glue, rub the area briskly with your thumb. Tape or glue residue can also be easily removed by rubbing a small amount of liquid dish soap over the adhesive with your fingers. Wipe with warm water and dry.

Do not use sharp instruments, rubbing alcohol, flammable fluids, or abrasive cleaners to remove tape or glue. These products can damage the surface of your range.

Your range is heavy and can be installed on soft floor coverings such as cushioned vinyl or carpeting. Use care when moving the range on this type of flooring. Use a belt when moving the range to prevent damaging the floor. Or slide the range onto cardboard or plywood to avoid damaging the floor covering.

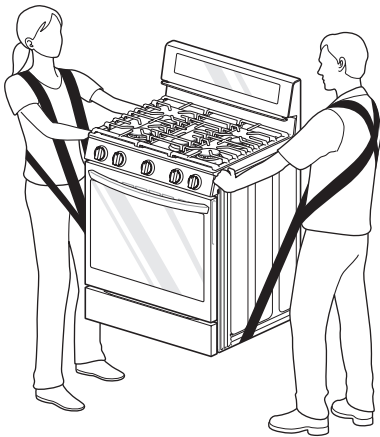

Choosing the Proper Location

Do not locate your range where it may be subject to strong drafts. Any openings in the floor or wall behind the range should be sealed. Make sure the openings around the base of the range that supply fresh air for combustion and ventilation are not blocked by carpeting or woodwork.

Your range, like many other household units, is heavy and can be installed on soft floor coverings such as cushioned vinyl or carpeting. Use care when moving the range on this type of flooring.

This appliance must not be installed with a ventilation system that blows air downward toward the range. This type of ventilation system may cause ignition and combustion problems with the gas cooking appliance resulting in personal injury or unintended operation.

When the floor covering ends at the front of the range, the area that the range will be installed on should be built up with plywood to the same level or higher than the floor covering. This will allow the range to be moved for cleaning and servicing, as well as provide proper air flow to the range.

Also, make sure the floor covering can resist temperatures of at least 167 °F (75 °C). See the Installation Safety Precautions included in this manual.

Make sure the wall coverings around your range can resist the heat generated up to 194 °F (90 °C) by the range. See the Precautions Safety Precautions included in this manual.

Gas Pipe and Electrical Outlet Locations

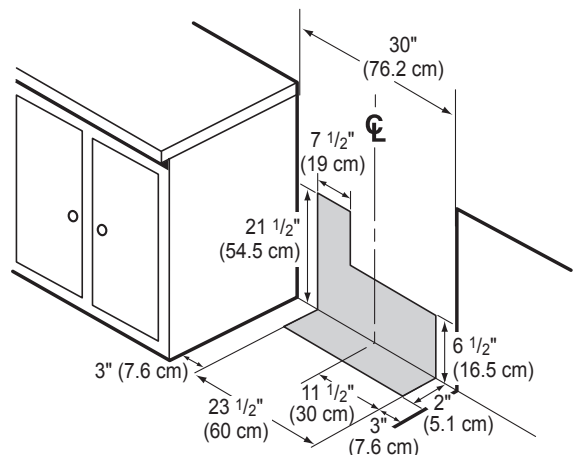

Dimensions and Clearances

Provide proper clearance between the range and adjacent combustible surfaces. These dimensions must be met for safe use of your range. The location of the electrical outlet and pipe opening (see Gas Pipe and Electrical Outlet Locations, page 14) may be adjusted to meet specific requirements. The range may be placed with 0" clearance (flush) at the back wall.

Installation Clearances

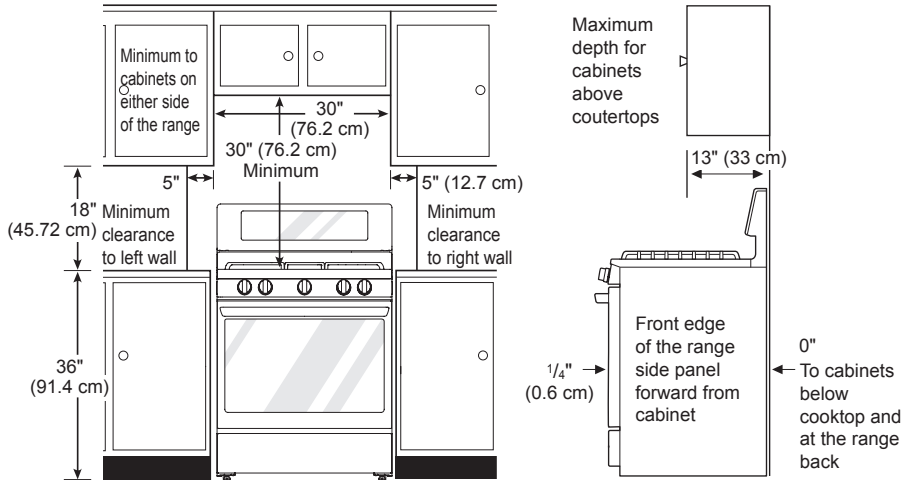

Dimensions

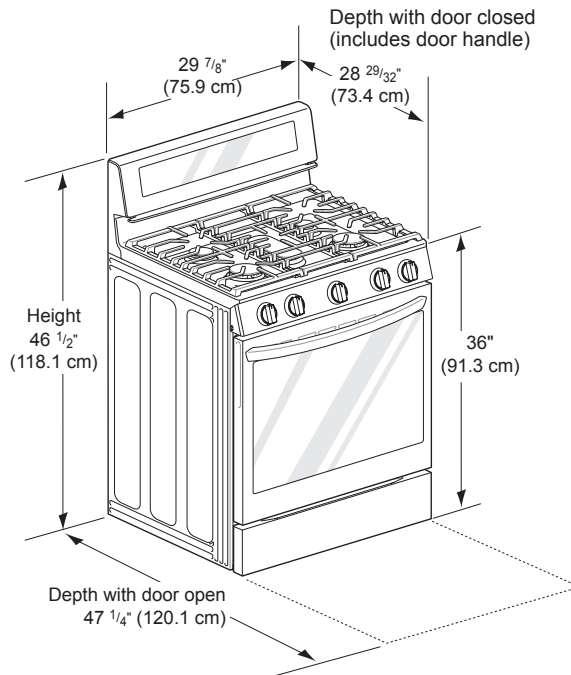

Installing the Anti-tip Device

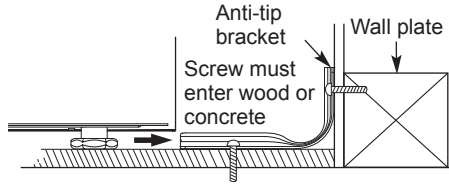

The anti-tip bracket is packaged with an installation template. The instructions include necessary information to complete the installation. Read and follow the range installation instruction sheet.

⚠ WARNING

- Range must be secured with an approved anti-tip device.
- The range could be tipped by standing, sitting or leaning on an open door if the range or anti-tip device is not properly installed.
- After installing the anti-tip device, verify that it is in place by carefully attempting to tilt the range forward.
- This range has been designed to meet all recognized industry tip standards for all normal conditions.
- The installation of the anti-tip device must meet all local codes for securing the appliance.
- The use of this device does not preclude tipping of the range when not properly installed.
- A child or adult can tip the range and be killed.
- Install the anti-tip device to the structure and/or the range. Verify the anti-tip device has been properly installed and engaged by following the guide of the Anti tip bracket template.
- Engage the range to the anti-tip device by following the guide of the Anti tip bracket template. Ensure the anti-tip device is re-engaged when the range is moved by following the guide of the Anti tip bracket template.
- Re-engage the anti-tip device if the range is moved. Do not operate the range without the anti-tip device in place and engaged.
- See installation instructions for details.
- Failure to do so can result in death or serious burns to children or adults.

Providing Adequate Gas Supply

The range is designed to operate at a pressure of 5" of water column on natural gas or 10" of water column on LP.

Make sure you are supplying your range with the type of gas for which it is configured.

This range is convertible for use on natural or LP gas. When using this range on LP gas, conversion must be made by a qualified LP installer before attempting to operate the range.

For proper operation, the pressure of natural gas supplied to the regulator must be between 5" and 13" of water column.

For LP gas, the pressure supplied to the regulator must be between 10" and 13" of water column. When checking for correct operation of the regulator, the inlet pressure must be at least 1" more than the operating (manifold) pressure as given above.

The pressure regulator located at the inlet of the range must remain in the supply line regardless of which type of gas is being used.

A flexible metal appliance connector used to connect the range to the gas supply line should have an I.D. of $\frac{5}{8}$ " and a maximum length of 5 feet. In Canada, flexible connectors must be single wall metal connectors less than 6 feet in length.

Connecting the Range to Gas

Shut off the range gas supply valve before removing the old range and leave it off until the new hook-up has been completed.

Because hard piping restricts movement of the range, the use of a CSA International-certified flexible metal appliance connector should be used unless local codes require a hard-piped connection.

A manual valve shall be installed in an accessible location in the gas piping external to the appliance for the purpose of turning on or shutting off gas to the appliance.

Never reuse an old connector when installing a new range.

To protect against gas leaks, use a qualified pipe joint sealant on all external threads.

- 1 Install a male 1/2" or 3/4" flare union adapter to the NPT internal thread of the manual shut-off valve, taking care to back-up the shut-off valve to keep it from turning.
- 2 Install a male 1/2" flare union adapter to the 1/2" NPT internal thread at the inlet of the pressure regulator. Use a backup wrench on the pressure regulator fitting to prevent damage.

Check that the gas pressure regulator valve is in the open position.

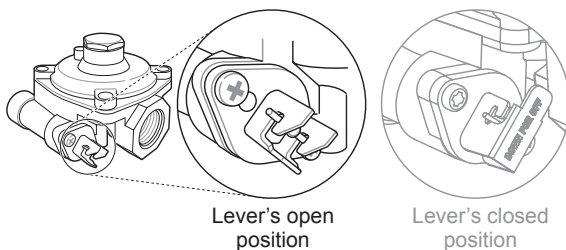

NOTE

- The gas pressure regulator valve is open when shipped. If the range does not work properly after installation, make sure the regulator valve is still open.

- 3 Connect a flexible metal appliance connector to the adapter on the range. Position the range to permit connection at the shut-off valve.

- 4 When all connections have been made, be sure all range controls are in the OFF position and the pressure regulator valve is open before turning on the main gas supply valve. Gas leaks may occur in your system and create a hazard. Gas leaks may not be detected by smell alone.

Check all gas connection joints and fittings for leaks with a non-corrosive leak detection fluid, then wipe off.

Gas suppliers recommend you purchase and install a UL approved gas detector. Install and use in accordance with the installation instructions.

! WARNING

- Do not use a flame to check for gas leaks.
- Isolate the range from the gas supply system by closing its individual shut-off valve during any pressure testing of the gas supply system at test pressures equal to or less than 1/2 psi (3.5 kPa).
- The appliance and its individual shut-off valve must be disconnected from the gas supply piping system during any pressure testing of that system at test pressures in excess of 1/2 psi (3.5 kPa).

Flexible Connector Hookup

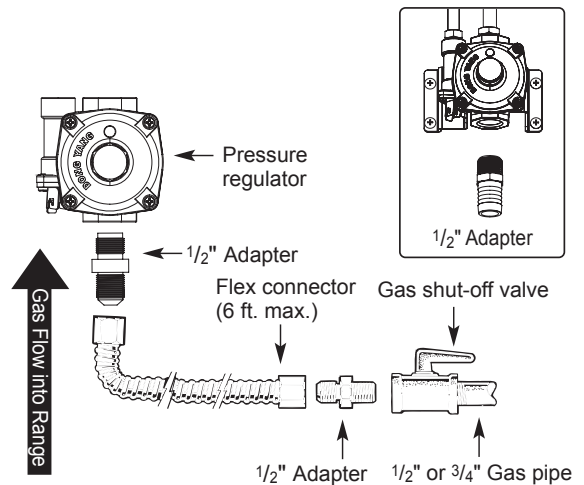

Installer: Inform the consumer of the location of the gas shut-off valve.

Pressure Regulator Position

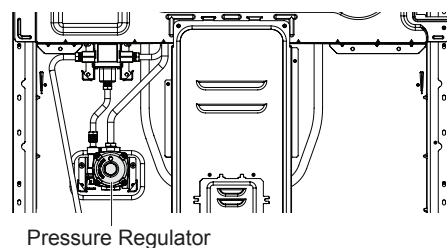

Electrical Connections

Electrical Requirements

120 Volt, 60 Hz, properly grounded dedicated circuit protected by a 15 or 20 Amp circuit breaker, or slow blow fuse.

If an external electrical source is utilized, a statement that the appliance, when installed, must be electrically grounded in accordance with local codes or, in the absence of local codes, with the National Electrical Code, NFPA 70 or the Canadian Electric Code, CSA C22.1-02.

Grounding

IMPORTANT: FOR PERSONAL SAFETY, THIS APPLIANCE MUST BE PROPERLY GROUNDED.

The power cord of this appliance is equipped with a 3-prong (grounding) plug which mates with a standard 3-prong grounding wall receptacle to minimize the possibility of electric shock hazard from this appliance.

The customer should have the wall receptacle and circuit checked by a qualified electrician to make sure the receptacle is properly grounded.

Where a standard two-prong wall receptacle is encountered, it is the personal responsibility and obligation of the customer to have it replaced with a properly grounded three-prong wall receptacle.

DO NOT, UNDER ANY CIRCUMSTANCES, CUT OR REMOVE THE THIRD (GROUND) PRONG FROM THE POWER CORD.

Preferred Method



CAUTION

Have the circuit checked by a qualified electrician to make sure the receptacle is properly grounded.

Do not use an adapter plug. Disconnecting of the power cord places undue strain on the adapter and leads to eventual failure of the adapter ground terminal.

Installation must conform with local codes or, in the absence of local codes, with the National Fuel Gas Code, ANSI Z223.1/NFPA 54 or, in Canada, the Natural Gas and Propane Installation Code, CSA B149.1.

The installation of appliances designed for mobile home installation must conform with the Manufactured Home Construction and Safety Standard, Title 24 CFR, Part 3280 (formerly the Federal Standard for Mobile Home Construction and Safety, Title 24, HUD, Part 280) or, when such standard is not applicable, the Standard for Manufactured Home Installations, latest edition (Manufactured Home Sites, Communities and Set-Ups), ANSI A225.1, latest edition, or with local codes. In Canada, mobile home installation must be in accordance with the current CAN/CSA Z240/MH Mobile Home Installation Code.

Sealing the Openings

Seal any openings in the wall and floor after electrical and gas supplies are completed.

Assembling the Surface Burners

CAUTION

Do not operate the burners without all parts in place.

Place the burner caps and heads on the cooktop. Make sure that the caps and heads are placed in the correct locations. There is one small, one medium, one large, and one extra large burner head and cap.

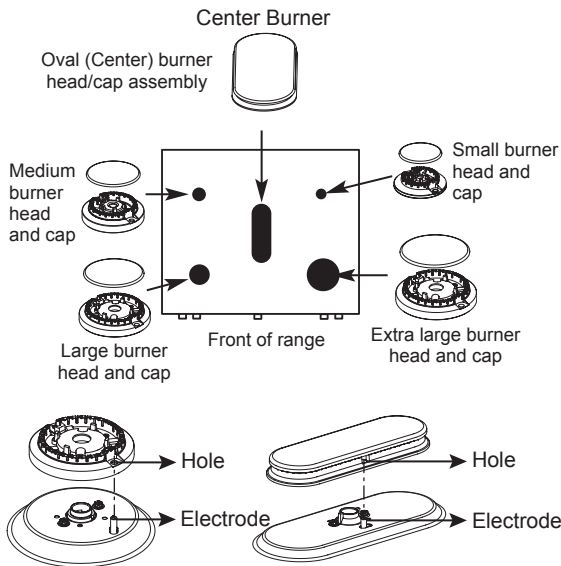

Make sure the hole in the burner head is positioned over the electrode.

Checking Ignition of the Surface Burners

Electric Ignition

Select a surface burner knob and simultaneously push in and turn to the **Lite** position. You will hear a clicking sound indicating proper operation of the spark module.

Once the air has been purged from the supply lines the burner should ignite within 4 seconds. After the burner ignites, rotate the knob out of the **Lite** position. Try each burner in succession until all burners have been checked.

Quality of Flames

The combustion quality of the burner flames needs to be confirmed visually.



A Yellow flames - Call for service.



B Yellow tips on outer cones - This is normal for LP gas.



C Soft blue flames - This is normal for natural gas.

NOTE

- With LP gas, some yellow tipping on outer cones is normal.

Adjusting the Surface Burner to the Low Flame (Simmer) Setting

- 1 Light all surface burners.
- 2 Turn the knob on the burner being adjusted to **Lo**.
- 3 Remove the knob.
- 4 Insert a small, flat-blade screwdriver with a minimum length of 3" (76.2 mm) and a diameter of $\frac{3}{32}$ " (2.4 mm) into the valve shaft.

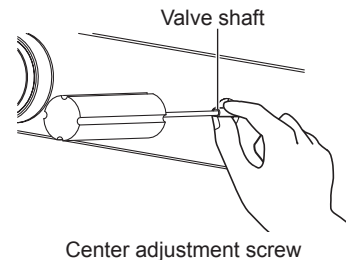

NOTE

Hold the valve shaft with one hand while turning the screw to adjust with the other.

- 5 Replace the knob.
- 6 Test the flame stability.
 - Test 1: Turn the knob from **Hi** to **Lo** quickly. If the flame goes out, increase the flame size and test again.
 - Test 2: With the burner on a **Lo** setting, open and close the oven door quickly. If the flame is extinguished by the air currents created by the door movement, increase the flame height and test again.
- 7 Repeat steps 1-6 for each surface burner.

Checking Operation of Bake / Broil Burners

To check ignition of the Bake burner, follow the steps below

- 1 Remove all packing materials from inside the oven cavity.
- 2 Press the **Bake**. 350 °F appears in the display.
- 3 Press the **Start**.

It may take between 30 and 90 seconds for the burner to start heating.

To check ignition of the Broil burner, follow the steps below

- 1 Press the **Broil**. **Hi** appears in the display.
- 2 Make sure the door is closed.
- 3 Press the **Start**.

It may take between 30 and 90 seconds for the burner to start heating.

NOTE

Do not try to light either the Bake or Broil burners during a power outage. The range has an electrical ignition system and cannot be used without power.

Adjusting Air Shutters (for LP Conversions)

The range comes from the factory with the air shutters adjusted for proper air flow for natural gas. If converted to LP, follow the instructions provided in the conversion kit to properly adjust the air shutters. LP conversion must be performed by a qualified technician.

Leveling the Range

Level the range by adjusting the leveling legs. Extending the legs slightly may also make it easier to insert the rear leg into the anti-tip bracket.

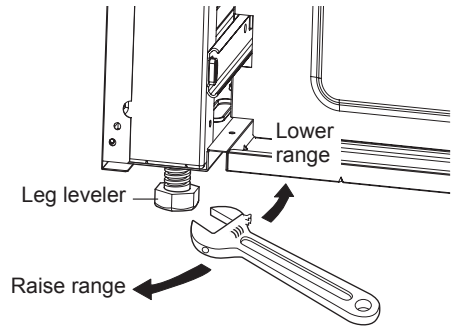

Use a level to check your adjustments. Place the level diagonally on the oven rack, and check each direction for level.

First check direction ①.

Then check direction ②. If the level doesn't show level on the rack, adjust the leveling legs.

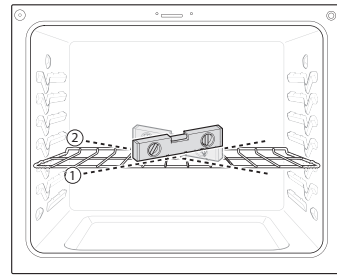

Engaging the Anti-tip Device

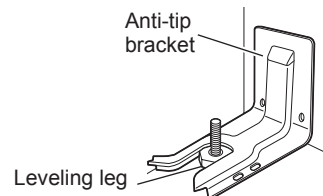

- 1 Slide the range against the wall, making sure the back leg slides into and engages the anti-tip bracket.
- 2 Check for proper installation by grasping the front edge of the cooktop and carefully attempting to tilt the range forward.

OPERATION

Gas Surface Burners

Before Use

Read all instructions before using.

Make sure that all burners are properly placed.

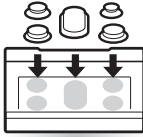

Make sure that all grates are properly placed before using the burner.

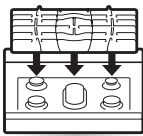

CAUTION

Do not operate the burner for an extended period of time without cookware on the grate.

The finish on the grate may chip without cookware to absorb the heat.

Make sure the burners and grates are cool before touching them, or placing a pot holder, cleaning cloth, or other materials on them.

Touching grates before they cool down may cause burns.



CAUTION

WHAT TO DO IF YOU SMELL GAS

- Open windows.
- Do not try to light any appliance.
- Do not touch any electrical switch.
- Do not use any phone in your building.
- Immediately call your gas supplier from a neighbor's phone. Follow the gas supplier's instructions.
- If you cannot reach your gas supplier, call the fire department.

Burner Locations

Your gas range cooktop has four or five sealed gas burners, depending on the model. These can be assembled and separated. Follow the guide below.

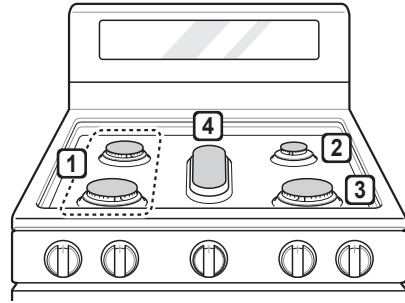

1 Medium and Large Burners

The medium and large burners are the primary burners for most cooking. These general purpose burners can be turned down from **Hi** to **Lo** to suit a wide range of cooking needs.

2 Small Burner

The smallest burner is used for delicate foods such as sauces or foods that require low heat for a long cooking time.

3 Extra Large Burner

The extra large burner is the maximum output burner. Like the other four burners, it can be turned down from **Hi** to **Lo** for a wide range of cooking applications. This burner is also designed to quickly bring large amounts of liquid to a boil. It can be used with cookware 10 inches or larger in diameter.

4 Oval Burner

The center, oval burner is for use with a griddle or oval pots.

Using the Gas Surface Burners

- 1 Be sure that all of the surface burners and grates are placed in the correct positions.
- 2 Place cookware on the grate.
- 3 Push the control knob and turn to the **LITE** position.

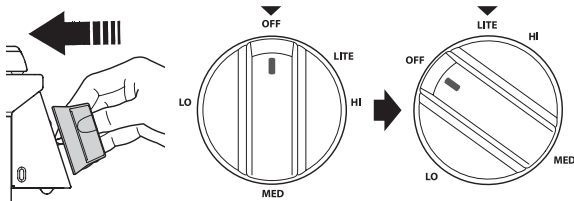

The electric spark ignition system makes a clicking noise. Once the burner is lit, turn the knob counterclockwise to the **HI** position to stop hearing the clicking noise.

- 4 Turn the control knob to control the flame size.

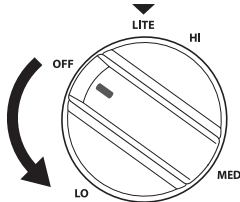

CAUTION

Do not attempt to disassemble or clean around any burner while another burner is on. All the burners spark when any burner is turned to **Lite**. An electric shock may result causing you to knock over hot cookware.

NOTE

Electric spark igniters from the burners cause a clicking noise. All the spark igniters on the cooktop will activate when igniting just one burner.

Setting the Flame Size

Watch the flame, not the knob, as you reduce heat. Match the flame size on a gas burner to the cookware being used for fastest heating.

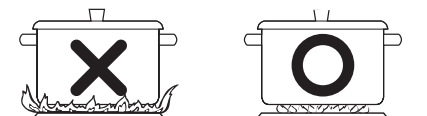

CAUTION

Never let the flames extend up the sides of the cookware.

NOTE

- The flames on the surface burners may burn yellow in the presence of high humidity, such as a rainy day or a nearby humidifier.
- After LP gas conversion, flames can be bigger than normal when you put a pot on the surface burner.

In Case of Power Failure

In case of a power failure, you can light the gas surface burners on the range with a match.

Surface burners in use when an electrical power failure occurs will continue to operate normally.

- 1 Hold a lit match to the burner, then push in the control knob.
- 2 Turn the control knob to the **Lo** position.

CAUTION

Use extreme caution when lighting burners with a match. It can cause burns and other damage.

Range-Top Cookware

Aluminum	Medium-weight cookware is recommended because it heats quickly and evenly. Most foods brown evenly in an aluminum skillet. Use saucepans with tight fitting lids when cooking with minimum amounts of water.
Cast-Iron	If heated slowly, most skillets will give satisfactory results.
Stainless Steel	This metal alone has poor heating properties and is usually combined with copper, aluminum or other metals for improved heat distribution. Combination metal skillets work satisfactorily if they are used with medium heat as the manufacturer recommends.
Enamelware	Under some conditions, the enamel of this cookware may melt. Follow cookware manufacturer's recommendations for cooking methods.
Glass	There are two types of glass cookware. Those for oven use only and those for top-of-range cooking.
Heatproof Glass Ceramic	Can be used for either surface or oven cooking. It conducts heat very slowly and cools very slowly. Check cookware manufacturer's directions to be sure it can be used on gas ranges.

Using a Wok

If using a wok, use a 14-inch or smaller flat-bottomed wok. Make sure that the wok bottom sits flat on the grate.

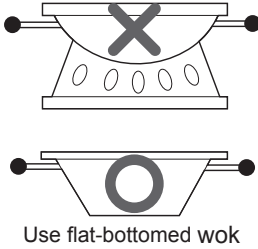

CAUTION

Do not use a wok support ring. Placing the ring over the burner or grate may cause the wok to work improperly, resulting in carbon monoxide levels above allowable standards. This can be hazardous to your health.

Using Stove-Top Grills

Do not place stove-top grills on the burner.



CAUTION

Do not use stove top grills on the surface burners. Using a stove top grill on the surface burner will cause incomplete combustion and can result in exposure to carbon monoxide levels above allowable current standards. This can be a health hazard.

Using the Griddle

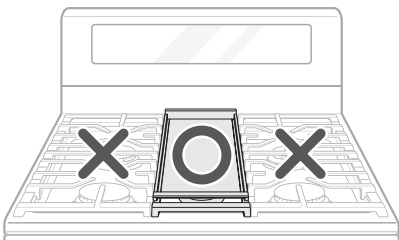

The non-stick coated griddle provides an extra-large cooking surface for meats, pancakes or other food usually prepared in a frying pan or skillet.

NOTE

It is normal for the griddle to become discolored over time.

How to Place the Griddle: The griddle can only be used with the center burner. The griddle must be properly placed on the center grate, as shown below.

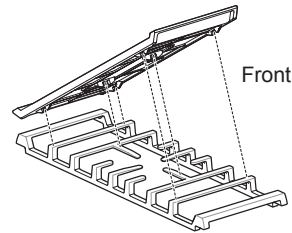

CAUTION

- Do not remove the center grate when using the griddle.
- Do not remove the griddle plate until the cooktop grates, surfaces and griddle plate have completely cooled.
- The griddle plate on the cooktop may become very hot when using the cooktop, oven or broiler systems. Always use oven mitts when placing or removing the griddle plate.

Preheat the griddle according to the guide below and adjust for the desired setting.

Type of Food	Preheat Conditions	Cook Setting
Warming Tortillas	-	HI
Pancakes	HI 10 min.	HI
Hamburgers	HI 10 min.	HI
Fried Eggs	HI 5 min.	HI
Bacon	HI 10 min.	HI
Breakfast Sausage Links	HI 10 min.	HI
Hot Sandwiches	HI 10 min.	HI

NOTE

After cooking on the griddle for an extended period, adjust the griddle temperature settings as the griddle retains heat.

IMPORTANT NOTES

- Avoid cooking extremely greasy foods as grease spillover can occur.
- The griddle can become hot when surrounding burners are in use.
- Do not overheat the griddle. This can damage the non-stick coating.
- Do not use metal utensils that can damage the griddle surface. Do not use the griddle as a cutting board.
- Do not place or store items on the griddle.

The Oven

Before Use

Read all instructions before using.

Make sure the electrical power cord and the gas valve are properly connected.

Confirm the correct use of the range for the type of food you will cook.

Make sure you know how to use the oven (temperature setting, time setting and recipe) for best results.

CAUTION

WHAT TO DO IF YOU SMELL GAS

- Open windows.
- Do not try to light any appliance.
- Do not touch any electrical switch.
- Do not use any phone in your building.
- Immediately call your gas supplier from a neighbor's phone. Follow the gas supplier's instructions.
- If you cannot reach your gas supplier, call the fire department.

NOTE

If using an oven thermometer in the oven cavity, temperatures may differ from the actual set oven temperature with all modes.

In case of power failure, do not use the oven.

The oven and broiler cannot be used during a power outage. If the oven is in use when a power failure occurs, the oven burner shuts off and cannot be relit until power is restored. Once power is restored, you will need to reset the oven (or Broil function).

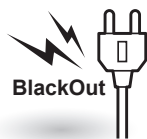

CAUTION

Do not attempt to operate the electric ignition during an electrical power failure.

Do not block, touch or place items around the oven vent during cooking.

Your oven is vented through ducts at the center above the burner grate. Do not block the oven vent when cooking to allow for proper air flow. Do not touch vent openings or nearby surfaces during any cooking operation.

– NEVER block this vent.

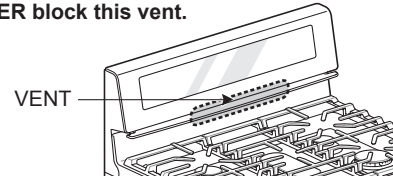

Do not cover the cooktop surface with aluminum foil. Blocking the oven vent can damage the control panel.

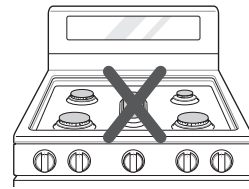

CAUTION

- Do not place plastic or flammable items on the cooktop. They may melt or ignite if left too close to the vent.
- Do not place closed containers on the cooktop. The pressure in closed containers may increase, which may cause them to burst.
- Metal items will become very hot if they are left on the cooktop, and could cause burns.
- Handles of pots and pans on the cooktop may become hot if left too close to the vent.
- **The edges of the range vent and vent trim are sharp and may become hot during operation.** Wear gloves when cleaning the range to avoid burns or other injury.

Do not cover racks or oven bottom with aluminum foil.



You may see condensation on the oven door glass.

As the oven heats up, the heated air in the oven may cause condensation to appear on the oven door glass. These water drops are harmless and will evaporate as the oven continues to heat up.

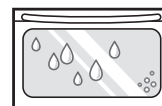

Control Panel Overview

Model LRGL5825*

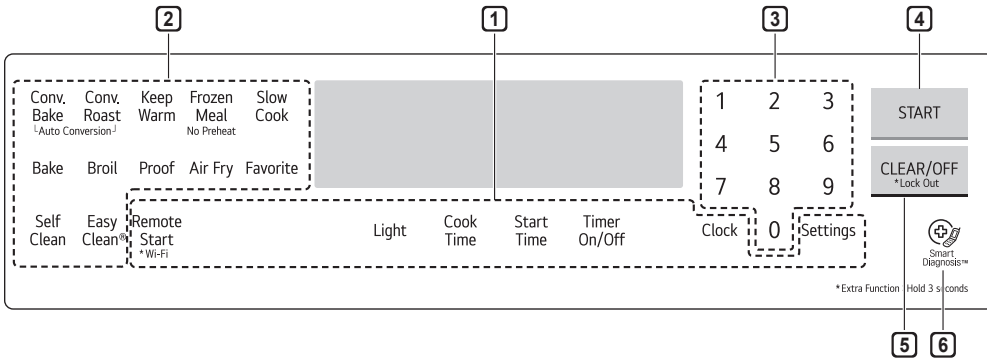

Model LRGL5823*

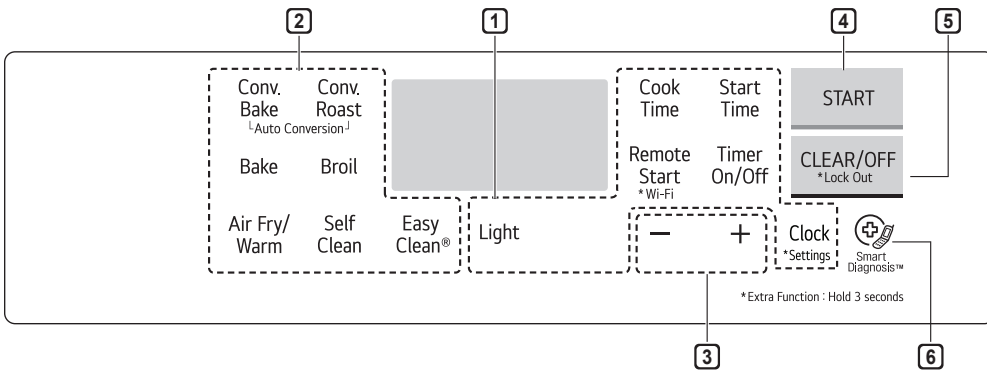

Model LRGL5821*

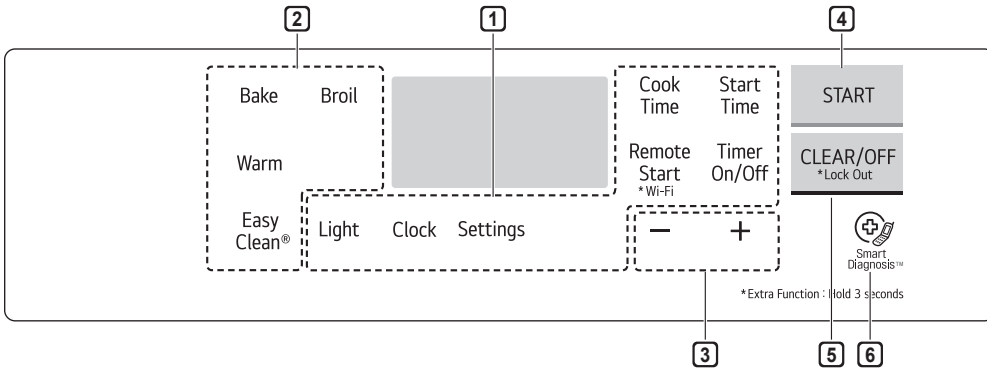

NOTE

For best results, press buttons in the center, even when activating a button's secondary function. The buttons may not work properly if pressed too far from the center.



1 Features

2 Oven Controls

3 Number Buttons or +/- Buttons

4 Start Button

5 Clear Off / Lockout Button

6 Smart Diagnosis™

Flashing Time

If your oven displays a flashing clock, press **Clock** or press any key to stop the flashing.

Secondary Function Input Guide (Settings, Wi-Fi)

- To activate a button's secondary function, press and hold the center of the button for 3 seconds, not over the name of the secondary function.

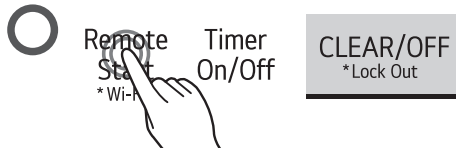

- The buttons may not work properly if pressed too far from the center.

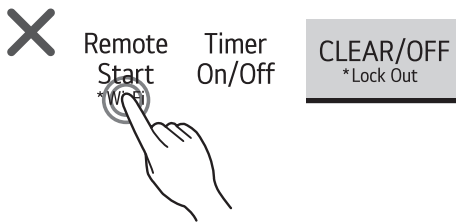

Changing Oven Settings

Clock

The clock must be set to the correct time of day in order for the automatic oven timing functions to work properly.

Model LRGL5825*

- Press **Clock**.
- Press **numbers** to enter the time.
- Press **Start**.

Model LRGL5823* / LRGL5821*

- Press **Clock**.
- Press the **+/-** buttons to set the time.
- Press **Start**.

NOTE

- The time of day cannot be changed during a timed baking or self-clean cycle (available on some models).
- To check the time of day when the display is showing other information, press **Clock**.
- If no other keys are pressed within 25 seconds of pressing **Clock**, the display reverts to the original setting.
- If the display time is blinking, you may have experienced a power failure. Reset the time.

Minimum & Maximum Default Settings

All of the features listed have a minimum and a maximum time or temperature setting that can be entered into the control. A beep sounds each time a button is pressed.

Two short tones sound if the entry of the temperature or time is below the minimum or above the maximum setting for the feature.

Feature	min. Temp. / Time	max. Temp. / Time	Default
Clock	12 Hr.	1:00 Hr. / min.	12:59 Hr. / min.
	24 Hr.	0:00 Hr. / min.	23:59 Hr. / min.
Timer (LRGL5825*)	0:01 min. / sec.	11:59 Hr. / min.	
Timer (LRGL5823* / LRGL5821*)	0:10 min. / sec.	11:59 Hr. / min.	
Cook Time	0:01 min.	11:59 Hr. / min.	
*Conv. Bake	300 °F / 150 °C	550 °F / 285 °C	350 °F (• 325 °F) / 12 Hr.
*Conv. Roast	300 °F / 150 °C	550 °F / 285 °C	350 °F (• 325 °F) / 12 Hr.
Broil	Lo	Hi	Hi / 3 Hr.
Bake	170 °F / 80 °C	550 °F / 285 °C	350 °F / 12 Hr.
Favorite ① - Bread	170 °F	550 °F	375 °F / 12 Hr.
Favorite ② - Meat	300 °F	550 °F	325 °F / 12 Hr.
Favorite ③ - Chicken	300 °F	550 °F	350 °F / 12 Hr.
Frozen Meal	300 °F	550 °F	400 °F / 12 Hr.
Air Fry	300 °F	550 °F	400 °F / 12 Hr.
Slow Cook	Lo	Hi	Hi / 12 Hr.
Proof			12 Hr.
Warm			3 Hr.
Self Clean (on some models)	3 Hr.	5 Hr.	4 Hr.
EasyClean®			10 min.

* Using Auto Conversion (Model LRGL5825* / LRGL5823*)

- Default cook mode times are without setting cook time.

Oven Light

The interior oven light automatically turns on/off when the door is opened and closed. Press **Light** or knock on the door glass twice to manually turn the oven light on/off.

The lamp of the oven will turn off after 1 minutes and 30 seconds to save power.

NOTE

- The oven light cannot be turned on if the Self Clean (Model LRGL5825*/LRGL5823*) function is active.

Timer On/Off

The Timer On/Off feature serves as an extra timer in the kitchen that beeps when the set time has run out. It does not start or stop cooking.

The Timer On/Off feature can be used during any of the other oven control functions.

- 1 Press **Timer On/Off** button once to set the time in hours and minutes, or press the button twice to set the time in minutes and seconds. **TIMER** flashes in the display.
- 2 Set the time.

Model LRGL5825*
Use the number buttons.

Model LRGL5823* / LRGL5821*
Use the +/- buttons.
- 3 Press **Timer On/Off** to start the Timer. The remaining time countdown appears in the display.

NOTE

If **Timer On/Off** is not pressed, the timer returns to the time of day.

- 4 When the timer reaches 0:00, End shows in the display. The clock beeps every 15 seconds until the Timer On/Off button is pressed.

NOTE

If the remaining time is not in the display, recall the remaining time by pressing **Timer On/Off**.

Cancelling the Timer

- 1 Press **Timer On/Off** once.
The display returns to the time of day.

Settings

Model LRGL5823*

Press and hold **Clock** for 3 seconds. Then press the **Clock** key repeatedly to toggle through and change oven settings.

Model LRGL5825* / LRGL5821*

Press the **Settings** button repeatedly to toggle through and change oven settings.

The oven settings allow you to:

- set the hour mode on the clock (12 or 24 hours)
- Set the Convection Auto Conversion Function (Model LRGL5825* / LRGL5823*)
- adjust the oven temperature
- activate/deactivate the preheating alarm light
- set the beeper volume
- switch the temperature scale between Fahrenheit and Celsius

Setting the Hour Mode

The control is set to use a 12-hour clock. To reset the clock to 24-hour mode, follow the steps below.

Model LRGL5825*

- 1 Press **Settings** button.
- 2 Press **1** to toggle between a 12-hour and 24-hour clock.
- 3 Press **Start** to accept the change.

Model LRGL5823* / LRGL5821*

- 1 **Model LRGL5823***
Press and hold the **Clock** button for 3 seconds.
- 2 **Model LRGL5821***
Press **Settings** button.
- 2 Press +/- to toggle between a 12-hour and 24-hour clock.
- 3 Press **Start** to accept the change.

Setting the Convection Auto Conversion Function (Model LRGL5825*, LRGL5823*)

When using convection bake and convection roast, the convection auto conversion feature will automatically convert entered regular baking temperatures to convection baking temperatures. When this feature is enabled, the display will show the actual converted temperature. For example, if you enter a regular recipe temperature of 350°F and press the START button, the display will show the converted temperature of **325°F**.

Model LRGL5825*

- 1 Press **Settings** repeatedly until **Auto** appears in the display.
- 2 Press **1** to switch Auto Conversion on or off.
- 3 Press **Start** to accept the change.

Model LRGL5823*

- 1 Press and hold the **Clock** button for 3 seconds.
- 2 Press **Clock** repeatedly until **Auto** appears in the display.
- 3 Press **+/-** button to switch Auto Conversion on/off.
- 4 Press **Start** to accept the change.

Adjusting the Oven Thermostat

This oven may cook differently from the one it replaced. Use the oven for a few weeks to become more familiar with it before changing the temperature settings. After becoming more familiar with the oven, if you notice a pattern of over- or underheating, follow these steps to adjust the thermostat.

NOTE

To begin, either raise or lower the thermostat 15 °F (8 °C). Try the oven with the new setting. If the oven still needs adjustment, raise or lower the thermostat again, using the first adjustment as a gauge. For example, if the adjustment was too much, raise or lower the thermostat 10 °F (5 °C). If the adjustment was not enough, raise or lower the thermostat 20 °F (12 °C). Proceed in this way until the oven is adjusted to your satisfaction.

Model LRGL5825*

- 1 Press **Settings** repeatedly until **AdJU** appears in the display.
- 2 Use the number keys to enter the number of degrees you want to adjust the oven temperature.
Press **Settings** again to add a minus sign if decreasing the temperature.
- 3 Press **Start** to accept the change.

Model LRGL5823* / LRGL5821*

- 1 **Model LRGL5823***
Press and hold the **Clock** button for 3 seconds. Press **Clock** repeatedly until **AdJU** appears in the display.

Model LRGL5821*

Press **Settings** repeatedly until **AdJU** appears in the display.

- 2 Set the number of degrees to adjust:
Press or press and hold the **+/-** buttons until the desired number of degrees appears in the display.
Press **Setting** or Press and hold the **Start Time** button for 3 seconds again to add a minus sign if decreasing the temperature.
- 3 Press **Start** to accept the change.

NOTE

- This adjustment does not affect the broiling. The adjustment is retained in memory after a power failure. The oven thermostat can be increased (+) or decreased (-) as much as 35 °F or 19 °C.
- Once the thermostat is increased or decreased, the display shows the adjusted temperature until it readjusts.

Turning the Preheat Alarm Light On/Off

When the oven reaches its set temperature, the preheating alarm light flashes 5 times or until the oven door is opened.

You can activate or deactivate the preheating alarm light.

Model LRGL5825*

- 1 Press **Settings** repeatedly until **PrE** appears in the display.
- 2 Press **1** to turn the light on/off.
- 3 Press **Start** to accept the change.

Model LRGL5823* / LRGL5821*

- 1 **Model LRGL5823***
Press and hold the **Clock** button for 3 seconds. Press **Clock** repeatedly until **PrE** appears in the display.

Model LRGL5821*

Press **Settings** repeatedly until **PrE** appears in the display.

- 2 Press **+/-** to turn the light on/off.
- 3 Press **Start** to accept the change.

Adjusting the Beeper Volume

Model LRGL5825*

- 1 Press **Settings** repeatedly until **Beep** appears in the display.
- 2 Press **1** repeatedly to select **Hi**, **Lo** or **Off**.
- 3 Press **Start** to accept the change.

Model LRGL5823* / LRGL5821*

- 1 **Model LRGL5823***
Press and hold the **Clock** button for 3 seconds. Press **Clock** repeatedly until **Beep** appears in the display.

Model LRGL5821*
Press **Settings** repeatedly until **Beep** appears in the display.
- 2 Press **+/-** to select **Hi**, **Lo** or **Off**.
- 3 Press **Start** to accept the change.

Selecting Fahrenheit or Celsius

Set the oven temperature display to show either Fahrenheit (°F) or Celsius (°C) units. The oven defaults to Fahrenheit unless changed by the user.

Model LRGL5825*

- 1 Press **Settings** repeatedly until **Unit** appears in the display.
- 2 Press **1** to select **F** (Fahrenheit) or **C** (Celsius).
- 3 Press **Start** to accept the change.

Model LRGL5823* / LRGL5821*



- 1 **Model LRGL5823***
Press and hold the **Clock** button for 3 seconds. Press **Clock** repeatedly until **Unit** appears in the display.

Model LRGL5821*
Press **Settings** repeatedly until **Unit** appears in the display.
- 2 Press **+/-** to select **F** (Fahrenheit) or **C** (Celsius).
- 3 Press **Start** to accept the change.

Lockout (Model LRGL5825*/LRGL5823*)

Door lockout feature is not available in model **LRGL5821***, instead of it the available function for lockout its only for locking control.

The Lockout feature automatically locks the oven door and prevents most oven controls from being turned on. It does not disable the timer and the interior oven light.

- 1 Press and hold **Clear/Off** for three seconds.
- 2 The lock melody sounds, **Loc** appears in the display (available on some models) and the lock  blinks in the display.
- 3 Once the oven door is locked, the lock  indicator stops blinking and remains on.
- 4 To deactivate the Lockout feature, press and hold **Clear/Off** for three seconds. The unlock melody sounds and the door and the controls unlock.

NOTE

In models without a self-clean mode, the Lockout feature locks the controls but not the oven door. The lock  indicator does not blink.

Cook Time (Timed Cook)

Set the oven to cook for a specific length of time using the Timed Cook feature. This feature can only be used with the **Bake**, **Conv. Bake**, **Conv. Roast**, **Frozen Meal**, **Slow Cook** and **Favorite Cook** modes.

Setting the Cook Time Function

For example, to bake at 300 °F for 30 minutes, first set the clock to the correct time of day.

Model LRGL5825*

- 1 Press **Bake**. 350 °F appears in the display.
- 2 Set the temperature. Press **3**, **0** and **0**.
- 3 Press **Cook Time**. **Timed** flashes in the display. **Bake**, 300 °F and 0:00 appear in the display.
- 4 Set the baking time:
Press **3** and **0**.
The baking time can be set for any amount of time between 1 minute and 11 hours and 59 minutes.
- 5 Press **START**.

Model LRGL5823* / LRGL5821*

- 1 Press **Bake**. 350 °F appears in the display.
- 2 Set the temperature. Press **+/-** button.
- 3 Press **Cook Time**. **Timed** flashes in the display. **Bake**, 0:00 appear in the display.
- 4 Set the baking time:
Press **+/-** button to set the baking time.
The baking time can be set for any amount of time between 1 minute and 11 hours and 59 minutes.
- 5 Press **START**.

The oven will continue to cook for the set amount of time and then turn off automatically. When the cooking time has elapsed:

- **End** and the time of day show in the display.
- The cook end indicator **tone sounds every 60 seconds until Clear/Off** is pressed.

Changing the Cook Time during Cooking

For example, to change the cook time from 30 minutes to 1 hour and 30 minutes, do the following.

Model LRGL5825*

- 1 Press **Cook Time**.
- 2 Change the baking time: Press **1**, **3** and **0**.
- 3 Press **START** to accept the change.

Model LRGL5823* / LRGL5821*

- 1 Press **Cook Time**.
- 2 Change the baking time: Press **+/-** button.
- 3 Press **START** to accept the change.

Start Time (Delayed Timed Cook)

The automatic timer of the Delayed Timed Cook function turns the oven on and off at the time you select. This feature can be used with the **Bake**, **Conv. Bake**, **Conv. Roast** and **Self-Cleaning** modes.

Setting a Delayed Timed Cook

For example, to bake at 300 °F for 30 minutes and delay the start of baking until 4:30, first set the clock to the correct time of day.

Model LRGL5825*

- 1 Press **Bake**. 350 °F appears in the display.
- 2 Set the temperature: press **3**, **0** and **0**.
- 3 Press **Cook Time** and press the number keys to set the baking time: press **3** and **0**.
- 4 Press **Start Time**.
- 5 Set the start time: press **4**, **3** and **0** for 4:30.
- 6 Press **Start**. A short beep sounds, **Timed Delay** and the start time appear in the display. The oven begins baking at the set start time.

Model LRGL5823* / LRGL5821*

- 1 Press **Bake**. 350 °F appears in the display.
- 2 Set the temperature:
Press or press and hold the **+/-** buttons until the desired temperature appears in the display.
- 3 Press **Cook Time** and press **+/-** keys to set the baking time.
- 4 Press **Start Time**.
- 5 Set the start time:
Use the **+/-** buttons to adjust the time displayed to match your desired start time.
- 6 Press **Start**. A short beep sounds, **Timed Delay** and the start time appear in the display. The oven begins baking at the set start time.

NOTE

- To cancel the Delayed Timed Cook function, press **Clear/Off** at any time.
- To change the cooking time, repeat step 3 and press **Start**.
- If the oven clock is set as a 12-hour clock, you can delay the cook time for 12 hours. If the oven clock is set as a 24-hour clock, you can delay the cook time for 24 hours.

The oven will continue to cook for the set amount of time and then turn off automatically. When the cooking time has elapsed:

- **End** and the time of day show in the display.
- The cook end indicator tone sounds every 60 seconds until **Clear/Off** is pressed.
- When **Warm** is set, the warming function is activated after the cooking time ends.

CAUTION

- Use the automatic timer when cooking cured or frozen meats and most fruits and vegetables. Foods that can easily spoil, such as milk, eggs, fish, meat or poultry, should be chilled in the refrigerator. Even when chilled, they should not stand in the oven for more than 1 hour before cooking begins, and should be removed promptly when cooking is completed.
- Eating spoiled food can result in sickness from food poisoning.

InstaView™ (Only Model LRGL5825*)

This feature is not available in model LRGL5823*/LRGL5821*.

Knock twice on the center of the glass panel to reveal the contents of the oven without opening the door.

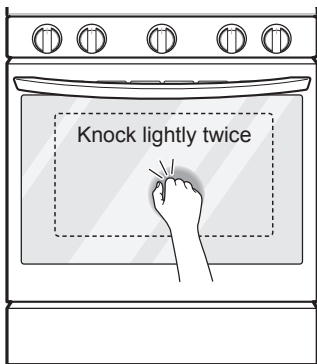

Model	InstaView™
LRGL5825	Available
LRGL5823	Not available
LRGL5821	Not available

- Knocking twice on the glass panel turns the interior light on or off.
- The light turns off automatically after 90 seconds.
- The InstaView™ function is disabled when the oven door is opened and for one seconds after closing the door.
- The InstaView™ function is disabled during Self Clean, Lockout, and initial power input.

WARNING

Do not hit the glass door panel with excessive force. Do not allow hard objects like cookware or glass bottles to hit the glass door panel. The glass could break, resulting in a risk of personal injury or product damage.

NOTE

- Tapping the edges of the glass panel may not activate the InstaView™ function.
- The taps on the glass panel must be hard enough to be audible.
- Loud noises near the oven may activate the InstaView™ function.

Removing and Replacing the Oven Racks**CAUTION**

- Replace the oven racks before turning the oven on to prevent burns.
- Do not cover the racks with aluminum foil, or any other material, or place anything on the bottom of the oven. Doing so will result in poor baking performance and may damage the oven bottom.
- Only arrange oven racks when the oven is cool.

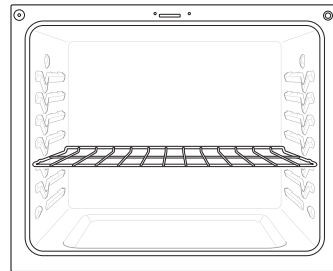
**Removing Racks**

- 1 While wearing oven mitts, grasp the oven rack*.
- 2 Pull the rack straight out until it stops.
- 3 Lift up the front of the rack.
- 4 Pull out the rack.

* When possible, adjust oven racks before using the oven. Always wear oven mitts if adjusting racks while the oven is on.

Replacing Racks

- 1 While wearing oven mitts, place the end of the rack on the support*.
- 2 Tilt the front end of the rack up.
- 3 Push the rack in.
- 4 Check that the rack is properly in place.

*When possible, adjust oven racks before using the oven. Always wear oven mitts if adjusting racks while the oven is on.

Recommended Baking and Roasting Guide

- Center pans on racks for best baking results. If baking with more than one pan, place the pans so that each one has at least 1" to 1½" of air space around it. Do not allow pans to touch the walls of the oven.
- If cooking on a single rack, place the standard rack in the position suggested in the charts on the following pages. Center the cookware as shown in the single rack baking image.
- If cooking on multiple racks in the oven, place standard racks in positions 2 and 5. For best results, place the cookware as shown. (Place standard racks in positions 3 and 5. **Model LRGL5821***)

Multiple Rack Baking

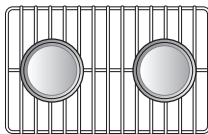

Standard rack
(Position 2)

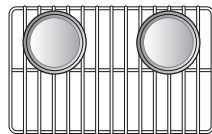

Standard rack
(Position 5)

Single Rack Baking

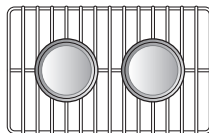

Standard rack

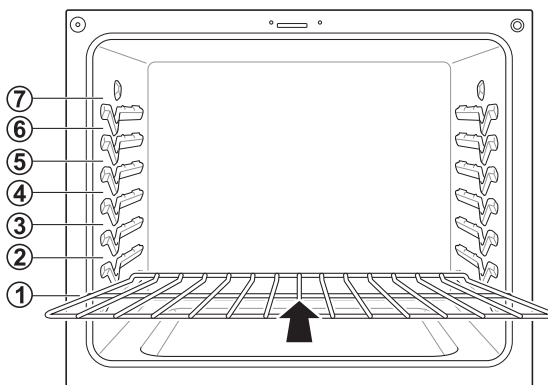

Bake

Bake is used to prepare foods such as pastries, breads and casseroles. The oven can be programmed to bake at any temperature from 170 °F (80 °C) to 550 °F (285 °C). The default temperature is 350 °F (175 °C).

- Press **Bake**. 350° appears in the display and BAKE flashes.
- Model LRGL5825***
Press the **number** buttons to enter the desired oven temperature.

Model LRGL5823* / LRGL5821*
Press or press and hold the **+/-** buttons until the desired temperature appears in the display.
- Press **Start** to accept the temperature change. As the oven preheats, the temperature is displayed and rises in 5-degree increments. Once the oven reaches the set temperature, a tone sounds and the oven light blinks on and off.
- When cooking is complete, press **Clear/Off**.
- Remove food from the oven.

Changing the Temperature while Cooking

- Press **Bake**.
- Model LRGL5825***
Press the **number** buttons to enter the new temperature.

Model LRGL5823* / LRGL5821*

Press or press and hold the **+/-** buttons until the desired temperature appears in the display.

- Press **Start**.

NOTE

If the door is opened during baking, the bake burner turns off after 30 seconds. The burner turns back on automatically once the door is closed.

Convection Mode (Model LRGL5825* / LRGL5823*)

The convection system uses a fan to circulate the heat evenly within the oven. Improved heat distribution allows for even cooking and excellent results while cooking with single or multiple racks.

Setting the Convection Function (example, 375 °F)

- Press **Conv. Bake** or **Conv. Roast**. The display flashes 350 °F.

- 2 Set the oven temperature:
Model LRGL5825*
 Press **3**, **7** and **5**.
Model LRGL5823*
 Using the **+/-** key set the temperature.
- 3 Press **START**. The display shows **Conv. Bake** or **Conv. Roast** and the oven temperature starting at 100 °F.

As the oven preheats, the display shows increasing temperatures in 5-degree increments. Once the oven reaches the set adjusted temperature, a tone sounds and the oven light flashes on and off. The display shows the auto converted oven temperature, 350 °F and the fan icon.

- 4 When cooking has finished or to cancel, press **Clear/Off**.

NOTE

- The oven fan runs while convection baking. The fan stops when the door is open. In some cases, the fan may shut off during a convection bake cycle.
- It's normal that convection fan is not turning on directly. The fan will turn on later.

Tips for Convection Baking

- Use Convection Bake for faster and more even multiple-rack cooking of pastries, cookies, muffins, biscuits, and breads of all kinds.
- Bake cookies and biscuits on pans with no sides or very low sides to allow heated air to circulate around the food. Food baked on pans with a dark finish will cook faster.
- When using Convection Bake with a single rack, place the oven rack in position 4. If cooking on multiple racks, place the oven racks in positions 2(or 3) and 5 for two racks.
- Multiple oven rack cooking may slightly increase cook times for some foods.
- You will have better results when baking cakes, cookies and muffins using multiple racks.

The Convection Roast feature is designed to give optimum roasting performance. Convection Roast combines cooking with the convection fan to roast meats and poultry. The heated air circulates around the food from all sides, sealing in juices and flavors. Foods are crispy brown on the outside while staying moist on the inside. Convection roasting is especially good for large tender cuts of meat, uncovered.

Tips for Convection Roasting

Use a broiler pan and grid when preparing meats for convection roasting. The broiler pan catches grease spills and the grid helps prevent grease splatters.

- 1 Place the oven rack on the bottom.
- 2 Place the grid in the broiler pan.
- 3 Place the broiler pan on the oven rack.

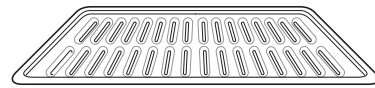

Grid (sold separately)

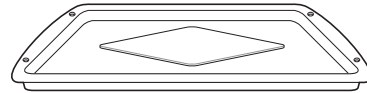

Broiler pan (sold separately)

CAUTION

- Do not use a broiler pan without a grid.
- Do not cover the grid with aluminum foil.
- Position food (fat side up) on the grid.

Baking Chart

This chart is only for reference. Adjust the cook time according to the recipe.

Type of Food	Rack Position
Frozen pies (on cookie sheet)	2 or 3
Angel food cake, bundt or pound cakes	3
Biscuits, muffins, brownies, cookies, cupcakes, layer cakes, pies	4
Casseroles	4
Roasting	1 or 2
Fresh/frozen pizza	3

Roasting rack guide

	Food	Rack position	
Beef	Rib	Rare	2
		Medium	2
		Well done	2
	Boneless rib, top sirloin	Rare	2
		Medium	2
		Well done	2
Beef tenderloin	Rare	2	
	Medium	2	
Pork	Rib	2	
	Bone-in, sirloin	2	
	Ham, cooked	2	
Poultry	Whole chicken	2	
	Chicken pieces	2	
	Turkey	2	

Broil

The oven is designed for closed-door broiling. Broil uses the intense radiant heat from the upper gas burner.

The Broil function works best when broiling thin, tender cuts of meat (1" or less), poultry or fish.

CAUTION

- Do not use a broiler pan without a grid. The oil can cause a grease fire.
- Do not cover the grid and broiler pan with aluminum foil. Doing so will cause a fire.
- Always use a broiler pan and grid for excess fat and grease drainage. This will help to reduce splatter, smoke, and flare-ups.
- Never use a broiler pan that is not thoroughly cleaned and at room temperature. If your broiler pan is damaged, warped, or has heavy permanent soiling, consider replacing it to reduce the amount of smoke experienced during broiling.

NOTE

- Use Lo broil to broil foods such as poultry and thick cuts of meat.
- Remove the pan from the oven to cool down for easy cleaning.
- For best results, use a pan designed for broiling, as shown below. The broiler pan will catch grease spills and the grid will help prevent grease splatters.

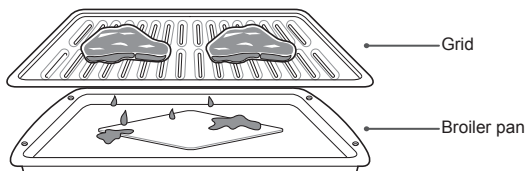

When broiling refer to the broiling guide for placing the rack.

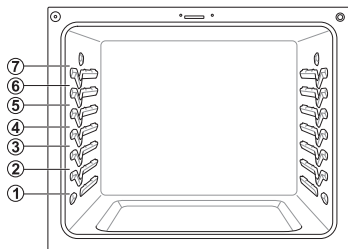

Setting the Oven to Broil

- 1 Press **Broil** once for Hi and twice for Lo.
- 2 Press **Start**.
- 3 Allow the broiler to preheat for five minutes.
- 4 Place food in the oven.
- 5 Close the oven door. The oven door must be closed during broiling.

WARNING

When using the broiler, the temperature inside the oven is extremely hot. Use caution and avoid possible burns by:

- Keeping the door closed when broiling
- Always wearing oven mitts when inserting/removing food items

Improper use of the broiler may result in excessive smoke or a grease fire. Improper use conditions include, but are not limited to:

- Setting the broiler to a higher power level than recommended.
- Using dirty/greasy broiler pans.
- Broiling beyond recommended cooking times.

NOTE

This range is designed for closed-door broiling. Close the door to set the Broil function. If the door is open, the Broil function cannot be set and **door** appears on the display. Close the door and reset the Broil function. Opening the door turns off the broil burner during broiling.

If the door is opened during broiling, the broil burner turns off after 5 seconds. The broiler turns back on automatically once the door is closed.

- 6 When broiling is finished, press **Clear/Off**.

NOTE

During any Broil function, it is normal for the broiler to cycle on and off. The igniter for the broil burner on the ceiling of the oven glows orange periodically during normal broil operation.

Recommended Broiling Guide

The size, weight, thickness, starting temperature, and preference of doneness will affect broiling times. This guide is based on meats at refrigerator temperature. For best results when broiling, use a pan designed for broiling.

Food	Quantity and/or Thickness	Rack Position	First Side (minutes)	Second Side (minutes)	Comments
Ground Beef	1 lb. (4 patties) 1/2 to 3/4" thick	6	4-6	3-5	Space evenly. Up to 9 patties may be broiled at once.
Beef Steaks					Steaks less than 1" thick cook through before browning. Pan frying is recommended. Slash fat.
Rare	1" thick 1 to 1 1/2 lbs.	6	7	5	
Medium		6	12	5-6	
Well Done		6	13	8-9	
Rare	1 1/2" thick 2 to 2 1/2 lbs.	4	10	6-7	
Medium		4	12-15	10-12	
Well Done		4	25	16-18	
Toast	1 to 9 pieces	5	1-2	1-2	
Chicken	1 whole 2 to 2 1/2 lbs., split lengthwise 4 bone-in breasts	2	35-40	25	Brush each side with melted butter. Broil skin-side down.
		2	25-30	10-15	
Fish Fillets	1/4 to 1/2" thick	5	7-8	6	Handle and turn very carefully. Brush with lemon butter before and during cooking, if desired.
Ham Slices (precooked)	1" thick 1/2" thick	3	10	5	Increase time 5 to 10 minutes per side for 1 1/2" thick or home-cured ham.
		4	7	4	
Pork chops	2 (1/2" thick)	4	10	8	Slash fat.
Well Done	2 (1" thick) about 1lb.	4	13	8-9	
Lamb Chops					Slash fat.
Medium	2 (1" thick) about 10 to 12 oz.	5	6	4-7	
Well Done		5	10	10	
Medium	2 (1/2" thick) about 1lb.	5	10	4-6	
Well done		5	17	12-14	
Bacon	1/2 lb. (about 8 thin slices)	4	8	3	Arrange in single layer.
Lobster Tails	2-4 6 to 8 oz. each	3	13-16	Do not turn over.	Cut through back of shell. Spread open. Brush with melted butter before broiling and after half of broiling time.

- This guide is only for reference. Adjust cook time according to preference.

NOTE

The USDA advises that consuming raw or undercooked fish, meat, or poultry can increase the risk of food-borne illness.

The USDA has indicated the following as safe minimum internal temperatures for consumption:

- Ground meat : 160 °F (71.1 °C)
- Poultry: 165 °F (73.9 °C)
- Beef, veal, pork, or lamb: 145 °F (62.8 °C)
- Fish / Seafood: 145 °F (62.8 °C)

Sabbath Mode

Sabbath mode is typically used on the Jewish Sabbath and Holidays. When the SABBATH mode is activated, the oven does not turn off until the SABBATH mode is deactivated. In SABBATH mode, all function buttons, except for the CLEAR/OFF are inactive. Sb will appear in both the cooktop and oven displays.

NOTE

- If the oven light is turned ON and the SABBATH mode is active, the oven light will turn OFF. If the oven light needs to be OFF, be sure to turn the oven light OFF before activating the SABBATH mode. SABBATH mode can only be used in Bake mode.

Setting the Sabbath mode

- 1 Press the **Bake** button.
- 2 Set the Bake temperature
Model LRGL5825*
 Use the number buttons.
Model LRGL5823* / LRGL5821*
 Use the +/- buttons.
- 3 Press the **START** button.
- 4 **Model LRGL5825* / LRGL5821***
 Press and hold the **Settings** button for three seconds.
Model LRGL5823*
 Press and hold the **Clock** button for three seconds.

NOTE

Sb and will appear in the display when the Sabbath mode is activated (Model LRGL5825*).

Sb will appear in the display when the Sabbath mode is activated (Model LRGL5823*/LRGL5821*).

- 5 To cancel the Sabbath mode, press and hold the **Settings** or **Clock** button for three seconds. To cancel the Bake function, press the **CLEAR/OFF** button at any time.

Changing the temperature while in Sabbath mode

- 1 Press the **Bake** button. (No tones will sound and the display will not change.)
- 2 Set the Bake temperature
Model LRGL5825*
 Use the number buttons.
Model LRGL5823* / LRGL5821*
 Use the +/- buttons.
- 3 Press the **START** button.

NOTE

- There is a 15 second delay before the oven will recognize the temperature change.

Favorite (Only Model LRGL5825*)

This feature is not available in model **LRGL5823*/LRGL5821***.

The FAVORITE feature is used to record and recall favorite recipe settings. This feature can store and recall up to 3 different settings. The Favorite feature can be used with the Cook Time mode. It will not work with any other function including the Start Time (delayed cook) mode.

- 1 Place the food in the oven.
- 2 Press **FAVORITE** once for Bread, twice for Meat, and 3 times for Chicken. The default temperature appears and **COOK** flashes.

Category	How to Select	Default Temp. (may be changed and recalled)	Operating Feature
1. Bread	Press FAVORITE once.	375 °F	BAKE
2. Meat	Press FAVORITE twice.	325 °F	Convection Roast
3. Chicken	Press FAVORITE 3 times.	350 °F	Convection Roast

- 3 Press the **number buttons** to set the desired oven temperature. This temperature is stored and recalled when next used.
- 4 Press **START**. The preheat indicator beeps 1 time and lamps 5 times when the oven reaches the set temperature.

NOTE

- Only the selected temperature is stored, not the cooking time.
- If the oven temperature is changed, the changed temperature is stored.

Wi-Fi (Model LRGL5825*/LRGL5823*/LRGL5821*)

Connect the appliance to a home Wi-Fi network to use Remote Start and other smart functions. See the Smart Functions section for more details.

Setting Up Wi-Fi

- 1 Press and hold **Remote Start** until the icon blinks.
- 2 Follow the instructions in the LG ThinQ app to connect the appliance.

Remote Start (Model LRGL5825*/LRGL5823*/LRGL5821*)

Remotely starts or stops the preheating function of the appliance. The appliance must be connected to a home Wi-Fi network to use Remote Start.

Setting Remote Start

- 1 Open the oven door and make sure that the oven is empty.
- 2 Press the **Remote Start** button to enable the function.
- 3 Start the preheat function on the oven from the LG ThinQ app.

Frozen Meal (Only Model LRGL5825*)

This feature is not available in model LRGL5823*/LRGL5821*.

The Frozen Meal function is specially designed for cooking frozen prepared meals. It heats from both the top and bottom to brown food more evenly.

This system is designed to give the optimum cooking performance by automatically selecting a combination of the broil and bake heating systems. No preheating is required when using the Frozen Meal mode. For best results with frozen pizza, cook on a single rack in position 5 at 400 °F.

Setting the Frozen Meal Function

- 1 Press **Frozen Meal**. Frozen appears in the display.
- 2 Enter the cook temperature using the **number buttons**.
- 3 Press **Start**. The Frozen Meal function starts operation.
- 4 Press **Clear/Off** to cancel Frozen Meal at any time.

Slow Cook (Only Model LRGL5825*)

This feature is not available in model LRGL5823*/LRGL5821*.

The Slow Cook function is specially designed for cooking grilled beef, pork, and poultry dishes.

It is common for the surface of the food to darken after the completion of the Slow Cook. No preheating is required when using the **Slow Cook** mode.

Setting the Slow Cook Function

- 1 Press **Slow Cook** once. Hi appears in the display. Press **Slow Cook** repeatedly to toggle between Hi and Lo. Select the desired option.
- 2 Press **Start**. The Slow Cook function starts operation.
- 3 Press **Clear/Off** to cancel Slow Cook at any time.

NOTE

- For best results, use a single rack in position 1 or 2.
- Hi: 312 °F (156 °C), Lo: 260 °F (127 °C)
(Temperatures measured in empty oven. Actual temperatures depend on type and amount of food in oven.)

Warm / Keep Warm

This function will maintain an oven temperature of 170 °F. The Warm function will keep cooked food warm for serving up to three hours after cooking has finished. The Warm function may be used without any other cooking operations.

The Warm function can be used after cooking has finished using a Timed Cook or a Delayed Timed Cook.(Model LRGL5825*)

Setting the Warm Function (Model LRGL5823*/LRGL5821*)

- 1 Press **Warm** or **Air fry/Warm** once for Model LRGL5821* and twice for Model LRGL5823*.
- 2 Press **Start**.
- 3 Press **Clear/Off** at any time to cancel.

Setting the Warm Function after a Timed Cook (Model LRGL5825*)

- 1 Select the cooking function.
- 2 Enter the oven temperature using the number keys or the +/- keys.
- 3 Press **Cook Time** and enter the cook time using the number keys.
- 4 Press **Warm** or **Keep Warm**.
- 5 Press **Start**.
- 6 When cooking is finished, press **Clear/Off** to cancel the Warm function.

NOTE

- The Warm function is intended to keep food warm. Do not use it to cool food down.
- It is normal for the fan to operate during the Warm function.

Proof (Only Model LRGL5825*)

This feature is not available in model LRGL5823*/LRGL5821*.

This feature maintains a warm oven for rising yeast leavened products before baking.

For best proof performance, cover the food with foil.

Setting the Proof Function

- 1 Use rack position 2 or 3 for proofing.
- 2 Press **Proof** until **Proof** appears in the display.
- 3 Press **Start**.
- 4 Press **Clear/Off** when proofing is finished.

NOTE

- To avoid lowering the oven temperature and lengthening proofing time, do not open the oven door unnecessarily. Check bread products early to avoid over proofing.
- Do not use the proofing mode for warming food or keeping food hot. The proofing oven temperature is not hot enough to keep foods at safe temperatures. Use the Warm feature to keep food warm. Proofing does not operate when the oven is above 125 °F. **Hot** shows in the display.

Air Fry (Only Model LRGL5825* / LRGL5823*)

This feature is not available in model **LRGL5821***.

This Feature automatically increases the entered temperature by 60 °F for optimal performance when using Air Fry. The function is specially designed for oil-free frying.

- No preheating is required when using the Air Fry mode.
- For best results, cook food on a single rack placed in position 3 or 4.
- Spread the food out evenly in a single layer.
- Use either the optional Air Fry Tray available from LG or a dark broiler pan with no sides or short sides that does not cover the entire oven rack. This allows for better air circulation.
- If desired, spray the broiler pan or Air Fry tray with a pan spray. Use an oil that can be heated to a high temperature before smoking, such as avocado, grapeseed, peanut or sunflower oil.
- Place a foil-lined broiler pan on a rack in position 2 to catch the oil falling from the food. For high-fat foods like chicken wings, add a few sheets of parchment paper to absorb the fat.
- Check food often and shake it or turn it over for crisper results.
- Prepared frozen foods may cook faster with the Air Fry mode than stated on the package. Reduce the cooking time by about 20 percent, check food early, and adjust cooking time as needed.
- If cooking multiple batches, the later batches may take less time to cook.
- Use a food thermometer to make sure food has reached a safe temperature for consumption. Eating undercooked meats can increase your risk of food-borne illness.
- Wet batters and coating will not crisp or set when using the Air Fry mode.
- For the crispiest results, dredge fresh chicken wings or tenders in seasoned flour. Use 1/3 cup flour for 2 pounds.

Air Frying High-Fat Foods

Foods high in fat will smoke when using the Air Fry mode. For best results, follow these recommendations when air frying foods that are high in fat, such as chicken wings, bacon, sausage, hot dogs, turkey legs, lamb chops, ribs, pork loin, duck breasts, or some plant-based proteins.

CAUTION

Never cover slots, holes, or passages in the oven bottom or cover entire racks with materials such as aluminum foil. Doing so blocks airflow through the oven and can result in carbon monoxide poisoning. Aluminum foil can also trap heat, causing a fire hazard or poor oven performance.

- Turn on your exhaust hood at a high fan setting before you start Air Fry and leave it on for 15 minutes after you're done.
- Open a window or sliding glass door, if possible, to make sure the kitchen is well-ventilated.
- Clean the grease filters on your exhaust hood regularly.
- Keep the oven free from grease buildup. Wipe down the interior of the oven before and after air frying (once the oven has cooled).
- Run oven cleaning cycles (Easy Clean™ or Self Clean) regularly, depending on how often and what types of food you Air Fry.
- Avoid opening the oven door more than necessary to help maintain the oven temperature, prevent heat loss, and save energy.
- Air-frying fresh chicken pieces such as wings or drumsticks with the skin left on can produce smoke as the fat renders at high temperatures. If the smoke is excessive, use the Convection Roast mode instead of Air Fry.

Setting the Air Fry Function

- 1 Press **Air Fry**. 400 °F appears in the display.
- 2 Set the oven temperature (Range:300°F~550°F)
Model LRGL5825*
 Press the number buttons to enter the desired temperature.
Model LRGL5823*
 Use the +/- buttons to set the desired temperature.
- 3 Press **START**.
- 4 When cooking is complete, press **Clear/Off**.

NOTE

- The Air Fry function can be used with a wire rack inside a foil-lined broiler pan.
- For best results, use the air fry tray sold separately at www.lg.com and use a foil-lined broiler pan below it as a drip pan.
- Do not clean the air fry Tray in the dishwasher.

Air fry tray

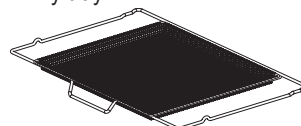

Broiler Pan



Air Fry Cook Guide

- Air Fry Tray

- Arrange food evenly in a single layer.
- Put a foil-lined broiler pan on a rack in position 2 to catch drips. If needed, add parchment paper to absorb oil and reduce smoking.
- Flip food over during cooking to avoid burning it.

* High-fat items may produce more smoke when cooked using Air Fry. For less smoke, cook using Convection Roast mode.

Recommended Items	Approx. Quantity (oz)	Temp (°F)	Rack Position	Time (min)	Guide
POTATOES - Frozen					
French Fries	20	400	4	15-25	
Crinkle Cut Fries 3/8" (10 mm)	35	400	4	20-30	
Sweet Potato Fries	25	400	4	15-30	
Tater Tots	50	450	4	15-25	
Hash Browns	40	450	4	23-33	
POTATOES - Fresh/Homemade					
French Fries 3/8" (10 mm)	25	450	4	30-40	Cut the potatoes and soak for 30 minutes in hot tap water. Drain and pat dry. Brush or lightly spray with 3 tbsp. of oil. Add salt and pepper to taste.
Potato Wedges	60	450	4	30-40	
CHICKEN - Frozen					
Crispy Chicken Nuggets	30	450	4	13-24	
Chicken Strips	35	450	4	22-32	
Hot Wings, Bone-in	50	450	4	25-35	
CHICKEN - Fresh, Skin on*					
Wings	40	450	4	20-30	Brush or lightly spray with 3 tbsp. of oil. Add salt and pepper to taste.
Drumsticks	70	450	4	35-45	
Thighs	40	450	4	30-35	*High-fat items may produce more smoke when cooked using Air Fry. For less smoke, cook using Convection Roast mode.
Breasts	40	450	4	30-35	
OTHER					
Onion Rings - Frozen, Breaded	20	425	4	12-23	
Spring Rolls (0.7 oz/20 g each) - Frozen	50	425	4	18-28	
Thin Sausage* - 2.5 oz each, 3/4" diam. (70 g each, 2 cm diam.)	90	425	4	20-30	*High-fat items may produce more smoke when cooked using Air Fry. For less smoke, cook using Convection Roast mode.
Coconut Shrimp - Frozen	25	400	4	20-30	Brush or lightly spray the surface of food with oil.
Scallops on Half Shell - Fresh	35	425	4	20-30	Melt 4 tbsp. of butter and brush on scallops. Mix 1/2 cup bread crumbs, 1 tbsp. minced garlic, 1/4 cup grated parmesan cheese and season to taste. Sprinkle mixture over scallops.
Shrimp - Fresh	50	425	4	20-30	
Mixed Vegetables	35	425	4	15-25	Brush or lightly spray with 4 tbsp. of olive oil. Add salt and pepper to taste.

40 OPERATION

Air Fry Cook Guide

- Dark Nonstick Baking Pan



- Arrange food evenly in a single layer.
- Use a dark, nonstick baking pan on a rack in position 4.
- Flip food over during cooking to avoid burning it.

* High-fat items may produce more smoke when cooked using Air Fry. For less smoke, cook using Convection Roast mode.

Recommended Items	Approx. Quantity (oz)	Temp (°F)	Rack Position	Time (min)		Guide
				1st Side	2nd Side	
POTATOES - Frozen						
French Fries	20	400	4	19-26	–	
Crinkle Cut Fries 3/8" (10 mm)	35	400	4	19-25	5–11	
Sweet Potato Fries	25	400	4	19-26	5–11	
Tater Tots	50	450	4	13-19	5–11	
Hash Browns	40	450	4	14-20	4–10	
POTATOES - Fresh/Homemade						
French Fries 3/8" (10 mm)	25	450	4	16-22	8–14	Cut the potatoes and soak for 30 minutes in hot tap water. Drain and pat dry. Brush or lightly spray with 3 tbsp. of oil. Add salt and pepper to taste.
Potato Wedges	60	450	4	16-22	8–14	
CHICKEN - Frozen						
Crispy Chicken Nuggets	30	450	4	12–18	2–8	
Chicken Strips	35	450	4	13-19	2–9	
Hot Wings, Bone-in	50	450	4	14-20	5–11	
CHICKEN - Fresh, Skin on*						
Wings	40	450	4	18-25	5–12	Brush or lightly spray with 3 tbsp. of oil. Add salt and pepper to taste.
Drumsticks	70	450	4	35-45	–	
Thighs	40	450	4	30-35	5–12	*High-fat items may produce more smoke when cooked using Air Fry. For less smoke, cook using Convection Roast mode.
Breasts	40	450	4	30-35	5–12	
OTHER						
Onion Rings - Frozen, Breaded	20	425	4	10–16	2–8	
Spring Rolls (0.7 oz/20 g each) - Frozen	50	425	4	12–18	3–9	
Thin Sausage* - 2.5 oz each, 3/4" diam. (70 g each, 2 cm diam.)	90	425	4	11–18	1–7	*High-fat items may produce more smoke when cooked using Air Fry. For less smoke, cook using Convection Roast mode.
Coconut Shrimp - Frozen	25	400	4	10–16	10–16	Brush or lightly spray the surface of food with oil.
Scallops on Half Shell - Fresh	35	425	3	20-30	–	Melt 4 tbsp. of butter and brush on scallops. Mix 1/2 cup bread crumbs, 1 tbsp. minced garlic, 1/4 cup grated parmesan cheese and season to taste. Sprinkle mixture over scallops.
Shrimp - Fresh	50	425	4	20-30	–	

SMART FUNCTIONS

LG ThinQ Application

This feature is only available on models with the  or  logo.

The **LG ThinQ** application allows you to communicate with the appliance using a smartphone.

LG ThinQ Application Features

Smart Diagnosis™

This function provides useful information for diagnosing and solving issues with the appliance based on the pattern of use.

Settings

Allows you to set various options on the oven and in the application.

Monitoring

This function shows the current status, remaining cook time, and cook settings on one screen.

Push Alerts

Turn on the Push Alerts to receive appliance status notifications. The notifications are triggered even if the LG ThinQ application is off.

Timer

You can set the timer from the app.

Firmware Update

Keep the appliance updated.

Remote Start

Control the appliance remotely or check the remaining cook time from the LG ThinQ application.

NOTE

- If you change your wireless router, Internet service provider, or password, delete the registered appliance from the **LG ThinQ** application and register it again.
- This information is current at the time of publication. The application is subject to change for product improvement purposes without notice to users.
- This feature is only available on some models.

Before Using LG ThinQ Application

- 1 Use a smartphone to check the strength of the wireless router (Wi-Fi network) near the appliance.
 - If the distance between the appliance and the wireless router is too far, the signal becomes weak. It takes long time to register or fails to install the application.
- 2 Turn off the **Mobile data** or **Cellular Data** on your smartphone.

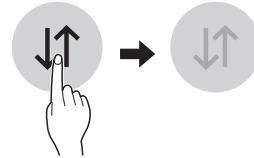

- 3 Connect your smartphone to the wireless router.

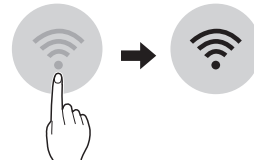

NOTE

- To verify the Wi-Fi connection, check that **Wi-Fi**  icon on the control panel is lit.
- The appliance supports 2.4 GHz Wi-Fi networks only. To check your network frequency, contact your Internet service provider or refer to your wireless router manual.
- **LG ThinQ** is not responsible for any network connection problems or any faults, malfunctions, or errors caused by network connection.
- The surrounding wireless environment can make the wireless network service run slowly.
- If the appliance is having trouble connecting to the Wi-Fi network, it may be too far from the router. Purchase a Wi-Fi repeater (range extender) to improve the Wi-Fi signal strength.
- The network connection may not work properly depending on the Internet service provider.
- The Wi-Fi connection may not connect or may be interrupted because of the home network environment.
- If the appliance cannot be registered due to problems with the wireless signal transmission, unplug the appliance and wait about a minute before trying again.
- If the firewall on your wireless router is enabled, disable the firewall or add an exception to it.

NOTE

- The wireless network name (SSID) should be a combination of English letters and numbers. (Do not use special characters.)
- Smartphone user interface (UI) may vary depending on the mobile operating system (OS) and the manufacturer.
- If the security protocol of the router is set to **WEP**, network setup may fail. Change the security protocol (**WPA2** is recommended), and register the product again.

Installing the LG ThinQ Application

Search for the **LG ThinQ** application from the Google Play Store or Apple App Store on a smartphone. Follow instructions to download and install the application.

Open Source Software Notice Information

To obtain the source code under GPL, LGPL, MPL and other open source licenses, that is contained in this product, please visit <http://opensource.lge.com>. In addition to the source code, all referred license terms, warranty disclaimers and copyright notices are available for download.

LG Electronics will also provide open source code to you on CD-ROM for a charge covering the cost of performing such distribution (such as the cost of media, shipping, and handling) upon email request to opensource@lge.com. This offer is valid for three (3) years from the date on which you purchased the product.

Wireless LAN Module Specifications

Frequency Range	2412 MHz - 2462 MHz
Output Power(max)	< 30 dBm

FCC Notice

The following notice covers the transmitter module contained in this product. This equipment has been tested and found to comply with the limits for a Class B digital device, pursuant to Part 15 of the FCC Rules. These limits are designed to provide reasonable protection against harmful interference in a residential installation. This equipment generates, uses, and can radiate radio frequency energy and, if not installed and used in accordance with the instructions, may cause harmful interference to radio communications. However, there is no guarantee that interference will not occur in a particular installation. If this equipment does cause harmful interference to radio or television reception, which can be determined by turning the equipment off and on, the user is encouraged to try to correct the interference by one or more of the following measures:

- Reorient or relocate the receiving antenna.
- Increase the separation between the equipment and the receiver.
- Connect the equipment into an outlet on a circuit different from that to which the receiver is connected.
- Consult the dealer or an experienced radio/TV technician for help.

This device complies with Part 15 of the FCC Rules. Operation is subject to the following two conditions:

- 1) This device may not cause harmful interference and
- 2) This device must accept any interference received, including interference that may cause undesired operation.



Any changes or modifications in construction of this device which are not expressly approved by the party responsible for compliance could void the user's authority to operate the equipment.

FCC RF Radiation Exposure Statement

This equipment complies with FCC radiation exposure limits set forth for an uncontrolled environment. This transmitter must not be co-located or operating in conjunction with any other antenna or transmitter.

This equipment should be installed and operated with a minimum distance of 20 cm (7.8 inches) between the antenna and your body. Users must follow the specific operating instructions for satisfying RF exposure compliance.

Smart Diagnosis™ Feature

This feature is only available on models with the  or  icon.

Use this feature to help you diagnose and solve problems with your appliance.

NOTE

- For reasons not attributable to LGE's negligence, the service may not operate due to external factors such as, but not limited to, Wi-Fi unavailability, Wi-Fi disconnection, local app store policy, or app unavailability.
- The feature may be subject to change without prior notice and may have a different form depending on where you are located.

Using LG ThinQ to Diagnose Issues

If you experience a problem with your Wi-Fi equipped appliance, it can transmit troubleshooting data to a smartphone using the **LG ThinQ** application.

- Launch the **LG ThinQ** application and select the **Smart Diagnosis** feature in the menu. Follow the instructions provided in the **LG ThinQ** application.

Using Audible Diagnosis to Diagnose Issues

Follow the instructions below to use the audible diagnosis method.

- Launch the **LG ThinQ** application and select the **Smart Diagnosis** feature in the menu. Follow the instructions for audible diagnosis provided in the **LG ThinQ** application.

- 1 Open the **LG ThinQ** application on the smart phone.
- 2 In the application, select the appliance from your list of connected appliances and then press the dots at the upper right of the screen.
- 3 Select **Smart Diagnosis**, then press the **Start Smart Diagnosis** button.

NOTE

- If the diagnosis fails several times, use the following instructions.

- 4 Select the **Audible Diagnosis**.
- 5 Follow the instructions on the smart phone.
- 6 Keep the phone in place until the tone transmission has finished. View the diagnosis on the phone.

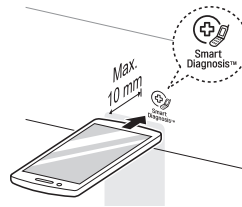

NOTE

- For best results, do not move the phone while the tones are being transmitted.

MAINTENANCE

Gas Surface Burners

CAUTION

- Do not clean this appliance with bleach.
- To prevent burns, wait until the cooktop has cooled down before touching any of its parts.
- Always wear gloves when cleaning the cooktop.

Removing and Replacing the Gas Surface Burners

Grates and burner heads/caps can be removed for care and cleaning.

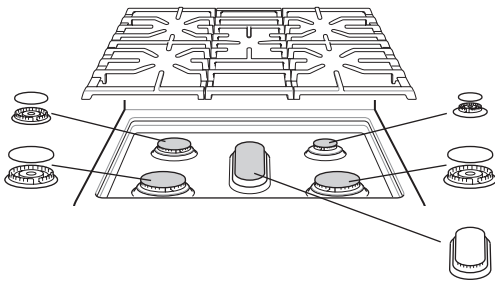

	General burner
Burner cap is properly set.	
Burner cap is NOT properly set.	

CAUTION

- To avoid burns, do not clean the cooktop surface until it has cooled.
- Do not lift the cooktop surface. Lifting the cooktop surface can lead to damage and improper operation of the range.

Foods with high acid or sugar content may cause a dull spot if allowed to set. Wash and rinse soon after the surface has cooled. For other spills such as oil/grease spattering, etc., wash with soap and water when the surface has cooled, then rinse and polish with a dry cloth.

Cleaning Burner Heads/Caps

For even and unhampered flame, the slits in the burner heads must be kept clean at all times. The burner heads and caps (and the oval burner head and cap assembly) can be lifted off. Do not attempt to remove the oval burner middle cap.

- Wash the burner caps in hot soapy water and rinse with clean water. Run water through the oval burner from the bottom stem to flush out debris.
- Use care when cleaning the cooktop. The pointed metal ends on the electrodes could cause injury. Hitting an electrode with a hard object may damage it.
- To remove burnt-on food, soak the burner heads in a solution of mild liquid detergent and hot water for 20–30 minutes. For stubborn stains, use a toothbrush or wire brush.
- The burners will not operate properly if the burner ports or electrodes are clogged or dirty.
- Burner caps and heads should be cleaned routinely, especially after excessive spillover.
- Burners will not light if the cap is removed.

CAUTION

- Do not hit the electrodes with anything hard. Doing so could damage them.
- Do not use steel wool or scouring powders to clean the burners.

After Cleaning the Burner Heads/Caps

Shake out any excess water and then let them dry thoroughly. Placing the oval burner upside down will allow the water to drain out more easily. Replace the burner heads and caps over the electrodes on the cooktop in the correct locations according to their size. Make sure the hole in the burner head is positioned over the electrode.

Burner Grates

The range consists of three separate professional-style grates. For maximum stability, these grates should only be used when in their proper position. The two side grates can be interchanged from left to right and front to back. The center grate can be interchanged from front to back.

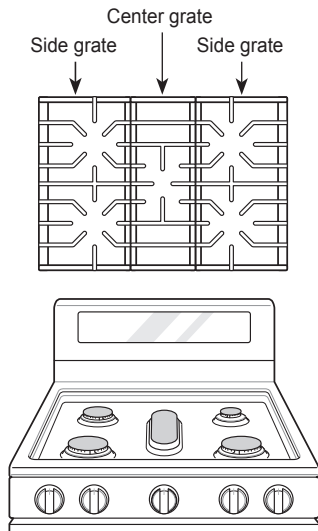

NOTE

Do not operate a burner for an extended period of time without cookware on the grate. The finish on the grate may chip without cookware to absorb the heat.

Cleaning the Burner Grates

CAUTION

- Do not lift the grates out until they have cooled.

- Grates should be washed regularly and after spillovers.
- Wash the grates in hot, soapy water and rinse with clean water.
- The grates are dishwasher safe.
- After cleaning the grates, let them dry completely and securely position them over the burners.

Cleaning the Cooktop Surface

CAUTION

- To avoid burns, do not clean the cooktop surface until it has cooled.
- Do not lift the cooktop surface. Lifting the cooktop surface can lead to damage and improper operation of the range.

- 1 Carefully remove all items from the top of the range, including grates and knobs.
- 2 Spray the cleared range top surface with a grease remover. (**DO NOT** use chlorine bleach, ammonia or other cleaners.)
- 3 Use a soft, dry cloth to remove all food and grease residue. **DO NOT** use abrasive cloths, sponges, or cleaners which may dull or scratch the surface.
- 4 Rinse off the cloth in hot water and continue to wipe the surface until all of the soap residue is removed.

Oven Air Vents

Air openings are located at the rear of the cooktop, at the top and bottom of the oven door, and at the bottom of the range.



CAUTION

- **The edges of the range vent are sharp.** Wear gloves when cleaning the range to avoid injury.
- Clean ventilating hoods frequently. Grease should not be allowed to accumulate on the hood or filter.

NOTE

Do not block the vents and air openings of the range. They provide the air inlet and outlet that are necessary for the range to operate properly with correct combustion.

Control Panel

To prevent activating the control panel during cleaning, unplug the range. Clean up splatters with a damp cloth using a glass cleaner. Remove heavier soil with warm, soapy water. Do not use abrasives of any kind.

CAUTION

Do not use the cooktop at high temperatures for an excessive period as the control panel could be damaged.

NOTE

When spraying on the glass surface, intermittent touch operation is possible.

Front Manifold Panel and Knobs

Clean the knobs and manifold panel after each use. For best results, use a damp cloth and mild soapy water or a 50/50 solution of vinegar and water. Rinse using clean water and immediately dry and polish with a soft cloth.

CAUTION

- To avoid damaging the finish on the knobs and manifold panel, do not use abrasive cleaners, strong liquid cleaners, plastic scouring pads or oven cleaners.
- Do not try to bend the knobs by pulling them up or down, and do not hang a towel or other object on them. Doing so can damage the gas valve shaft.
- The control knobs may be removed for easy cleaning.
- To remove the knobs, make sure that they are in the **Off** position and pull them straight off the stems.
- To replace the knobs, make sure the knob has the **Off** position centered at the top, and slide the knob directly onto the stem.

Cleaning the Exterior

Painted and Decorative Trim

For general cleaning, use a cloth with hot soapy water. For more difficult soils and built-up grease, apply a liquid detergent directly onto the soil. Leave it on for 30 to 60 minutes. Rinse with a damp cloth and dry. Do not use abrasive cleaners.

Stainless Steel Surfaces

To avoid scratches, do not use steel wool pads.

- 1 Place a small amount of stainless steel appliance cleaner or polish on a damp cloth or paper towel.
- 2 Clean a small area, rubbing with the grain of the stainless steel if applicable.
- 3 Dry and buff with a clean, dry paper towel or soft cloth.
- 4 Repeat as necessary.

NOTE

- Do not use a steel wool pad; it will scratch the surface.
- To clean the stainless steel surface, use warm sudsy water or a stainless steel cleaner or polish.
- Always wipe in the direction of the metal surface finish.
- To purchase stainless steel appliance cleaner or polish, or to locate a dealer near you, call our toll-free customer service number: 1-800-243-0000 (USA), 1-888-542-2623(CANADA) or visit our website at: www.lg.com

Oven Door

- Use soapy water to thoroughly clean the oven door. Rinse well. Do not immerse the door in water.
- You may use a glass cleaner on the outside glass of the oven door. Do not spray water or glass cleaner on the door vents.
- Do not use oven cleaners, cleaning powders, or harsh abrasive cleaning materials on the outside of the oven door.
- Do not clean the oven door gasket. The oven door gasket is made of a woven material that is essential for a good seal. Care should be taken not to rub, damage, or remove this gasket.

CAUTION

Do not use harsh cleaners or harsh abrasive cleaning materials on the outside of the oven door. Doing so can cause damage.

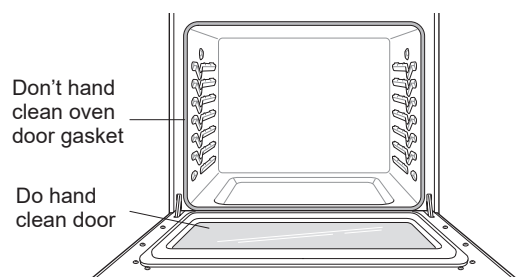

Door Care Instructions

Most oven doors contain glass that can break.

CAUTION

- Do not close the oven door until all the oven racks are fully in place.
- Do not hit the glass with pots, pans, or any other object.
- Scratching, hitting, jarring, or stressing the glass may weaken its structure causing an increased risk of breakage at a later time.

Oven Racks

Remove the oven racks before operating the self clean cycle.

- 1 Food spilled into the tracks could cause the racks to become stuck. Clean racks with a mild, abrasive cleaner.
- 2 Rinse with clean water and dry.

EasyClean®

LG's EasyClean® enamel technology provides two cleaning options for the inside of the range. The EasyClean® feature takes advantage of LG's new enamel to help lift soils without harsh chemicals, and it runs using ONLY WATER for just 10 minutes in low temperatures to help loosen LIGHT soils before hand-cleaning.

While EasyClean® is quick and effective for small and LIGHT soils, the Self Clean feature can be used to remove HEAVY, built up soils. The intensity and high heat of the Self Clean cycle may result in smoke which will require the opening up of windows to provide ventilation. Compared to the more intense Self Clean process, your LG oven gives you the option of cleaning with LESS HEAT, LESS TIME, and virtually NO SMOKE OR FUMES.

Benefits of EasyClean®

- Helps loosen light soils before hand-cleaning
- EasyClean® only uses water; no chemical cleaners
- Makes for a better self-clean experience
 - Minimizes smoke and odors
 - Delays the need for a self-clean cycle
 - Can allow shorter self-clean time

NOTE

Some models do not include a self-clean option. The EasyClean® feature may not be effective in removing heavy, built-up soils. If the range does not include a self-clean option, clean the oven regularly using the EasyClean® feature to prevent heavy, burnt-on soil from building up in the oven.

When to Use EasyClean®

EasyClean® Instruction Guide

- 1 Remove oven racks and accessories from the oven.
- 2 Scrape off and remove any burnt-on debris with a plastic scraper.

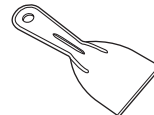

Suggested plastic scrapers:

- Hard plastic spatula
- Plastic pan scraper
- Plastic paint scraper
- Old credit card

Suggested Cleaning Method	Example of Oven Soiling	Soil Pattern	Types of Soils	Common Food Items That Can Soil Your Oven
EasyClean®		Small drops or spots	Cheese or other ingredients	Pizza
		Light splatter	Fat/grease	Steaks, broiled
				Fish, broiled
Self Clean* (For Some Models)		Medium to heavy splatter	Fat/grease	Meat roasted at high temperatures
		Drops or spots	Filling or sugar based soils	Pies
			Cream or tomato sauce	Casseroles

* The Self Clean cycle can be used for soil that has been built up over time.

- 3 Fill a spray bottle with water (10 oz or 300 ml) and use the spray bottle to thoroughly spray the inside surfaces of the oven.
- 4 Use at least $\frac{1}{5}$ (2 oz or 60 ml) of the water in the bottle to completely saturate the soil on both the walls and in the corners of the oven.

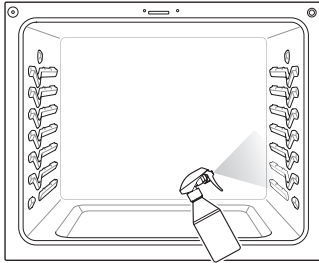

- 5 Spray or pour the remaining water (8 oz or 250 ml) onto the bottom center of the oven cavity. The indentation on the oven bottom should be fully covered to submerge all soils. Add water if necessary.

NOTE

If cleaning multiple ovens, use an entire bottle of water to clean each oven. Do not spray water directly on the door. Doing so will result in water (10 oz or 300 ml) dripping to the floor.

- 6 Close the oven door. Press **EasyClean®**. Press **Start**.

CAUTION

- Some surfaces may be hot after the EasyClean® cycle. Wear rubber gloves while cleaning to prevent burns.
- During the EasyClean® cycle, the oven becomes hot enough to cause burns. Wait until the cycle is over before wiping the inside surface of the oven. Failure to do so may result in burns.
- Avoid leaning or resting on the oven door glass while cleaning the oven cavity.

- 7 A tone will sound at the end of the 10 minutes cycle. Press **Clear/Off** to clear the display and end the tone.
- 8 After the cleaning cycle and during hand-cleaning, enough water should remain on the oven bottom to completely submerge all soils. Add water if necessary. Place a towel on the floor in front of the oven to capture any water that may spill out during hand-cleaning.
- 9 Clean the oven cavity immediately after the EasyClean® cycle by scrubbing with a wet, non-scratch scouring sponge or pad. (The scouring side will not scratch the finish.) Some water may spill into the bottom vents while cleaning, but it will be captured in a pan under the oven cavity and will not hurt the burner.

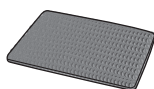
**NOTE**

Do not use any steel scouring pads, abrasive pads or cleaners as these materials can permanently damage the oven surface.

- 10 Once the oven cavity is cleaned, wipe any excess water with a clean dry towel. Replace racks and any other accessories.
- 11 If some light soils remain, repeat the above steps, making sure to thoroughly soak the soiled areas. If stubborn soils remain after multiple EasyClean® cycles.

NOTE

- If you forget to saturate the inside of the oven with water before starting EasyClean®, press **Clear/Off** to end the cycle. Wait for the range to cool to room temperature and then spray or pour water into the oven and start another EasyClean® cycle.
- The cavity gasket may be wet when the EasyClean® cycle finishes. This is normal. Do not clean the gasket.
- If mineral deposits remain on the oven bottom after cleaning, use a cloth or sponge soaked in vinegar to remove them.
- Using commercial oven cleaners or bleach to clean the oven is not recommended. Instead, use a mild liquid cleanser with a pH value below 12.7 to avoid discoloring the enamel.

Cleaning Tips

- Allow the oven to cool to room temperature before using the EasyClean® cycle. If your oven cavity is above 150 °F (65 °C), **Hot** will appear in the display, and the EasyClean® cycle will not be activated until the oven cavity cools down.
- Using the rough side of a non-scratch scouring pad may help to take off burnt-on stains better than a soft sponge or towel.
- Certain non-scratch scrubbing sponges, such as those made of melamine foam, available at your local store, can also help improve cleaning.
- The range should be level to ensure that the bottom surface of the oven cavity is entirely covered by water at the beginning of the EasyClean® cycle.
- For best results, use distilled or filtered water. Tap water may leave mineral deposits on the oven bottom.
- Soil baked on through several cooking cycles will be more difficult to remove with the EasyClean® cycle.
- Do not open the oven door during the EasyClean® cycle. Water will not get hot enough if the door is opened during the cycle.

Self Clean (Only model LRGL5825*/LRGL5823*)

This feature is not available in model LRGL5821*.

The Self Clean cycle uses extremely hot temperatures to clean the oven cavity. While running the Self Clean cycle, you may notice smoking or an odor. This is normal, especially if the oven is heavily soiled.

During Self Clean, the kitchen should be well ventilated to minimize the odors from cleaning.

Before Starting Self Clean

- Remove the oven racks, broiler pan, broiler grid, all cookware, aluminum foil or any other material from the oven.
- The kitchen should be well ventilated to minimize the odors from cleaning.
- Wipe any heavy spillovers on the bottom of the oven.
- Make sure that the oven light bulb cover is in place and the oven light is off.
- The oven light cannot be turned on during a Self Clean cycle. The oven light cannot be turned on until the oven temperature has cooled below 500 °F (260 °C) after a Self Clean cycle is complete.

CAUTION

- Do not leave small children unattended near the appliance. During the Self Clean cycle, the outside of the range can become very hot to the touch.
- If you have pet birds, move them to another well-ventilated room. Some birds are extremely sensitive to the fumes given off during the Self Clean cycle of any range.
- Do not line the oven walls, racks, bottom or any other part of the range with aluminum foil or any other material. Doing so will destroy heat distribution, produce poor baking results and cause permanent damage to the oven interior (aluminum foil will melt to the interior surface of the oven).
- Do not force the door open. This can damage the automatic door locking system. Use care when opening the oven door after the Self Clean cycle. Stand to the side of the oven when opening the door to allow hot air or steam to escape. The oven may still be VERY HOT.

During the Self Clean cycle, the cooktop elements cannot be used.

NOTE

- Remove oven racks and accessories before starting the Self Clean cycle.
- If oven racks are left in the oven cavity during the Self Clean cycle, they will discolor and become difficult to slide in and out.
- Clean the frame of the oven and door with hot soapy water. Rinse well.
- Do not clean the gasket. The fiberglass material of the oven door gasket cannot withstand abrasion. It is essential for the gasket to remain intact. If you notice it becoming worn or frayed, replace it.
- Wipe up any heavy spillovers on the oven bottom.
- Make sure that the oven light bulb cover is in place and the oven light is off.
- If the cooktop is used during Self Clean operation, a buzzer will sound for 1 minute and then Self Clean will turn off.
- If the cooktop is in use when a Self Clean is activated, a buzzer will sound and Self Clean will not start.

Setting Self Clean

The Self Clean function has cycle times of 3, 4, or 5 hours.

Self Clean Soil Guide

Soil Level	Cycle Setting
Lightly Soiled Oven Cavity	3-Hour Self Clean
Moderately Soiled Oven Cavity	4-Hour Self Clean
Heavily Soiled Oven Cavity	5-Hour Self Clean

- 1 Remove all racks and accessories from the oven.
- 2 Press the **Self Clean** button. The oven defaults to the recommended four-hour self clean for a moderately soiled oven. Press **Self Clean** to select a self clean time of 3, 4, or 5 hours.
- 3 Press **Start**.
- 4 Once the self-clean cycle is set, the oven door locks automatically and the lock icon displays. You will not be able to open the oven door until the oven has cooled. The lock releases automatically when the oven has cooled.

CAUTION

Do not force the oven door open when the lock icon is displayed. The oven door remains locked until the oven temperature has cooled. Forcing the door open will damage the door.

Setting Self Clean with a Delayed Start

- 1 Remove all racks and accessories from the oven.
- 2 Press the **Self Clean** button. The oven defaults to the recommended four-hour self clean for a moderately soiled oven.
Press **Self Clean** button to set the time.
- 3 Press **Start Time**.
- 4 **Model LRGL5825***
Use the **number** buttons to enter the time of day you would like the Self Clean to start.

Model LRGL5823*

Press the **+/-** buttons until the display shows the time of day you would like the Self Clean to start.

- 5 Press **Start**.

NOTE

It may become necessary to cancel or interrupt a Self Clean cycle due to excessive smoke or fire in the oven. To cancel the Self Clean function, press the **CLEAR/OFF** button.

During Self Clean

- The Self Clean cycle uses extremely hot temperatures to clean the oven cavity. While running the Self Clean cycle, you may notice smoking or an odor. This is normal, especially if the oven is heavily soiled.
- As the oven heats, you may hear sounds of metal parts expanding and contracting. This is normal and will not damage the oven.
- Do not force the oven door open when the lock  is displayed. The oven door remains locked until the oven temperature has cooled. Forcing the door open will damage the door.

After the Self Clean Cycle

- The oven door remains locked until the oven temperature has cooled.
- You may notice some white ash in the oven. Wipe it off with a damp cloth or a soap-filled steel wool pad after the oven cools. If the oven is not clean after one self-clean cycle, repeat the cycle.
- If oven racks were left in the oven and do not slide smoothly after a self-clean cycle, wipe racks and rack supports with a small amount of vegetable oil to make them glide more easily.
- Fine lines may appear in the porcelain because it went through heating and cooling. This is normal and will not affect performance.

NOTE

- The Self Clean cycle cannot be started if the Lockout feature is active.
- Once the Self Clean cycle is set, the oven door locks automatically. You will not be able to open the oven door until the oven is cooled. The lock releases automatically.
- Once the door has been locked, the lock  indicator light stops flashing and remains on. Allow about 15 seconds for the oven door lock to activate.
- If the clock is set for a 12-hour display (default) the Delayed Self Clean can never be set to start more than 12 hours in advance.
- After the oven is turned off, the convection fan keeps operating until the oven has cooled down.

Changing the Oven Light

The oven light is a standard 40-watt appliance bulb. It turns on when the oven door is open. When the oven door is closed, press Light or knock twice on the oven door glass to turn it on or off.

! WARNING

- Make sure that the oven and bulb are cool.
- Disconnect the electrical power to the range at the main fuse or circuit breaker panel. Failure to do so can result in severe personal injury, death, or electric shock.

- 1 Unplug the range or disconnect power.
- 2 Turn the glass bulb cover in the back of the oven counterclockwise to remove.
- 3 Pull the bulb out of the socket.
- 4 Insert a new bulb into the socket.
- 5 Insert the glass bulb cover and turn it clockwise.
- 6 Plug in the range or reconnect the power.

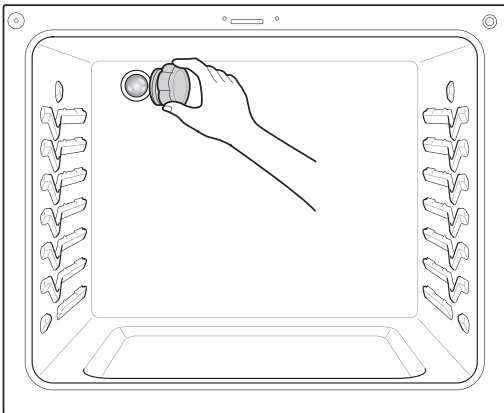

Removing and Replacing the Lift-Off Oven Doors and Drawer

! CAUTION

- Be careful when removing and lifting the door.
- Do not lift the door by the handle. The door is very heavy.

Removing the Door

- 1 Fully open the door.
- 2 Unlock the hinge locks, rotating them as far toward the open door frame as they will go.

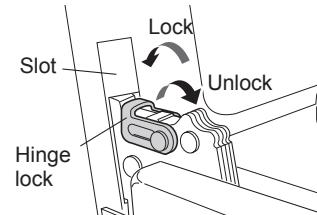

- 3 Firmly grasp both sides of the door at the top.
- 4 Close the door to the removal position (approximately five degrees) which is halfway between the broil stop position and fully closed. If the position is correct, the hinge arms will move freely.

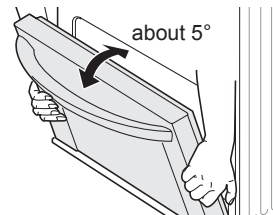

- 5 Lift door up and out until the hinge arms are clear of the slots.

Replacing the Door

- 1 Firmly grasp both sides of the door at the top.
- 2 With the door at the same angle as the removal position, seat the indentation of the hinge arms into the bottom edge of the hinge slots. The notch in the hinge arms must be fully seated into the bottom edge of the slots.

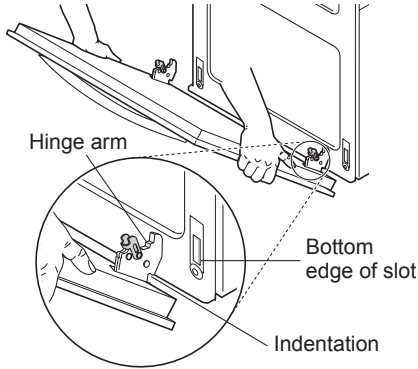

- 3 Open the door fully. If the door will not open fully, the indentation is not seated correctly in the bottom edge of the slots.
- 4 Lock the hinge locks, rotating them back toward the slots in the oven frame until they lock.

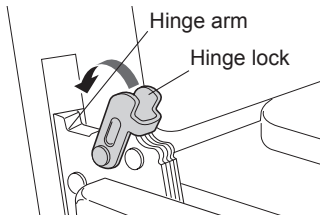

- 5 Close the oven door.

Removing the Drawer

CAUTION

Disconnect the electrical power to the range at the main fuse or circuit breaker panel. Failure to do so can result in severe personal injury, death, or electric shock.

Most cleaning can be done with the drawer in place; however, the drawer may be removed if further cleaning is needed. Use warm water to thoroughly clean.

- 1 Pull the drawer out until it stops.

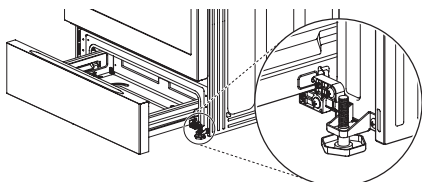

- 2 Unscrew the 2 screws on the back of the drawer.

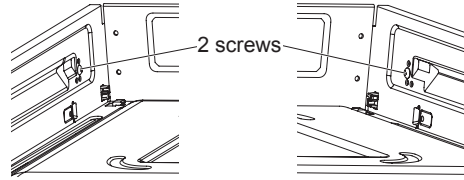

- 3 Lift the front of the drawer until the stops clear the guides.

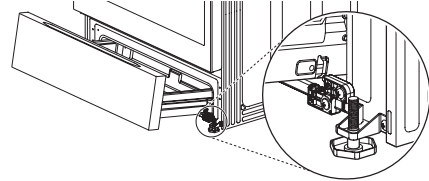

- 4 Remove the drawer.

Replacing the Drawer

- 1 Place the drawer rails on the guides.

- 2 Push the drawer back until it stops.

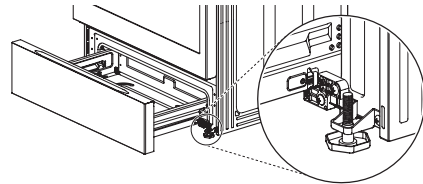

- 3 Lift the front of the drawer and push back until the stops clear the guides.

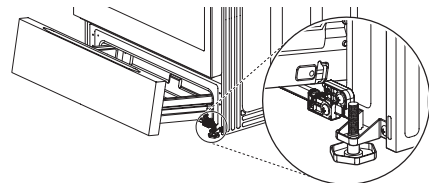

- 4 Screw the 2 screws on the back of the drawer.

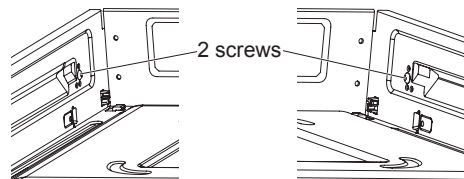

- 5 Lower the front of the drawer and push back until it closes.

TROUBLESHOOTING

FAQs

What types of cookware are recommended for use with the cooktop?

- The pans must have a flat bottom and straight sides.
- Only use heavy-gauge pans.
- The pan size must match the amount of food to be prepared and the size of the surface element.
- Use tight fitting lids.
- Only use flat-bottom woks.

My new oven doesn't cook like my old one. Is there something wrong with the temperature settings?

No, your oven has been factory tested and calibrated. For the first few uses, follow your recipe times and temperatures carefully. If you still think your new oven is too hot or too cold, you can adjust the oven temperature yourself to meet your specific cooking needs. Refer to the Oven Temperature Adjustment section in this manual for easy instructions on how to adjust your thermostat.

Is it normal to hear a clicking noise coming from the back of my oven when I am using it?

Your new range is designed to maintain a tighter control over your oven's temperature. You may hear your oven's heating elements click on and off more frequently on your new oven. This is NORMAL.

Why is the time flashing?

This means that the product has just been plugged in, or that it has experienced a power interruption. To clear the flashing time, press any button and reset the clock if needed.

Can I use aluminum foil to catch drippings in my oven cavity?

Never use aluminum foil to line the bottom or sides of the oven or the warming drawer. The foil will melt and stick to the bottom surface of the oven and will not be removable. Use a sheet pan placed on a lower oven rack to catch drippings instead. (If foil has already melted onto the bottom of the oven, it will not interfere with the oven's performance.)

Can I use aluminum foil on the racks?

Do not cover racks with aluminum foil. Covering entire racks with foil restricts air flow, leading to poor cooking results. Use a sheet pan lined with foil under fruit pies or other acidic or sugary foods to prevent spillovers from damaging the oven finish.



CAUTION

Foil may be used to wrap food in the oven or warming drawer, but do not allow the foil to come into contact with the exposed heating/broiling elements in the oven. The foil could melt or ignite, causing smoke, fire, or injury.

What should I do if my racks are sticky and have become hard to slide in and out?

Over time, the racks may become hard to slide in and out. Apply a small amount of olive oil to the ends of the racks. This will work as a lubricant for easier gliding.

What should I do for hard to remove stains on my cooktop?

The cooktop should be cleaned after every use to prevent permanent staining. When cooking foods with high sugar content, such as tomato sauce, clean the stain off with a scraper while the cooktop is still warm. Use an oven mitt when scraping to prevent burns. Refer to the MAINTENANCE section of this owner's manual for further instruction.

Why aren't the function buttons working?

Make sure that the range is not in Lockout mode.

LOCKED will show in the display if Lockout is activated. To deactivate Lockout, press and hold **Clear/Off** for three seconds.

My range is still dirty after running the EasyClean® cycle. What else should I do?

The EasyClean® cycle only helps to loosen light soils in your oven range to assist in hand-cleaning of your oven. It does not automatically remove all soils after the cycle. Some scrubbing of your oven range is required after running the EasyClean® cycle.

I tried scrubbing my oven after running EasyClean®, but some soils still remain. What can I do?

The EasyClean® feature works best when the soils are fully soaked and submerged in water before running the cycle and during hand-cleaning. If soils are not sufficiently soaked in water, it can negatively affect the cleaning performance. Repeat the EasyClean® process using sufficient water. Sugar-based and certain greasy soils are especially hard to clean.

Soils on my oven walls are not coming off. How can I get my walls clean?

Soils on the side and rear walls of your oven range may be more difficult to fully soak with water. Try repeating the EasyClean® process with more than the $\frac{1}{5}$ of spray bottle recommended.

Will EasyClean® get all of the soils and stains out completely?

It depends on the soil type. Sugar-based and certain grease stains are especially hard to clean. Also, if stains are not sufficiently soaked in water, this can negatively affect cleaning performance.

Do I need to use the full contents of the spray bottle for EasyClean®?

Yes. It is highly recommended that $\frac{4}{5}$ of the water be sprayed or poured on the bottom and an additional $\frac{1}{5}$ of the water be sprayed on walls and other soiled areas to fully saturate the soils for better cleaning performance.

I see smoke coming out of my oven range's cooktop vents during EasyClean®. Is this normal?

This is normal. This is not smoke. It is actually water vapor (steam) from the water in the oven cavity. As the oven heats briefly during EasyClean®, the water in the cavity evaporates and escapes through the oven vents.

How often should I use EasyClean®?

EasyClean® can be performed as often as you wish. EasyClean® works best when your oven is LIGHTLY soiled from such things as LIGHT grease splatter and small drops of cheese. Please refer to the EasyClean® section in your owner's manual for more information.

What is required for EasyClean®?

A spray bottle filled with water, a scraper, a non-scratch scrubbing pad and a towel. You should not use abrasive scrubbers such as heavy-duty scouring pads or steel wool.

Is it safe for water to spill into the oven bottom vents during cleaning?

Some water spillage into the oven bottom vents (gas range) is okay. However, it is recommended to try avoid spilling too much water into the vents.

Before Calling for Service

Before you call for service, review this list. It may save you time and expense. The list includes common occurrences that are not the result of defective workmanship or materials in this appliance.

Symptoms	Possible Cause / Solutions
Top burners do not light or do not burn evenly.	<ul style="list-style-type: none"> • Make sure that the electrical plug is inserted into a live, properly grounded outlet. • Remove the burners and clean them. Check the electrode area for burnt on food or grease. See Cleaning Burner Heads/Caps in the MAINTENANCE section. • Make sure that the burner parts are installed correctly. See Removing and Replacing the Gas Surface Burners in the MAINTENANCE section.
Buttons not working	<ul style="list-style-type: none"> • If the Lockout feature is on, most controls will be disabled. To turn off the Lockout feature, press and hold the Clear/Off button for 3 seconds. • The sensitivity of buttons is highest at the center. Press buttons in the center, even when activating a button's secondary function. The buttons will not work properly if they are pressed too far from the center.
Burner flames are very large or yellow.	If the range is connected to LP gas, contact the technician who installed your range or made the conversion.
Surface burners light but the oven does not.	Make sure that the oven gas shut-off valve, located behind the range, is fully open.
Food does not bake or roast properly.	<ul style="list-style-type: none"> • Incorrect oven control settings. See Control Panel Overview in the OPERATION section. • Incorrect rack position. See Removing and Replacing the Oven Racks in the OPERATION section. • Incorrect cookware is being used. See Convection Bake in the OPERATION section. • Oven thermostat needs adjustment. • See Adjusting the Oven Thermostat in the OPERATION section. • The Clock is not set correctly. See Changing Oven Settings in the OPERATION section. • Aluminum foil used improperly in the oven. See Removing and Replacing the Oven Racks.
Food does not broil properly in the oven.	<ul style="list-style-type: none"> • Incorrect oven control settings. See Control Panel Overview in the OPERATION section. • The oven door is not closed. See Broil in the OPERATION section. • Aluminum foil used on the broiling pan and grid is not fitted properly.
Oven temperature is too hot or too cold.	The oven thermostat needs adjustment. See Adjusting the Oven Thermostat in the OPERATION section.
Clock and timer does not work.	<ul style="list-style-type: none"> • Make sure the electrical plug is inserted into a live, properly grounded outlet. Replace the fuse or reset the circuit breaker. • Improper oven control settings. See Changing Oven Settings in the OPERATION section.
Oven light does not work.	<ul style="list-style-type: none"> • The light bulb is loose or defective. Tighten or replace the bulb. • The plug on the range is not completely inserted in the electrical outlet. Make sure the electrical plug is inserted into a live, properly grounded outlet.
Self Clean is not working.	<ul style="list-style-type: none"> • The oven temperature is too high to set a self clean operation. Allow the range to cool down to room temperature and reset the controls. • Improper oven control settings. See Self Clean in the MAINTENANCE section.

Symptoms	Possible Cause / Solutions						
“Crackling” or “popping” sound.	<ul style="list-style-type: none"> This is the sound of the metal heating up and cooling down during both the cooking and cleaning functions. This is normal. 						
Too much smoke during the Self Clean cycle.	Too much soil in the oven. Open the windows to get rid of the smoke from the room. Press the CLEAR/OFF button to cancel Self Clean. Wait until the light goes off before trying to open the oven door. Wipe up the excess soil and reset the clean cycle.						
The oven door does not open after a Self Clean cycle.	The oven temperature is too high. Wait up to one hour for it to cool down.						
The oven door is not clean after a Self Clean cycle.	<ul style="list-style-type: none"> Incorrect oven control settings. See Self Clean in the MAINTENANCE section. The oven was heavily soiled. Clean up heavy spills before beginning the Self Clean cycle. Heavily soiled ovens may need either a longer Self Clean or two Self Clean cycles. 						
Clean and door flash in the display	<ul style="list-style-type: none"> The self clean cycle has been selected, but the door is not closed. <ul style="list-style-type: none"> Close the oven door. 						
Oven control beeps and displays an F error code.	<ul style="list-style-type: none"> Check the main gas shut-off valve or the oven gas shut-off valve and call for service. Remove the power from the range for five minutes and then reconnect the power. If the function error code repeats, call for service. <table border="1" data-bbox="855 721 1296 858"> <thead> <tr> <th>CODE</th> <th>CAUSE</th> </tr> </thead> <tbody> <tr> <td>F-3</td> <td>Key short error</td> </tr> <tr> <td>F-9</td> <td>Oven not heating</td> </tr> </tbody> </table>	CODE	CAUSE	F-3	Key short error	F-9	Oven not heating
CODE	CAUSE						
F-3	Key short error						
F-9	Oven not heating						
The oven racks were cleaned in a Self Clean cycle.	Apply a small amount of vegetable oil to a paper towel and wipe the edges of the oven racks. Do not use lubricant sprays.						
Clock is flashing.	Power outage or surge. Reset the clock. If the oven was in use, you must reset it by pressing the CLEAR/OFF button. Reset the clock and any cooking function.						
“Burning” or “oily” odor emitting from the vent.	This is normal in a new oven and will disappear with use. To speed the process, set a Self Clean cycle for a minimum of three hours. See Self Clean in the MAINTENANCE section.						
Strong odor.	An odor from the insulation around the inside of the oven is normal for the first few times the oven is used.						
Fan noise	<ul style="list-style-type: none"> A convection fan may automatically turn on and off. <ul style="list-style-type: none"> This is normal. 						
Fan operation	It is normal for the fan to operate periodically throughout a normal bake cycle in the oven. This is to ensure even baking results.						
Burners are not lighting properly after cleaning the cooktop surface.	Make sure that the burner heads and caps are completely dry and properly positioned.						
When lighting just one burner, clicking noise is heard from all the burners.	This is normal. Electric spark igniters from the burners cause the clicking noise. All the spark igniters on the cooktop will activate when igniting just one burner.						
Light can be seen through the oven air vents.	While the Broil function is running, it is normal to see a light between the oven air vents.						

LIMITED WARRANTY (USA)

ARBITRATION NOTICE: THIS LIMITED WARRANTY CONTAINS AN ARBITRATION PROVISION THAT REQUIRES YOU AND LG TO RESOLVE DISPUTES BY BINDING ARBITRATION INSTEAD OF IN COURT, UNLESS YOU CHOOSE TO OPT OUT. IN ARBITRATION, CLASS ACTIONS AND JURY TRIALS ARE NOT PERMITTED. PLEASE SEE THE SECTION TITLED "PROCEDURE FOR RESOLVING DISPUTES" BELOW.

Should your LG Gas Range ("Product") fail due to a defect in materials or workmanship under normal and proper use, during the warranty period set forth below, LG Electronics ("LG") will, at its option, repair or replace the Product. This limited warranty is valid only to the original retail purchaser of the Product and applies only when purchased and used within the United States including U.S. Territories.

Warranty Period	Scope of Warranty	HOW SERVICE IS HANDLED
One (1) year from date of original retail purchase	Parts and Labor (internal / functional parts only)	LG will provide, free of charge, all labor and in-home service to replace defective part(s).

- Replacement products and parts are warranted for the remaining portion of the original warranty period or ninety (90) days, whichever is greater.
- Replacement products and parts may be new, reconditioned, refurbished, or otherwise factory remanufactured.
- Proof of original retail purchase specifying the Product model and date of purchase is required to obtain warranty service under this limited warranty.



EXCEPT TO THE EXTENT PROHIBITED BY APPLICABLE LAW, ANY IMPLIED WARRANTY OF MERCHANTABILITY OR FITNESS FOR A PARTICULAR PURPOSE ON THE PRODUCT IS LIMITED IN DURATION TO THE DURATION OF THE ABOVE LIMITED WARRANTY. UNDER NO CIRCUMSTANCES SHALL LG OR ITS U.S. DISTRIBUTORS/ DEALERS BE LIABLE FOR ANY INDIRECT, INCIDENTAL, CONSEQUENTIAL, SPECIAL, OR PUNITIVE DAMAGES, INCLUDING, WITHOUT LIMITATION, LOST GOODWILL, LOST REVENUES OR PROFITS, WORK STOPPAGE, IMPAIRMENT OF OTHER GOODS, COST OF REMOVAL AND REINSTALLATION OF THE PRODUCT, LOSS OF USE, OR ANY OTHER DAMAGES WHETHER BASED IN CONTRACT, TORT, OR OTHERWISE. LG'S TOTAL LIABILITY, IF ANY, SHALL NOT EXCEED THE PURCHASE PRICE PAID BY YOU FOR THE PRODUCT.

Some states do not allow the exclusion or limitation of incidental or consequential damages or limitations on how long an implied warranty lasts, so the above exclusions or limitations may not apply to you. This limited warranty gives you specific legal rights and you may also have other rights that vary from state to state.

THIS LIMITED WARRANTY DOES NOT COVER:

- Service trips to deliver, pick up, or install, educate how to operate, correct wiring, or correct unauthorized repairs.
- Damage or failure of the Product to perform during power failures and interrupted or inadequate electrical service.
- Damage or failure resulting from operating the Product in a corrosive atmosphere or contrary to the Product owner's manual.
- Damage or failure to the Product caused by accidents, pests and vermin, lightning, wind, fire, floods, acts of God, or any other causes beyond the control of LG.
- Damage or failure caused by unauthorized modification or alteration, or if used for other than the intended purpose.
- Damage or failure resulting from misuse, abuse, improper installation, repair, or maintenance. Improper repair includes use of parts not authorized by LG. Improper installation or maintenance includes installation or maintenance contrary to the Product owner's manual.
- Damage or failure caused by incorrect electrical current, voltage, or ventilation/plumbing codes.
- Damage or failure caused by transportation and handling, including scratches, dents, chips, and/or other damage to the finish of the Product, unless such damage is reported within one (1) week of delivery.
- Damage or missing items to any display, open box, or discounted Product.
- Refurbished Product or any Product sold "As Is", "Where Is", "With all Faults", or similar disclaimer.
- Products with original serial numbers that have been removed, altered, or cannot be readily determined.
- Increases in utility costs and additional utility expenses.
- Any noises associated with normal operation.
- Use of accessories, components, or consumable cleaning products that are not authorized by LG.
- Replacement of light bulbs, filters, fuses or any other consumable parts.
- When Product is used for other than normal and proper household use (e.g. commercial or industrial use, offices, and recreational facilities or vehicles) or contrary to the instructions outlined in the Product's owner's manual.
- Costs associated with removal and reinstallation of your Product for repairs.
- Cost of conversion of the Product from natural gas to LP gas or vice versa.
- Shelves, drawers and accessories, except for internal/functional parts covered under this limited warranty.

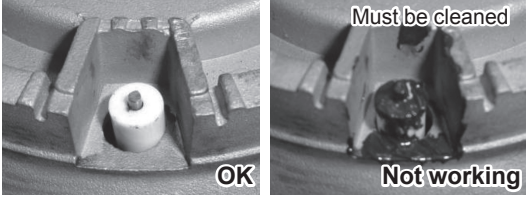
Not Covered by this Limited Warranty

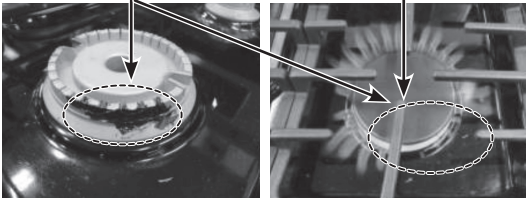
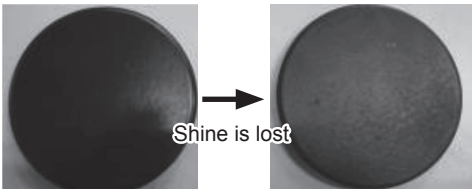
Problem	Cause	Prevention
<ul style="list-style-type: none"> Cooktop enamel chipping off 	<p>Improper usage</p> 	<ul style="list-style-type: none"> Do not hit enamel cooktop
<ul style="list-style-type: none"> Burners do not light 	<p>Clogged or dirty burner ports or electrodes will not allow the burner to operate properly</p> 	<ul style="list-style-type: none"> Check and clean the gas electrode.
<ul style="list-style-type: none"> Uneven flame 	<ol style="list-style-type: none"> Improper burner cap installation <ul style="list-style-type: none"> Burner cap is properly seated. Burner cap is NOT properly seated.  Burner ports clogged by food residue <ul style="list-style-type: none"> Ports blocked by dirt Flames uneven  	<ul style="list-style-type: none"> Check installation of burner head and cap Hardened residue should be removed using a toothbrush.
<ul style="list-style-type: none"> Burner cap color changes and becomes dull 	<ol style="list-style-type: none"> Scratching Use of detergent or abrasive cleansers 	<ul style="list-style-type: none"> Do not use steel wool or abrasive cleansers to clean. To remove burnt-on food, soak the burner heads in hot water for 20–30 minutes. (Do not use detergent)

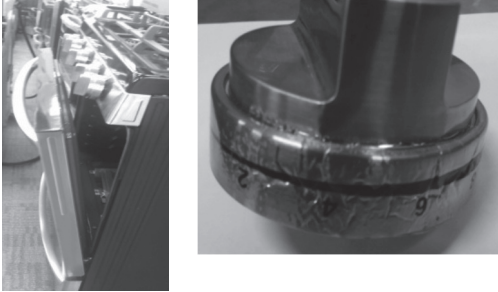
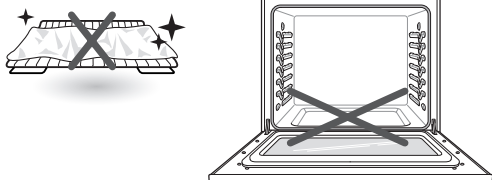
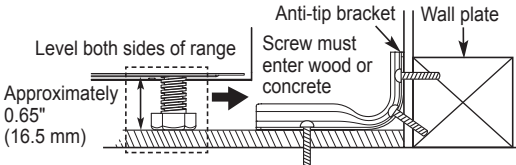
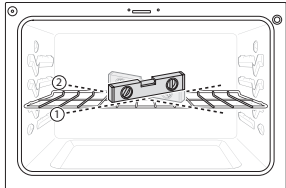
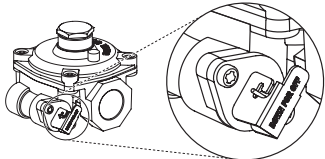
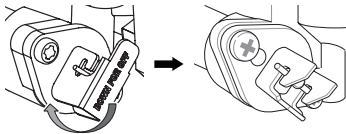
Problem	Cause	Prevention
<ul style="list-style-type: none"> Knobs melt 	<p>Improper usage</p> 	<ul style="list-style-type: none"> Do not leave door at stop position during Broil/Bake mode or right after cooking.
<ul style="list-style-type: none"> Oven or racks are stained after using aluminum foil 	<p>Aluminum foil has melted in the oven</p> 	<ul style="list-style-type: none"> Never cover the oven bottom or cover an entire rack with materials such as aluminum foil. If the foil has already melted onto the oven, it will not affect the performance of the oven.
<ul style="list-style-type: none"> Flame or power is weak 	<p>Gas pressure may be weak</p>	<ul style="list-style-type: none"> Check with gas supplier first
<ul style="list-style-type: none"> Surface is not level Oven is tipping 	<ol style="list-style-type: none"> Range not leveled Anti-tip device not installed correctly   <p>Use carpenter's level to check level.</p>	<ul style="list-style-type: none"> Check with installer first
<ul style="list-style-type: none"> Oven shows error code (F9, F19) but cooktop burners are working. 	<p>The gas pressure regulator valve is closed.</p>  <p>Lever's closed position</p>	<ul style="list-style-type: none"> Check that the regulator valve is in the open position. If the regulator valve is closed, rotate the lever to open the valve.  <p>Lever's closed position Lever's open position</p>

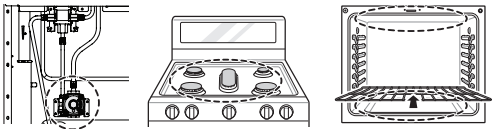
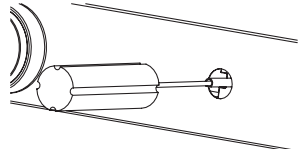
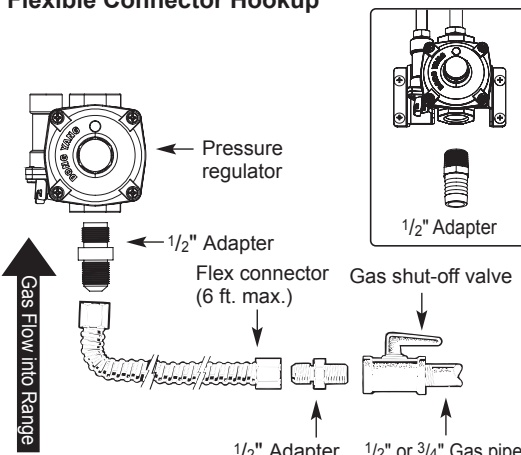
Problem	Cause	Prevention
<ul style="list-style-type: none"> Flames too big on converted cooktop (NP → LP) 	<p>The installer missed part of the conversion. (Check 3 parts: regulator, cooktop nozzles, broil/bake nozzles.)</p>  <p>regulator cooktop nozzles broil/bake nozzles</p>	<ul style="list-style-type: none"> Check with installer first Refer to installation manual
<ul style="list-style-type: none"> Flame is too small or too large 	<ol style="list-style-type: none"> Variable gas pressure Installer did not check  <p>Center adjustment screw</p>	<ul style="list-style-type: none"> Check with installer first
<ul style="list-style-type: none"> Gas smell 	<p>Improper connection</p> <p>Flexible Connector Hookup</p>  <p>Pressure regulator</p> <p>1/2" Adapter</p> <p>Flex connector (6 ft. max.)</p> <p>Gas shut-off valve</p> <p>1/2" Adapter</p> <p>1/2" or 3/4" Gas pipe</p> <p>Gas Flow into Range</p>	<ul style="list-style-type: none"> Check with installer first

The cost of repair or replacement under the above excluded circumstances shall be borne by the consumer.

TO OBTAIN WARRANTY SERVICE AND ADDITIONAL INFORMATION

Call 1-800-243-0000 and select the appropriate option from the menu.

Or visit our website at <http://www.lg.com>

Or by mail: LG Electronics Customer Service P.O. Box 240007 Huntsville, AL 35813 ATTN: CIC

PROCEDURE FOR RESOLVING DISPUTES:

ALL DISPUTES BETWEEN YOU AND LG ARISING OUT OF OR RELATING IN ANY WAY TO THIS LIMITED WARRANTY OR THE PRODUCT SHALL BE RESOLVED EXCLUSIVELY THROUGH BINDING ARBITRATION, AND NOT IN A COURT OF GENERAL JURISDICTION. BINDING ARBITRATION MEANS THAT YOU AND LG ARE EACH WAIVING THE RIGHT TO A JURY TRIAL AND TO BRING OR PARTICIPATE IN A CLASS ACTION.

Definitions. For the purposes of this section, references to “LG” mean LG Electronics U.S.A., Inc., its parents, subsidiaries and affiliates, and each of their officers, directors, employees, agents, beneficiaries, predecessors in interest, successors, assigns and suppliers; references to “dispute” or “claim” shall include any dispute, claim or controversy of any kind whatsoever (whether based in contract, tort, statute, regulation, ordinance, fraud, misrepresentation or any other legal or equitable theory) arising out of or relating in any way to the sale, condition or performance of the product or this Limited Warranty.

Notice of Dispute. In the event you intend to commence an arbitration proceeding, you must first notify LG in writing at least 30 days in advance of initiating the arbitration by sending a letter to LG at LG Electronics, USA, Inc. Attn: Legal Department- Arbitration 111 Sylvan Avenue, Englewood Cliffs, NJ 07632. You and LG agree to engage in good faith discussions in an attempt to amicably resolve your claim. The notice must provide your name, address, and telephone number; identify the product that is the subject of the claim; and describe the nature of the claim and the relief being sought. If you and LG are unable to resolve the dispute within 30 days, either party may proceed to file a claim for arbitration.

Agreement to Binding Arbitration and Class Action Waiver. Upon failure to resolve the dispute during the 30 day period after sending written notice to LG, you and LG agree to resolve any claims between us only by binding arbitration on an individual basis, unless you opt out as provided below. Any dispute between you and LG shall not be combined or consolidated with a dispute involving any other person’s or entity’s product or claim. More specifically, without limitation of the foregoing, any dispute between you and LG shall not under any circumstances proceed as part of a class or representative action. Instead of arbitration, either party may bring an individual action in small claims court, but that small claims court action may not be brought on a class or representative basis.

Arbitration Rules and Procedures. To begin arbitration of a claim, either you or LG must make a written demand for arbitration. The arbitration will be administered by the American Arbitration Association (“AAA”) and will be conducted before a single arbitrator under the AAA’s Consumer Arbitration Rules that are in effect at the time the arbitration is initiated (referred to as the “AAA Rules”) and under the procedures set forth in this section. The AAA Rules are available online at www.adr.org/consumer. Send a copy of your written demand for arbitration, as well as a copy of this provision, to the AAA in the manner described in the AAA Rules. You must also send a copy of your written demand to LG at LG Electronics, USA, Inc. Attn: Legal Department- Arbitration 111 Sylvan Avenue, Englewood Cliffs, NJ 07632. If there is a conflict between the AAA Rules and the rules set forth in this section, the rules set forth in this section will govern. This arbitration provision is governed by the Federal Arbitration Act. Judgment may be entered on the arbitrator’s award in any court of competent jurisdiction. All issues are for the arbitrator to decide, except that issues relating to the scope and enforceability of the arbitration provision and to the arbitrability of the dispute are for the court to decide. The arbitrator is bound by the terms of this provision.

Governing Law. The law of the state of your residence shall govern this Limited Warranty and any disputes between us except to the extent that such law is preempted by or inconsistent with applicable federal law.

Fees/Costs. You do not need to pay any fee to begin an arbitration. Upon receipt of your written demand for arbitration, LG will promptly pay all arbitration filing fees to the AAA unless you seek more than \$25,000 in damages, in which case the payment of these fees will be governed by the AAA Rules. Except as otherwise provided for herein, LG will pay all AAA filing, administration and arbitrator fees for any arbitration initiated in accordance with the AAA Rules and this arbitration provision. If you prevail in the arbitration, LG will pay your attorneys’ fees and expenses as long as they are reasonable, by considering factors including, but not limited to, the purchase amount and claim amount. Notwithstanding the foregoing, if applicable law allows for an award of reasonable attorneys’ fees and expenses, an arbitrator can award them to the same extent that a court would. If the arbitrator finds either the substance of your claim or the relief sought in the demand is frivolous or brought for an improper purpose (as measured by the standards set forth in Federal Rule of Civil Procedure 11(b)), then the payment of all arbitration fees will be governed by the AAA Rules. In such a situation, you agree to reimburse LG for all monies previously disbursed by it that are otherwise your obligation to pay under the AAA Rules. Except as otherwise provided for, LG waives any rights it may have to seek attorneys’ fees and expenses from you if LG prevails in the arbitration.

Hearings and Location. If your claim is for \$25,000 or less, you may choose to have the arbitration conducted solely on the basis of (1) documents submitted to the arbitrator, (2) through a telephonic hearing, or (3) by an in-person hearing as established by the AAA Rules. If your claim exceeds \$25,000, the right to a hearing will be determined by the AAA Rules. Any in-person arbitration hearings will be held at a location within the federal judicial district in which you reside unless we both agree to another location or we agree to a telephonic arbitration.

Opt Out. You may opt out of this dispute resolution procedure. If you opt out, neither you nor LG can require the other to participate in an arbitration proceeding. To opt out, you must send notice to LG no later than 30 calendar days from the date of the first consumer purchaser's purchase of the product by either: (i) sending an e-mail to optout@lge.com, with the subject line: "Arbitration Opt Out" or (ii) calling 1-800-980-2973. You must include in the opt out e-mail or provide by telephone: (a) your name and address; (b) the date on which the product was purchased; (c) the product model name or model number; and (d) the serial number (the serial number can be found (i) on the product; or (ii) online by accessing <https://www.lg.com/us/support/repair-service/schedule-repair-continued> and clicking on "Find My Model & Serial Number").

You may only opt out of the dispute resolution procedure in the manner described above (that is, by e-mail or telephone); no other form of notice will be effective to opt out of this dispute resolution procedure. Opting out of this dispute resolution procedure will not affect the coverage of the Limited Warranty in any way, and you will continue to enjoy the full benefits of the Limited Warranty. If you keep this product and do not opt out, then you accept all terms and conditions of the arbitration provision described above.