



LCD TV

OWNER'S MANUAL

MODELS: 15LC1R *

20LC1R *



Internet Home Page : <http://www.lge.com>
<http://www.lg.ca>

ENERGYSTAR is a set of power-saving guidelines issued by the U.S. Environmental Protection Agency(EPA).







As an ENERGY STAR Partner LGE U. S. A.,Inc. has determined that this product meets the ENERGY STAR guidelines for energy efficiency.

Please read this manual carefully before operating your set.
Retain it for future reference.
Record model number and serial number of the set.
See the label attached on the back cover and quote this information to your dealer when you require service.

P/NO : 38289U0559C (0601-REV00)
Printed in Korea

Warning

	<div style="border: 1px solid black; padding: 5px;">CAUTION RISK OF ELECTRIC SHOCK DO NOT OPEN</div>	
<p>WARNING: TO REDUCE THE RISK OF ELECTRIC SHOCK DO NOT REMOVE COVER (OR BACK). NO USER SERVICEABLE PARTS INSIDE. REFER TO QUALIFIED SERVICE PERSONNEL.</p>		
	<p>The lightning flash with arrowhead symbol, within an equilateral triangle, is intended to alert the user to the presence of uninsulated "dangerous voltage" within the product's enclosure that may be of sufficient magnitude to constitute a risk of electric shock to persons.</p>	
	<p>The exclamation point within an equilateral triangle is intended to alert the user to the presence of important operating and maintenance (servicing) instructions in the literature accompanying the appliance.</p>	

NOTE TO CABLE/TV INSTALLER:

This reminder is provided to call the CATV system installer's attention to Article 820-40 of the National Electric Code (U.S.A.). The code provides guidelines for proper grounding and, in particular, specifies that the cable ground shall be connected to the grounding system of the building, as close to the point of the cable entry as practical.

REGULATORY INFORMATION

This equipment has been tested and found to comply with the limits for a Class B digital device, pursuant to Part 15 of the FCC Rules. These limits are designed to provide reasonable protection against harmful interference in a residential installation. This equipment generates, uses and can radiate radio frequency energy and, if not installed and used in accordance with the instructions, may cause harmful interference to radio communications. However, there is no guarantee that interference will not occur in a particular installation. If this equipment does cause harmful interference to radio or television reception, which can be determined by turning the equipment off and on, the user is encouraged to try to correct the interference by one or more of the following measures:

- Reorient or relocate the receiving antenna.
- Increase the separation between the equipment and receiver.
- Connect the equipment into an outlet on a circuit different from that to which the receiver is connected.
- Consult the dealer or an experienced radio/TV technician for help.

Any changes or modifications not expressly approved by the party responsible for compliance could void the user's authority to operate the equipment.

CAUTION:

Do not attempt to modify this product in any way without written authorization from LG Electronics Corporation. Unauthorized modification could void the user's authority to operate this product.

U.S.A. only -----

COMPLIANCE:

The responsible party for this product's compliance is:
LG Electronics U.S.A., Inc.
1000 Sylvan Avenue, Englewood Cliffs, NJ 07632
Phone: 1-201-816-2000
<http://us.lge.com>

Safety Instructions

WARNING :

To Reduce The Risk Of Fire Or Electric Shock, Do Not Expose This Apparatus To Rain Or Moisture.

Apparatus shall not be exposed to dripping or splashing and no objects filled with liquids, such as vases, shall be placed on the apparatus.

IMPORTANT SAFETY INSTRUCTIONS

1. Read these instructions.

2. Keep these instructions.



3. Heed all warnings.

4. Follow all instructions.

5. Do not use this apparatus near water.

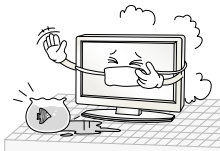

6. Clean only with a dry cloth.

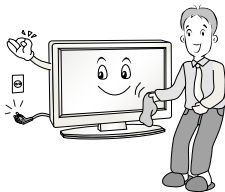

7. Do not block any of the ventilation openings. Install in accordance with the manufacturer's instructions.



8. Do not install near any heat sources such as radiators, heat registers, stoves, or other apparatus (including amplifiers) that produce heat.



9. Do not defeat the safety purpose of the polarized or grounding type plug. A polarized plug has two blades with one wider than the other. A grounding type plug has two blades and a third grounding prong. The wide blade or the third prong is provided for your safety. When the provided plug does not fit into your outlet, consult an electrician for replacement of the obsolete outlet.

10. Protect the power cord from being walked on or pinched particularly at plugs, convenience receptacles, and the point where they exit from the apparatus.



11. Only use the attachments / accessories specified by the manufacturer.

Safety Instructions continued

12. Use only with a cart, stand, tripod, bracket, or table specified by the manufacturer, or sold with the apparatus. When a cart is used, use caution when moving the cart / apparatus combination to avoid injury from tip-over.



13. Unplug this apparatus during lightning storms or when unused for long periods of time.



14. Refer all servicing to qualified service personnel. Servicing is required when the apparatus has been damaged in any way, such as power supply cord or plug is damaged, liquid has been spilled or objects have fallen into the apparatus, the apparatus has been exposed to rain or moisture, does not operate normally, or has been dropped.

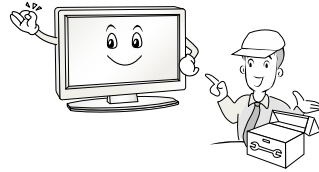

Note

- If the TV feels cold to the touch, there may be a small “flicker” when when it is turned on. This is normal, there is nothing wrong with TV.
- Some minute dot defects may be visible on the screen, appearing as tiny red, green, or blue spots. However, they have no adverse effect on the monitor's performance.
- Avoid touching the LCD screen or holding your finger(s) against it for long periods of time. Doing so may produce some temporary distortion effects on the screen.

CAUTION concerning the Power Cord

Most appliances recommend they be placed upon a dedicated circuit; that is, a single outlet circuit which powers only that appliance and has no additional outlets or branch circuits. Check the specification page of this owner's manual to be certain.

Do not overload wall outlets. Overloaded wall outlets, loose or damaged wall outlets, extension cords, frayed power cords, or damaged or cracked wire insulation are dangerous. Any of these conditions could result in electric shock or fire. Periodically examine the cord of your appliance, and if its appearance indicates damage or deterioration, unplug it, discontinue use of the appliance, and have the cord replaced with an exact replacement part by an authorized servicer.

Protect the power cord from physical or mechanical abuse, such as being twisted, kinked, pinched, closed in a door, or walked upon. Pay particular attention to plugs, wall outlets, and the point where the cord exits the appliance.

On Disposal

- a. The fluorescent lamp used in this product contains a small amount of mercury.
- b. Do not dispose of this product with general household waste.
Disposal of this product must be carried out in accordance to the regulations of your local authority.

Contents

Warnings	2	Sound Menu Options	
Safety Instructions	3~4	EZ Audio	21
Introduction		Equalizer Adjustments	21
Controls	6	AVL (Auto Volume Leveler)	21
Connection Options	7	Sound Balance	22
Remote Control Key Functions	8	Stereo/SAP Broadcasts Setup	22
Installation		Time Menu Options	
Accessories	9	Auto Clock Setup	23
Kensington Security System(Options) ..	9	Manual Clock Setup	23
Installation Instruction	10	On/Off Timer Setup	24
Please set it up carefully so the product doesn't		Sleep Timer Setup	24
fall over	12	Auto Off	24
External Equipment Connections ..	13~16	Special Menu Options	
Antenna Connection	13	Closed Captions	25
VCR Setup	14	Select Mode	26
Cable TV Setup	14	Key Lock	26
External A/V Source Setup	15	Power indicator	27
DVD Setup	15	Caption/Text	27
DTV Setup	16	Captions	27
PC Setup	16	Lock Menu Options	
Operation		Lock Menu Setup	29
TV Operation Overview	17	Screen Menu Options (15LC1R* only) ..	30
Menu Language Selection	17	Maintenance	31
Channel Menu Options		Product Specifications	31
Memorizing the Channels with EZ Scan ..	18	Troubleshooting Checklist	32
Add/Delete Channels with Manual			
Program	18		
Adjust frquency with Manual Program	18		
Favorite Channels Setup	19		
Picture Menu Options			
EZ Video	20		
ACC (Auto Color Control)	20		
Manual Picture Control	20		

After reading this manual, keep it handy for future reference.

Introduction

Controls

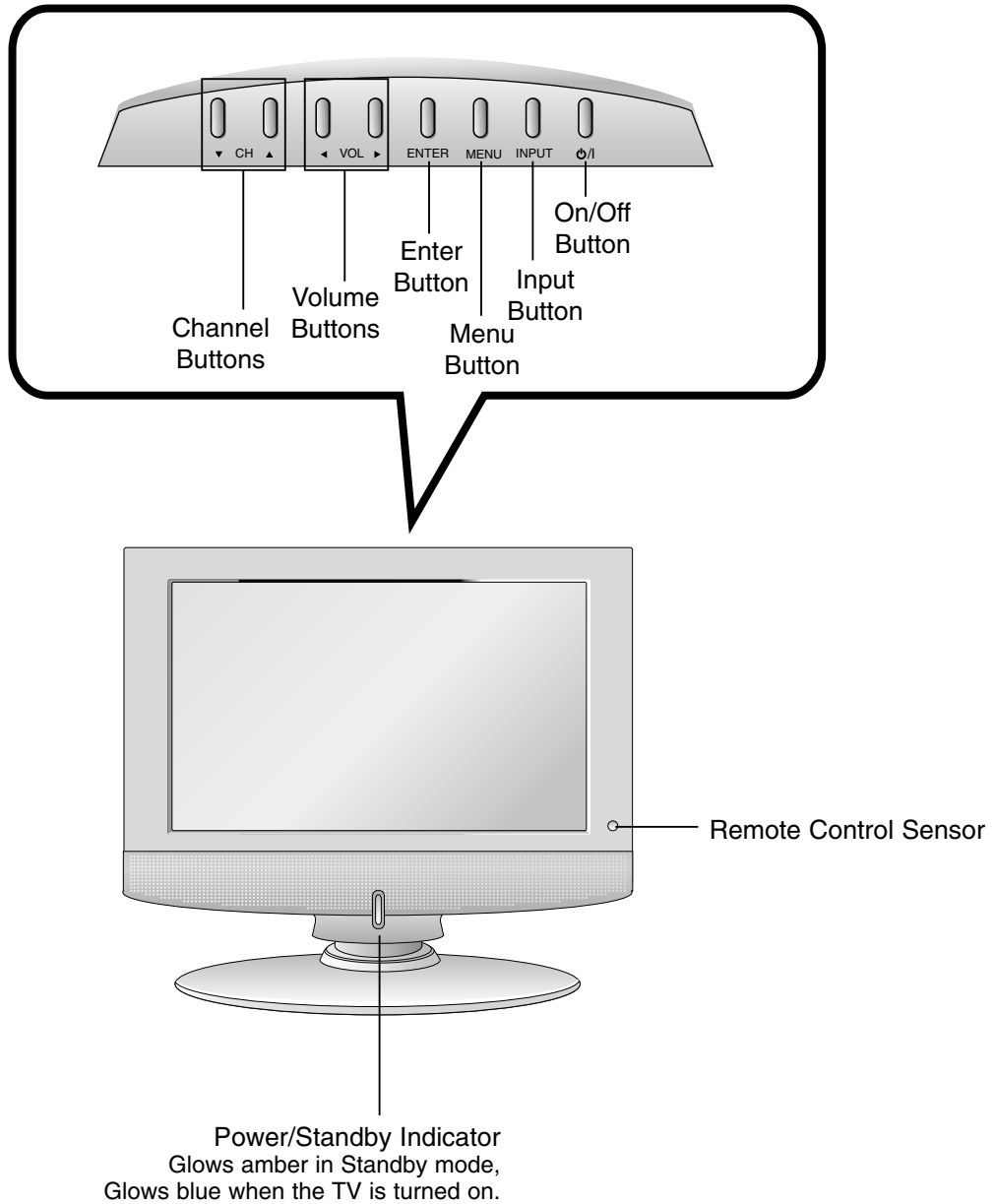

Connection Options

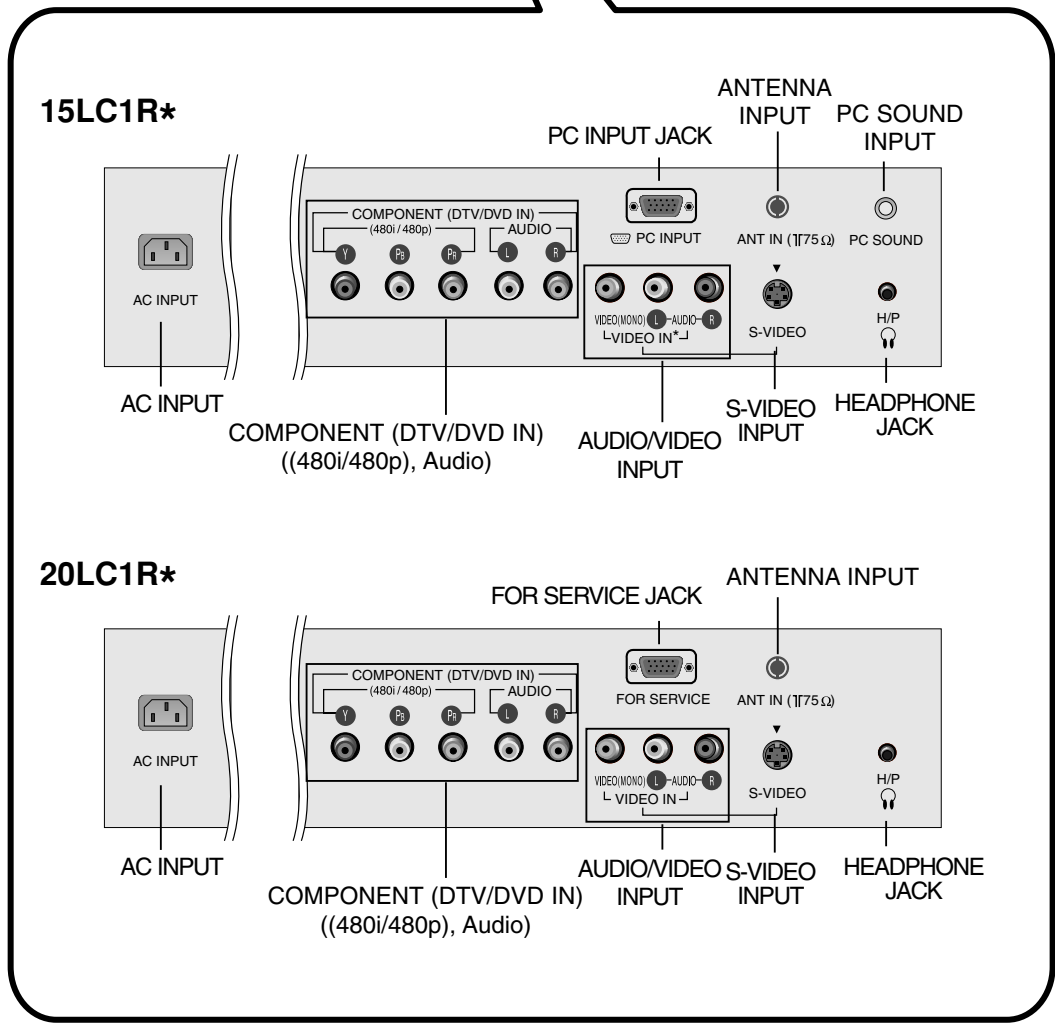
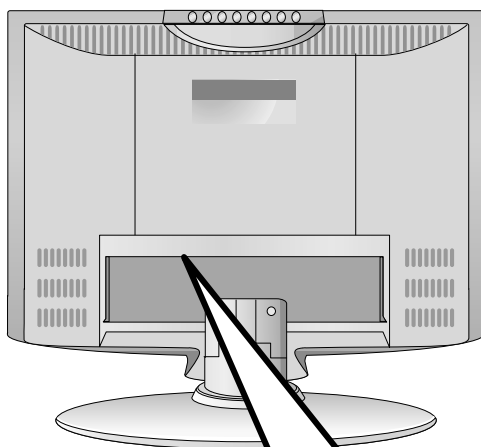

Remote Control Key Functions

- When using the remote control, aim it at the remote control sensor on the TV.

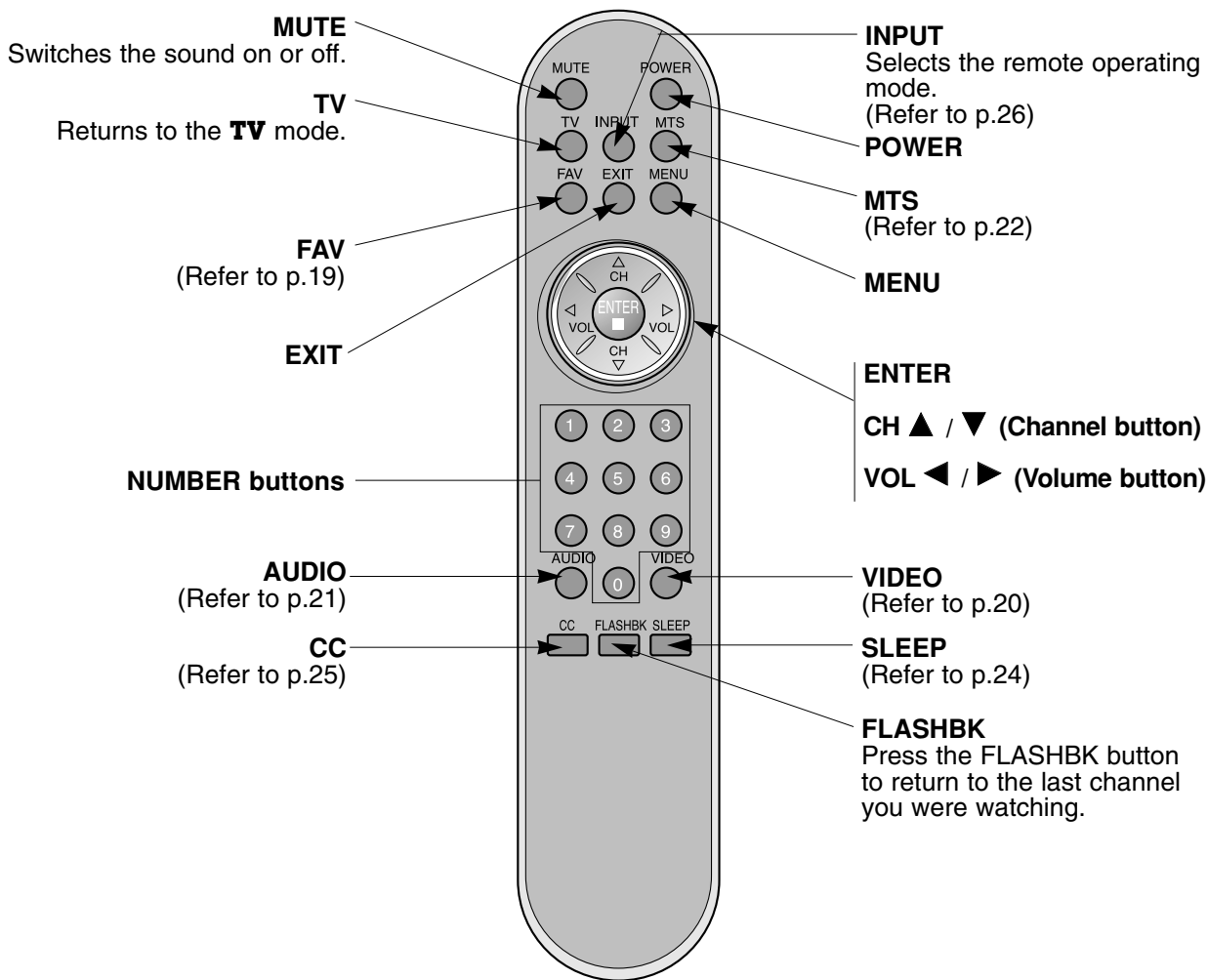

Installing Batteries

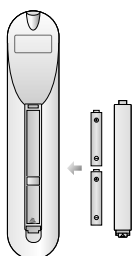

- Open the battery compartment cover on the back side and insert the batteries with correct polarity.
- Use two 1.5V batteries of AAA type. Don't mix used batteries with new batteries.

Installation

Accessories

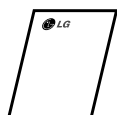

Owner's Manual

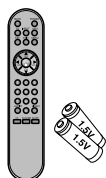
AAA Batteries
Remote Control

Power Cord

Tie Holder
- Arrange the wires
with the tie Holder.D-sub cable (PC)
(15LC1R*)Audio cable (PC)
(15LC1R*)2-TV
Bracket Bolts1-TV Bracket,
2-Wall Bracket
(20LC1R*)2-TV Bracket,
2-Wall Bracket
(15LC1R*)

Installation guide



Rack



4-Anchor

4-Screws for wall
mount rack2-Ring spacers
(20LC1R* only)

Fixing screw

Kensington Security System

- The TV is equipped with a Kensington Security System connector on the back panel. Connect the Kensington Security System cable as shown below.
- For the detailed installation and use of the Kensington Security System, refer to the user's guide provided with the Kensington Security System.
For further information, contact <http://www.kensington.com>, the internet homepage of the Kensington company. Kensington sells security systems for expensive electronic equipment such as notebook PCs and LCD projectors.

NOTE

- The Kensington Security System is an optional accessory.

NOTES

- If the TV feels cold to the touch, there may be a small "flicker" when when it is turned on.
This is normal, there is nothing wrong with TV.
- Some minute dot defects may be visible on the screen, appearing as tiny red, green, or blue spots. However, they have no adverse effect on the monitor's performance.
- Avoid touching the LCD screen or holding your finger(s) against it for long periods of time.
Doing so may produce some temporary distortion effects on the screen.

15LC1R*

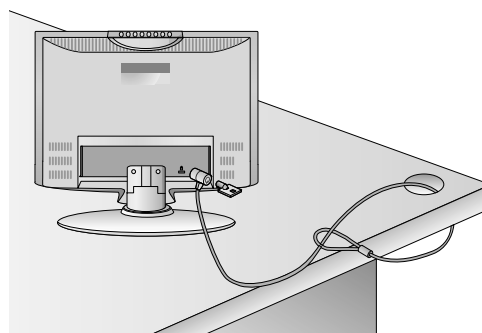

20LC1R*

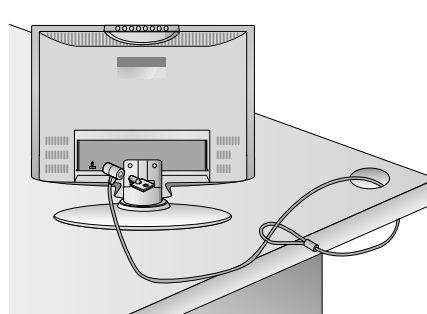

Installation Instruction

Unfolding the stand base

1. Place the set with its front facing downward on a cushion or soft cloth.
2. Hold down the release button inside the stand and strongly pull out the stand with your two hands.

Note: Here shown may be somewhat different from your set.

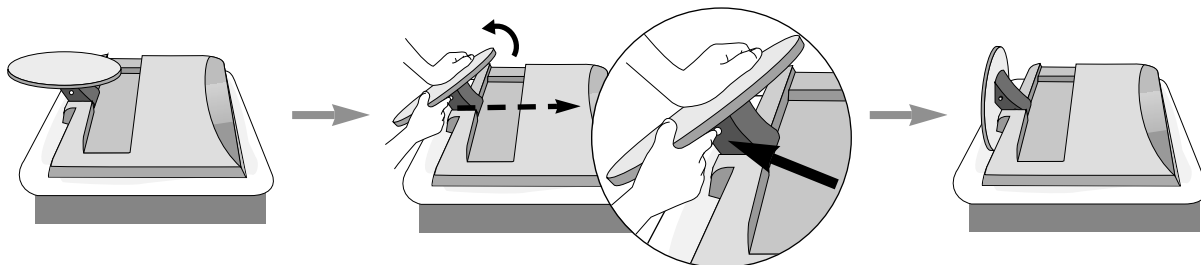

The stand won't move if you don't press release button.

Wall Mount: Horizontal installation

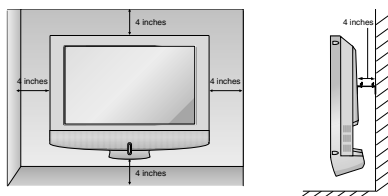
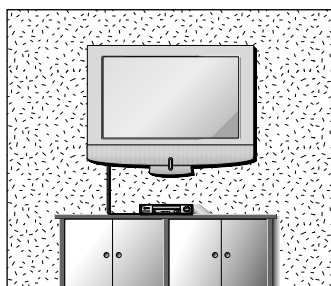

< 20LC1R* only >

2-Ring spacers

Place the ring spacers on the set before installing the wall mounting bracket so that the inclination of the backside of the set can be adjusted perpendicularly.

For proper ventilation, allow a clearance of 4" on each side and from the wall. Detailed installation instructions are available from your dealer, see the optional Tilt Wall Mounting Bracket Installation and Setup Guide.

Desktop Pedestal Installation

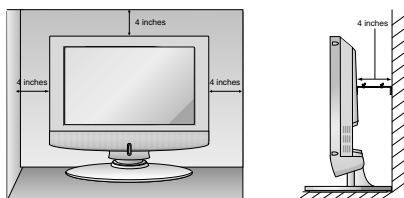
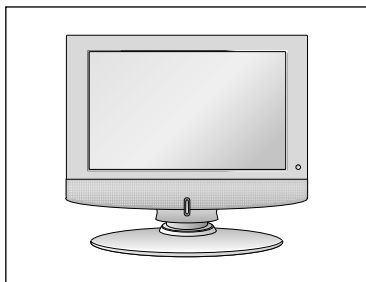

For proper ventilation, allow a clearance of 4" on each side and from the wall.

Installation Instruction Continued

Connection of TV

1. Connect the aerial cable to the socket marked $75\ \Omega$ on the back. For the best reception an outdoor aerial should be used.
2. To connect an additional equipment, see the **External Equipment Connections** section.
3. Connect the power cord.

Note: Here shown may be somewhat different from your set.

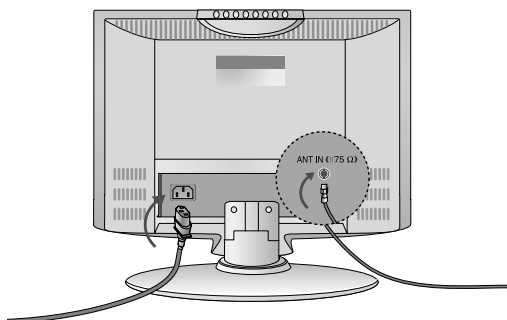

Positioning your display

Adjust the position of the panel in various ways for maximum comfort.

• Tilt range

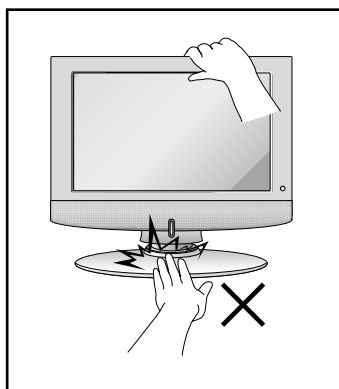
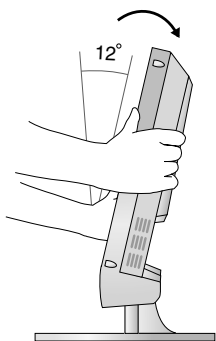

Be careful that your hands are not pressed down when tilting the screen.

Please set it up carefully so the product doesn't fall over

Set it up close to the wall so the product doesn't fall over when it is pushed backwards.

The instructions shown below is a safer way to set up the product, which is to fix it on the wall so the product doesn't fall over when it is pulled in the forward direction. It will prevent the product from falling forward and hurting people. It will also prevent the product from damage caused by fall. Please make sure that children don't climb on or hang from the product.

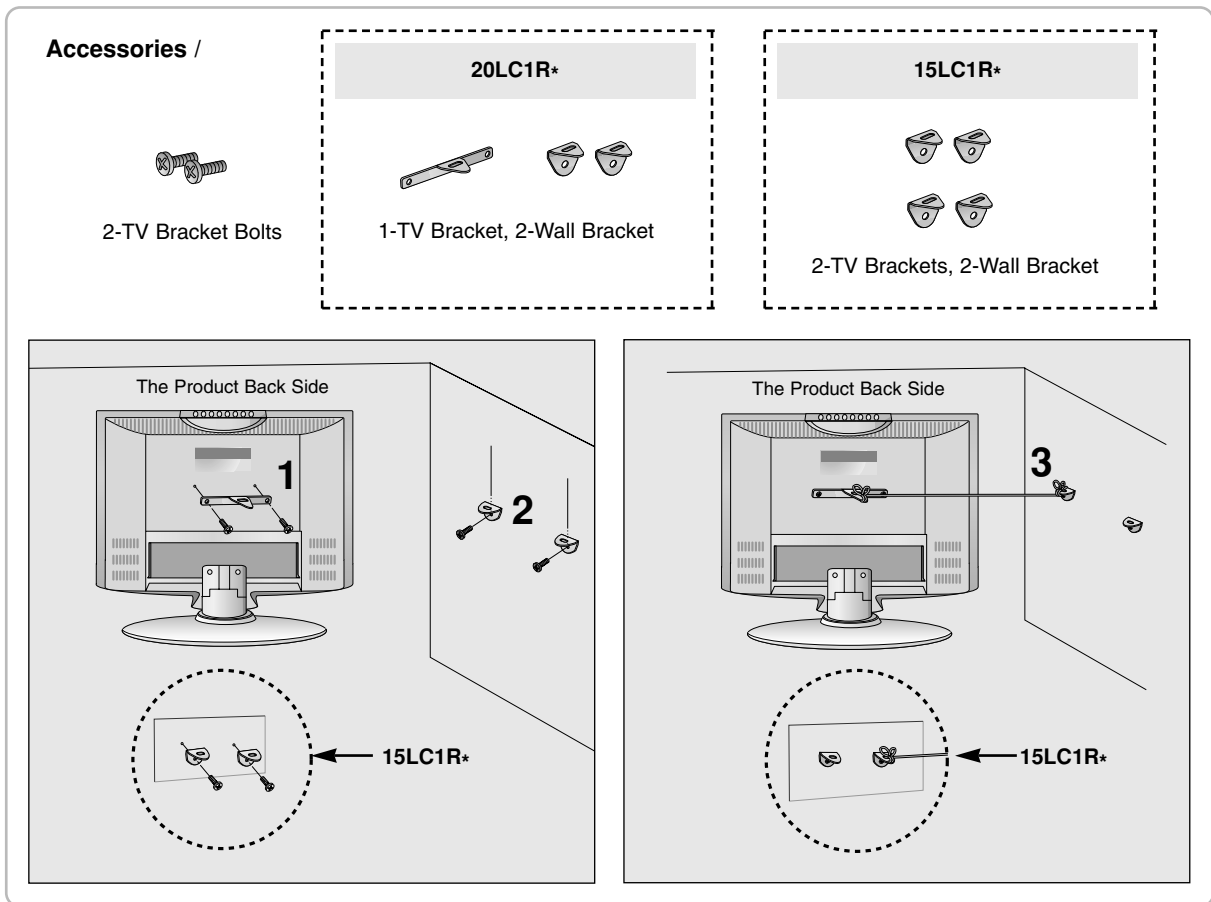

1. Use the bracket and the bolt to fix the product to the wall as shown in the picture.
2. Secure the bracket with the bolt (not provided as parts of the product, must purchase separately) on the wall.
3. Use a sturdy rope (not provided as parts of the product, must purchase separately) to tie the product. It is safer to tie the rope so it becomes horizontal between the wall and the product.

Notes

- When moving the product to another place undo the ropes first.
- Use a product holder or a cabinet that is big and strong enough for the size and weight of the product.
- To use the product safely make sure that the height of the bracket that is mounted on the wall is same as that of the product.

External Equipment Connections

Antenna Connection

- For optimum picture quality, adjust antenna direction.

Connecting to an Inside Antenna Setup

- Typical wall antenna jack used in apartment buildings, connect the antenna cable as shown below. (Use the correct type of antenna cable for the type of wall antenna jack.)

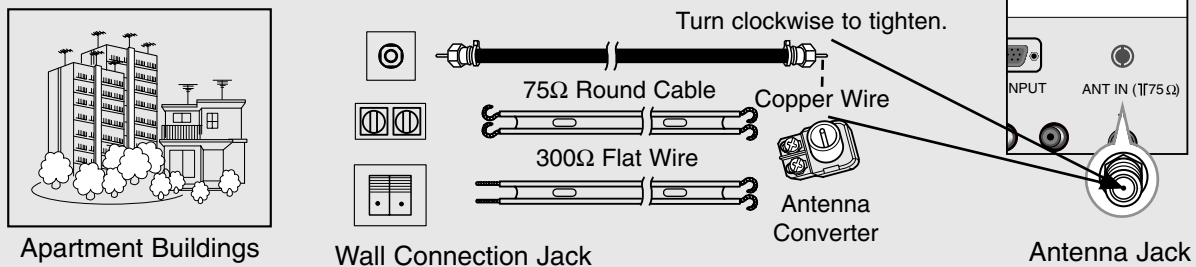

- If you have a 75Ω round cable, insert the bronze wire and then tighten the connection nut. If you have a 300Ω flat wire, connect the twisted wire to the antenna converter and then connect the converter to the antenna jack on the TV.
- If using 75Ω round cable, do not bend the bronze wire. It may cause poor picture quality.

Connecting to an Outdoor Antenna Setup

- This type of antenna is commonly used in single family dwellings.

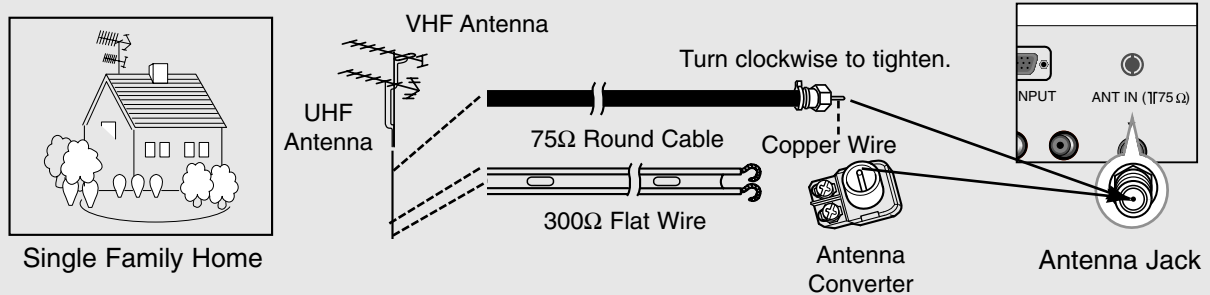

- In poor signal areas, to get better picture quality, install a signal amplifier to the antenna as shown to the right.
- If signal needs to be split for two TVs, use an antenna signal splitter for connection.

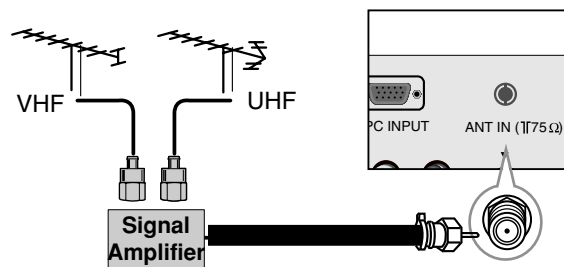

External Equipment Connections Continued

VCR Setup

- In Video mode, TV automatically reverts to TV mode if the **TV** buttons are pressed.

Connection 1

Set VCR switch to 3 or 4 and then tune TV to the same channel number.

Connection 2

1. Connect the audio/video output jacks on VCR to the corresponding input jacks on the TV. When connecting the TV to a VCR, match the jack colors (Video = yellow, Audio Left = white, and Audio Right = red).
2. Insert a video tape into the VCR and press **PLAY** on the VCR. (Refer to the VCR owner's manual.)
3. Use the **INPUT** button on the remote control to select **Video**. (If connected to S-VIDEO on rear panel, select the **Video** external input source.)

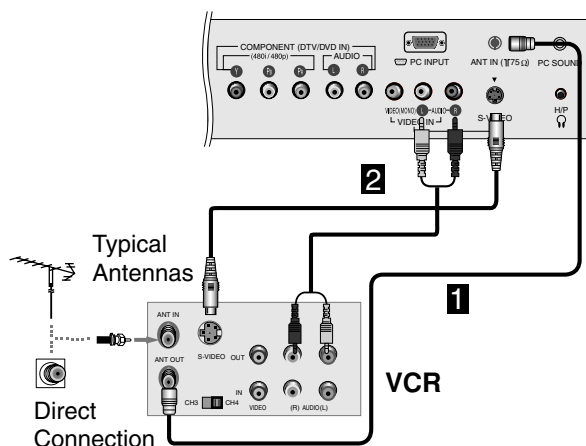
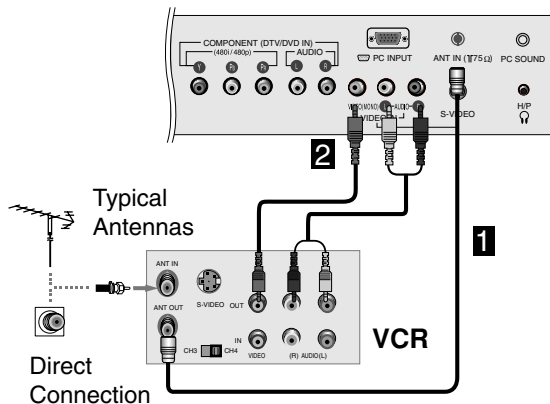

Cable TV Setup

- After subscribing to a local cable TV service and installing a converter, you can watch cable TV programming.
- For further cable TV information, contact a local cable service provider.

Connection 1

1. Select 3 or 4 with channel switch on cable box.
2. Tune the TV channel to the same selected output channel of cable box.
3. Select channels at the cable box or with the cable box remote control.

Connection 2

1. Connect the audio/video output jacks on Cable Box to the corresponding input jacks on the TV. When connecting the TV to Cable Box, match the jack colors (Video = yellow, Audio Left = white, and Audio Right = red).
2. Use the **INPUT** button on the remote control to select **Video**.
3. Select channels with the cable box remote control.

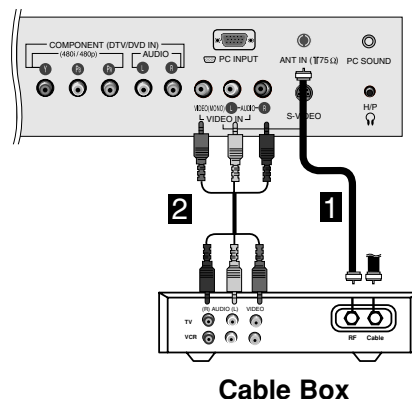

External A/V Source Setup

Connections

Connect the audio/video output jacks on the external A/V equipment to the corresponding input jacks on the TV. When connecting the TV to external A/V equipment, match the jack colors (Video = yellow, Audio Left = white, and Audio Right = red).

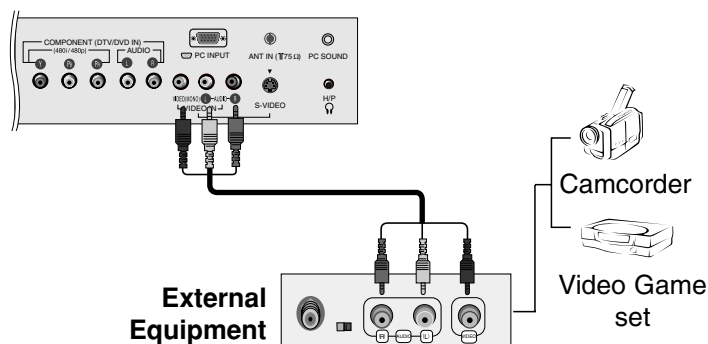

Viewing Setup

1. Turn on the external A/V equipment.
2. Use the **INPUT** button on the remote control to select **Video**.
3. Operate the corresponding external equipment. Refer to external equipment operating guide.

DVD Setup

Connections

1. Connect the DVD video outputs to the COMPONENT (Y, Pb, Pr) jacks and connect the DVD audio outputs to the AUDIO jacks.
2. If your DVD only has an S-Video output jack, connect this to the S-VIDEO input on the TV and connect the DVD audio outputs to the AUDIO INPUT jacks on the TV.

NOTE: If your DVD player does not have component video output, use S-Video.

Viewing Setup

1. Turn on the DVD player, insert a DVD.
2. Use the **INPUT** button on the remote control to select **Component**.
3. Refer to the DVD player's manual for operating instructions. (If connected to S-VIDEO on rear panel, select the **Video** external input source.)

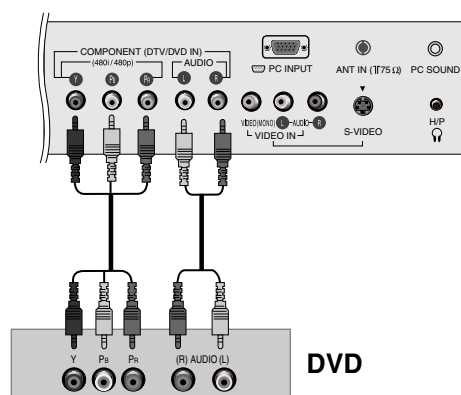

• Component Input ports

To get better picture quality, connect a DVD player to the component input ports as shown below.

Component ports of the TV	Y	P _B	P _R
Video output ports of DVD player	Y	P _b	P _r
	Y	B-Y	R-Y
	Y	C _b	C _r
	Y	P _B	P _R

Model	Signal	Component	RGB-DTV
15LC1R*	480i/480p	Yes	Yes
20LC1R*	480i/480p	Yes	No

DTV Setup

- To watch digitally broadcast programs, purchase and connect a digital set-top box.

Connections

Connect the digital set-top box video outputs to the COMPONENT (Y, PB, PR) jacks and connect the digital set-top box audio outputs to the AUDIO jacks. (or, Connect the set-top box with the D-sub output socket to PC INPUT socket on the set and audio cable of the set-top box to the PC SOUND. (15LC1R*))

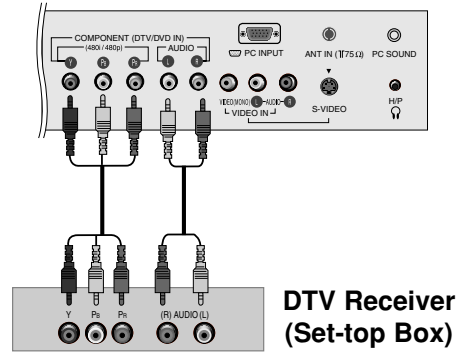

Viewing Setup

1. Turn on the digital set-top box. (Refer to the owner's manual for the digital set-top box.)
2. Use the **INPUT** button on the remote control to select **Component** or **RGB-DTV (15LC1R*)**.

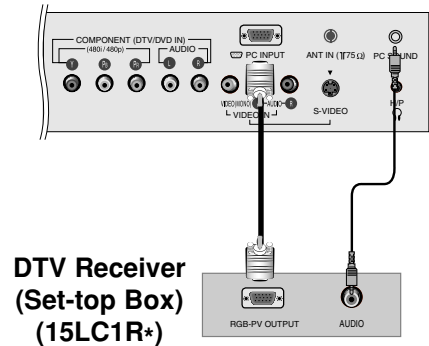

PC Setup (15LC1R* only)

- After setup, be sure to select RGB-PC source on TV.

Connections

1. Set the monitor output resolution on the PC before connecting to the TV.
2. Connect the TV to the PC with the PC cable.
3. Connect the PC audio output to the TV's PC SOUND input.

Viewing Setup

1. Turn on the PC.
2. Use the **INPUT** button on the remote control to select **RGB-PC**.

Monitor Display Specifications

MODE	Resolution	Horizontal Frequency(kHz)	Vertical Frequency(Hz)
VGA	640x480	31.4	60
SVGA	800x600	35.1	56
	800x600	37.8	60
XGA	1024x768	48.3	60

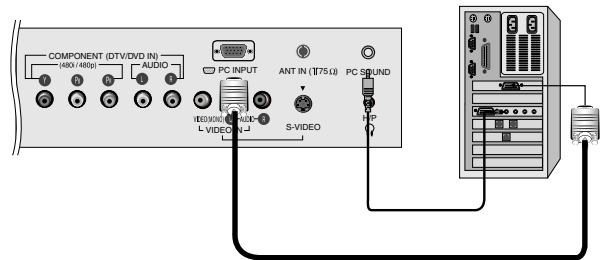

NOTES

- a. For optimum picture quality, use standard 1024x768@60Hz computer output at a 60Hz refresh rate . Using other formats (VGA, SVGA, etc.) or refresh rates may result in reduced picture quality. (To change the computer video output format, please refer to the operating manual for the computer you are using).
- b. If the message "**Out of range**" appears on the screen, adjust the PC output to a format listed in the 'Monitor Display Specifications' chart above.
- c. The synchronization input form for Horizontal and Vertical frequencies is separate.

DPM (Display Power Management) mode

If the PC goes to power saving mode, the monitor automatically switches to DPM mode. If you don't use the PC cable provided, DPM mode may not work.

Operation

TV Operation Overview

1. First, make all equipment connections. Plug the AC Adapter into the TV, then plug the AC Adapter into a power outlet. At this time, the TV is switched to standby mode.
 - In standby mode, press the **POWER, TV, CH (▲, ▼), INPUT** or **number** button on the remote control or **ON/OFF, CH (▲, ▼), INPUT** button located on the TV to turn the TV on.
2. Select the viewing source by pressing **INPUT**.
 - Note: See page 18 if you have not auto programmed the TV to receive channels in your local broadcast area.
3. After viewing, press the **POWER** button on the remote control or **ON/OFF** located on the TV. The TV reverts to standby mode.

NOTE

- If you want to turn the TV off, press the on/off button located on the TV. If you intend to be away on vacation, disconnect the power plug from the wall power outlet.

Menu Language Selection

- The menus can be shown on the screen in the selected language. First select your language.
1. Press the **MENU** button and then use **▲ / ▼** button to select the **SPECIAL** menu.
 2. Press the **▶** button and then use **▲ / ▼** button to select **Language**.
 3. Press the **▶** button and then use **▲ / ▼** button to select your desired language.
From this point on, the on-screen menus will be shown in the language of your choice.
 4. Press the **ENTER** button to save.

Channel Menu Options

Memorizing the Channels with EZ scan

- For Auto program to work, the programming source must be connected to the TV and the TV must be receiving programming signals either over-the-air or from a cable-type service provider.

1. Press the **MENU** button and then use ▲ / ▼ button to select the **CHANNEL** menu.
2. Press the ► button and then use ▲ / ▼ button to select **EZ Scan**.
3. Press the ► button to begin the channel search.
 - Wait for auto program to complete the channel search cycle before choosing a channel. The TV scans for over-the-air channels and then channels provided by a cable service.

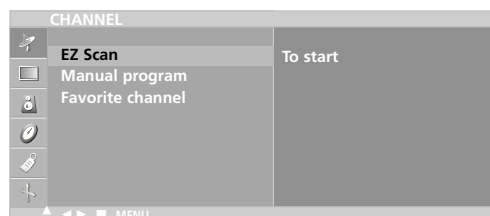

NOTES

- When the channel search is complete, use the ▲ / ▼ buttons to review the memorized channels.
- If you press the **MENU** or **EXIT** button in auto programming, the function will stop and only channels programming up to that time will remain.
- Auto program function can memorize only the channels which are being received at that time.

Add/Delete Channels with Manual Program

- You can manually include or erase individual channels.

1. Press the **MENU** button and then use ▲ / ▼ button to select the **CHANNEL** menu.
2. Press the ► button and then use ▲ / ▼ button to select **Manual program**.
3. Press the ► button and then use ◀ / ▶ button to select a channel you want to add to memory or erase.
4. Press the ▼ button and then use ◀ / ▶ button to select **Memory (add)** or **Erase (delete)**.
5. Press the **ENTER** button to save. The current channel is added to Memory or Erased from the channel list.

The current channel number is displayed.



Adjust frequency with Manual Program

1. Press the **MENU** button and then use ▲ / ▼ button to select the **CHANNEL** menu.
2. Press the ► button and then use ▲ / ▼ button to select **Manual program**.
3. Press the ▼ button to select **Fine** and then use ◀ / ▶ button to adjust frequency from -50 to 50.
4. Press the **ENTER** button to save.

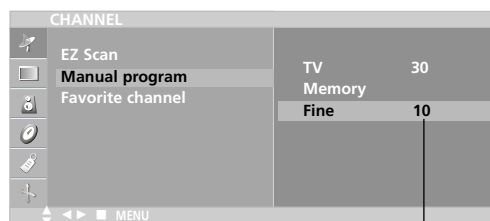

The current frequency is displayed.

Favorite Channels Setup

- Favorite Channel lets you quickly tune in up to 8 channels of your choice without having to wait for the TV to scan through all the in-between channels.



1. Press the **MENU** button and then use ▲ / ▼ button to select the **CHANNEL** menu.
2. Press the ► button and then use ▲ / ▼ button to select **Favorite channel**.
3. Press the ► button and then use ▲ / ▼ button to select the first favorite channel position.
4. Use the ◀ / ▶ button to set the desired channel number for first favorite channel.
5. Repeat steps 3 to 4 to memorize other channels.
6. Press the **ENTER** button to save.
 - To tune to a favorite channel, press the **FAV** button repeatedly. The 8 favorite channels appear on the screen one-by-one.

Picture Menu Options

EZ Video

- This function adjusts the TV for the best picture appearance.

1. Press the **VIDEO** button repeatedly to select the picture appearance setup option as shown below.

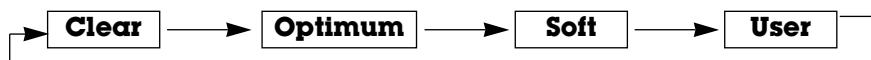

- You can also adjust **EZ Video** in the **PICTURE** menu.
- **Clear, Optimum** and **Soft** are preset for good picture quality at the factory and cannot be changed.

ACC (Auto Color Control)

- Selecting a factory setting colour set.

1. Press the **MENU** button and then use **▲ / ▼** button to select the **PICTURE** menu.
2. Press the **▶** button and then use **▲ / ▼** button to select **ACC**.
3. Press the **▶** button and then use **▲ / ▼** button to select **User**.
4. Press the **▶** button and then **▲ / ▼** button to select a color setting on the **ACC** menu: **Cool, Normal, Warm** or **User (Red, Green, Blue)**.
5. Press the **ENTER** button to save.

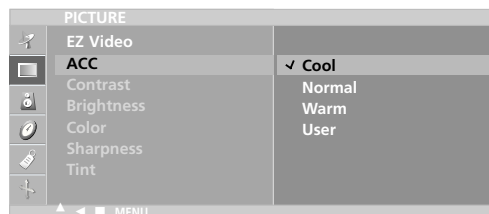

Manual Picture Control

- You can adjust picture contrast, brightness, color, sharpness and tint to the levels you prefer.

1. Press the **MENU** button and then use **▲ / ▼** button to select the **PICTURE** menu.
2. Press the **▶** button and then use **▲ / ▼** button to select **EZ Video**.
3. Press the **▶** button and then use **▲ / ▼** button to select **User** and then press the **◀** button.
4. Use **▲ / ▼** button to select the desired picture option (**Contrast, Brightness, Color, Sharpness, Tint**).
5. Use the **◀ / ▶** button to make appropriate adjustments.
 - Contrast, Brightness, Color, and Sharpness are adjustable from 0 to 100.
 - Tint is adjustable from R 50 to G 50.
6. Press the **ENTER** button to save.

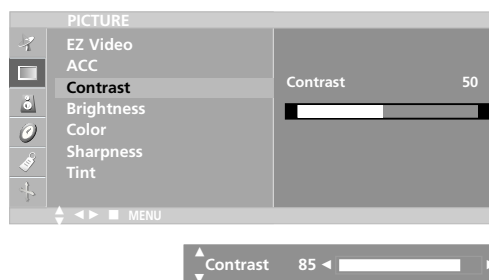

Sound Menu Options

EZ Audio

- This function lets you enjoy the best sound without any special adjustment because the TV selects the appropriate sound option based on the program content.

1. Use the **AUDIO** button to select the appropriate sound setup as shown below.



- You can also adjust **EZ Audio** in the **SOUND** menu.

Equalizer Adjustments

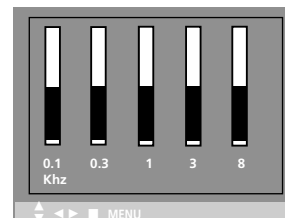
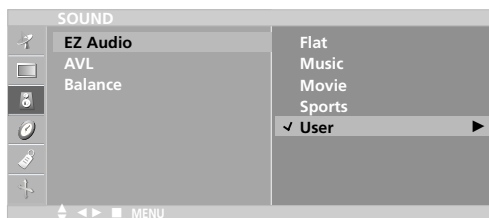

1. Press the **MENU** button and then use **▲ / ▼** button to select the **SOUND** menu.
2. Press the **▶** button and then use **▲ / ▼** button to select **EZ Audio**.
3. Press the **▶** button and then use **▲ / ▼** button to select **User**.
4. Press the **▶** button and then use **◀ / ▶** button to select the band you want to adjust. Then, use **▲ / ▼** button to adjust the band level.
5. Press the **ENTER** button to save.

AVL (Auto Volume Leveler)

- AVL maintains an equal volume level automatically even if the channel is changed.

1. Press the **MENU** button and then use **▲ / ▼** button to select the **SOUND** menu.
2. Press the **▶** button and then use **▲ / ▼** button to select **AVL**.
3. Press the **▶** button and then use **▲ / ▼** button to to select **On** or **Off**.
4. Press the **ENTER** button to save.

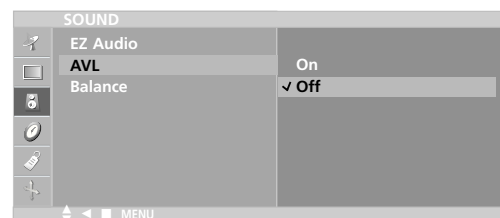

Sound Menu Options continued

Sound Balance

1. Press the **MENU** button and then use ▲ / ▼ button to select the **SOUND** menu.
2. Press the ► button and then use ▲ / ▼ button to select **Balance**.
3. Press the ► button and then use ◀ / ▶ button to adjust the sound balance.
 - Balance is adjustable from Left 50 to Right 50.
4. Press the **ENTER** button to save.

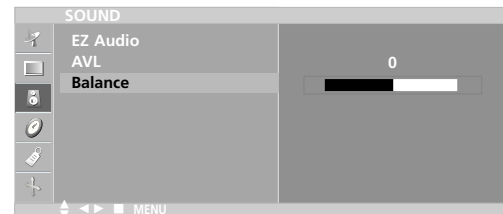

Stereo/SAP Broadcasts Setup

- The TV can receive MTS stereo programs and any SAP (Secondary Audio Program) that accompanies the stereo program, if the broadcaster transmits an additional sound signal as well as the original one.
 - Mono: The primary language is heard from left and right speakers. Signal mode is mono.
 - Stereo: The primary language is heard from left and right speakers. Signal mode is stereo.
 - SAP: The secondary language is heard from left and right speakers.
1. Press the **MTS** button repeatedly.



- Select mono sound mode if the signal is not clear or in poor signal reception areas.
- **Stereo, SAP** mode are available only if included on the broadcast signal.

Timer Menu Options

Auto Clock Setup

- The time is set automatically through from a PBS broadcast signal.
- The PBS channel signal includes information for the correct time and daylight saving time.

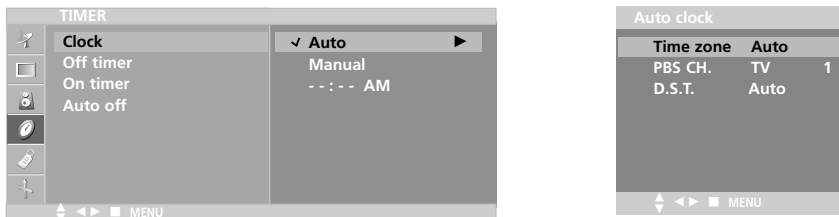

1. Press the **MENU** button and then use **▲ / ▼** button to select the **TIMER** menu.
2. Press the **▶** button and then use **▲ / ▼** button to select **Clock**.
3. Press the **▶** button and then use **▲ / ▼** button to select **Auto**.
4. Press the **▶** button and then use **▲ / ▼** button to select the time zone for your viewing area. Your choices are: **Auto**, **E.S.T. (Eastern Standard Time)**, **C.S.T. (Central Standard Time)**, **M.S.T. (Mountain Standard Time)**, **P.S.T. (Pacific Standard Time)**, **Alaska**, and **Hawaii**.
5. Press the **▶** button and then use **▲ / ▼** button to set **PBS channel**.
6. Press the **▶** button and then use **▲ / ▼** button to set **D.S.T. (Daylight Savings Time) Auto, Off or On**, depending on whether or not your viewing area observes Daylight Savings Time.
7. Press the **ENTER** button to save.

Manual Clock Setup

- If the time on the clock is incorrect, reset the clock manually.

1. Press the **MENU** button and then use **▲ / ▼** button to select the **TIMER** menu.
2. Press the **▶** button and then use **▲ / ▼** button to select **Clock**.
3. Press the **▶** button and then use **▲ / ▼** button to select **Manual**.
4. Press the **▶** button and then use **▲ / ▼** button to set the hour.
5. Press the **▶** button and then use **▲ / ▼** button to set the minutes.
6. Press the **ENTER** button to save.

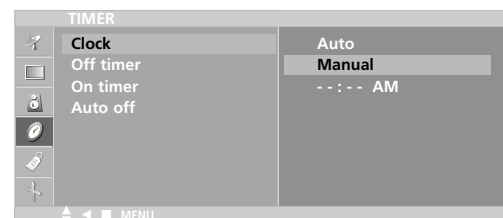

Timer Menu Options continued

On/Off Timer Setup

- Timer function operates only if current time is set.
- Off-Timer function overrides On-Timer function if they are set to the same time.
- The TV must be in standby mode for the On-Timer to work.
- If you don't press any button within 2 hours after turning on the TV with the On-Timer function, the TV will automatically revert to standby mode.

1. Press the **MENU** button and then use ▲ / ▼ button to select the **TIMER** menu.

2. Press the ► button and then use ▲ / ▼ button to select **Off timer** or **On timer**.

3. Press the ► button and then use ▲ / ▼ button to set the hour.

4. Press the ► button and then use ▲ / ▼ button to set the minutes.

5. **For On timer function only:**

Press the ► button and then use ▲ / ▼ button to set the channel at turn-on. Then, press the ► button and then use ▲ / ▼ button to set the turn-on sound level.

6. Press the ► button and then use ▲ / ▼ button to select **On** or **Off**.

- **Off:** **Off timer/On timer** will not work.
- **On:** **Off timer/On timer** are active.

7. Press the **ENTER** button to save.

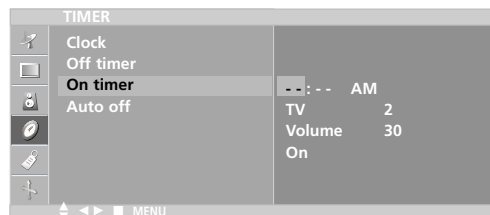

Sleep Timer Setup

- The Sleep Timer turns the TV off at a preset time.

1. Press the **SLEEP** button repeatedly to select the number of minutes. First the '⌚ --- Min.' option appears on the screen, followed by the following sleep timer options: 10, 20, 30, 60, 90, 120, 180, and 240 minutes.

2. When the number of minutes you want is displayed on the screen, press the **ENTER** button. The timer begins to count down from the number of minutes selected.

3. To check the remaining minutes before the TV turns off, press the **SLEEP** button once.

4. To cancel the Sleep Timer, press the **SLEEP** button repeatedly until '⌚ --- Min.' appears.

Auto off

- If Auto off is active and there is no input signal, the TV switches to Standby mode automatically after 10 minutes.

1. Press the **menu** button and then use ▲ / ▼ button to select the **TIMER** menu.

2. Press the ► button and then use ▲ / ▼ button to select **Auto off**.

3. Press the ► button and then use ▲ / ▼ button to select **On** or **Off**.

4. Press the **ENTER** button to save.

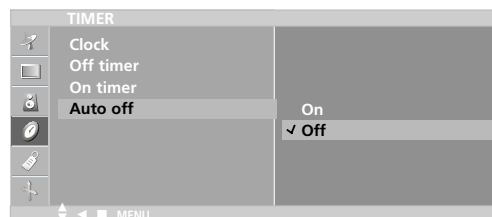

Special Menu Options

Closed Captions

Closed captioning is a process which converts the audio portion of a television program into written words which then appear as subtitles on the television screen. Closed captions allow viewers to read the dialogue and narration of television programs.

Using Closed Captions

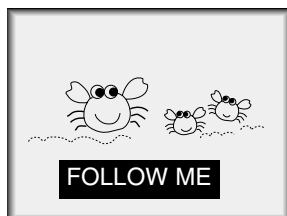

Captions are the subtitles of the dialogue and narration of television programs. For prerecorded programs, program dialogue can be arranged into captions in advance. Its possible to caption a live program by using a process called real-time captioning, which creates captions instantly. Real-time captioning is normally done by professional reporters using a machine shorthand system and computer for translation into English.

Captioning is an effective system for the hearing-impaired, and it can also aid in teaching language skills.

- The picture at left shows a typical caption.

Caption Tips

- Not all TV broadcasts include closed caption signals.
- Sometimes TV stations broadcast four different caption signals on the same channel. By selecting **From CC 1 to CC 4**, you can choose which signal you view. **CC 1** is usually the signal with the captions, while **Another mode** might show demonstration or programming information.
- Your TV might not receive caption signals normally in the following situations.

1. Poor reception conditions are encountered:



- **IGNITION:**

Picture may flutter, drift, suffer from black spots, or horizontal streaking. Usually caused by interference from automobile ignition systems, neon lamps, electrical drills, and other electrical appliances.



- **GHOSTS:**

Ghosts are caused when the TV signal splits and follows two paths. One is the direct path and the other is reflected off tall buildings, hills or other objects. Changing the direction or position of the antenna may improve reception.



- **SNOW:**

If your receiver is located at the weak, fringe area of a TV signal, your picture may be marred by small dots. It may be necessary to install a special antenna to improve the picture.

2. An old, bad, or illegally recorded tape is being played.
3. Strong, random signals from a car or airplane interfere with the TV signal.
4. The signal from the antenna is weak.
5. The program wasn't captioned when it was produced, transmitted, or taped.

Special Menu Options continued

Select Mode

- Inputs can be set for TV, Video or RGB-PC mode. Video mode is used when a video cassette recorder (VCR), or other equipment is connected to the set.

1. Press the **MENU** button and then **▲ / ▼** button to select the **SPECIAL** menu.
2. Press the **▶** button and then **▲ / ▼** button to select **Input**.
3. Press the **▶** button and then **▲ / ▼** button to select **TV, Video, Component, RGB-DTV** or **RGB-PC**.

- **Video:** VCR connected to the **VIDEO IN** socket of the set.
- **Component:** DVD connected to the **COMPONENT** sockets on the back of set.
- **RGB-DTV:** SET TOP connected to the **PC INPUT** and **PC SOUND** socket of the set. (15LC1R*)
- **RGB-PC:** PERSONAL COMPUTER connected to the **PC** socket of the set. (15LC1R*)

4. Press the **ENTER** button to save.



Key lock

- The TV can be set up so that it can only be used with the remote control.
 - This feature can prevent unauthorized viewing.

1. Press the **MENU** button and then use **▲ / ▼** button to select the **SPECIAL** menu.
2. Press the **▶** button and then use **▲ / ▼** button to select **Key lock**.
3. Press the **▶** button and then use **▲ / ▼** button to select **On** or **Off**.
4. Press the **ENTER** button to save.

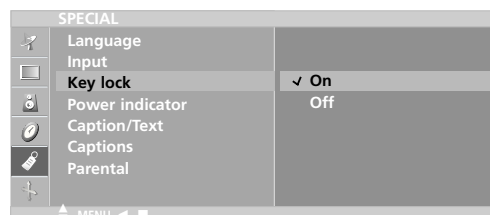

- In **Key lock 'On'**, if the set is turned off, press the **On/Off, CH ▲ / ▼, INPUT** button on the set or **POWER, CH ▲ / ▼, TV, INPUT** or **NUMBER** button on the remote control.

Power indicator

- Use this function to set the power indicator on the front side of the product to **On** or **Off**. If you set **On** at any time, the power indicator will automatically be turned on. Although you select **Off**, set front light turns on for a moment when the set turns on.
1. Press the **MENU** button and then use ▲ / ▼ button to select the **SPECIAL** menu.
 2. Press the ► button and then use ▲ / ▼ button to select **Power indicator**.
 3. Press the ► button and then use ▲ / ▼ button to select **On** or **Off**.
 4. Press the **ENTER** button to save.

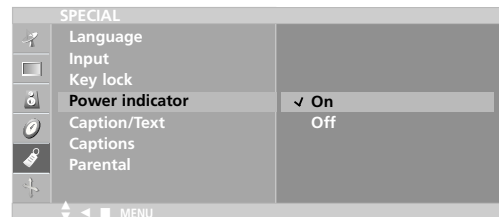

Caption/Text

1. Press the **MENU** button and then use ▲ / ▼ button to select the **SPECIAL** menu.
 2. Press the ► button and then use ▲ / ▼ button to select **Caption/Text**.
 3. Press the ► button and then use ▲ / ▼ button to select caption: **CC1**, **CC2**, **CC3**, **CC4**, **Text1**, **Text2**, **Text3**, or **Text4**.
- **CAPTION**
The term for the words that scroll across the bottom of the TV screen; usually the audio portion of the program provided for the hearing impaired.
 - **TEXT**
The term for the words that appear in a large black frame and almost cover the entire screen; usually messages provided by the broadcaster.
4. Press the **ENTER** button to save.

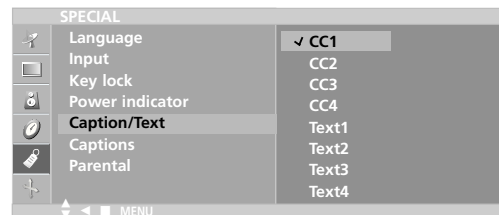

- Use the **CC** button repeatedly to select Caption.

Captions

- Select **On** from **Captions** menu in order to adjust the **Caption/Text** menu.
1. Press the **MENU** button and then use ▲ / ▼ button to select the **SPECIAL** menu.
 2. Press the ► button and then use ▲ / ▼ button to select **Captions**.
 3. Press the ► button and then use ▲ / ▼ button to select **On** or **Off**.
 4. Press the **ENTER** button to save.

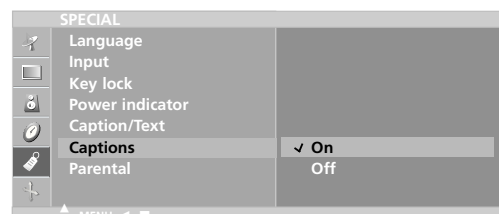

Lock Menu Options

Parental Control can be used to block specific channels, ratings and other viewing sources.

The Parental Control Function (V-Chip) is used to block program viewing based on the ratings sent by the broadcast station. The default setting is to allow all programs to be viewed. Viewing can be blocked by the type of program and by the categories chosen to be blocked. It is also possible to block all program viewing for a time period. To use this function, the following must be set :

1. Ratings and categories to be blocked.
2. Set a password
3. Enable the lock

V-Chip rating and categories

Rating guidelines are provided by broadcast stations. Most television programs and television movies can be blocked by TV Rating and/or Individual Categories. Movies that have been shown at the theaters or direct-to-video movies use the Movie Rating System (MPAA) only.

For Movies previously shown in theaters :

Movie Ratings :

- G and Above (general audience)
- PG and Above (parental guidance suggested)
- PG-13 and Above (13 years and older)
- R and above (restricted)
- NC-17 and Above (18 years and older)
- X (adult)
- Unblocked

If you set PG-13 and Above : G and PG movies will be available , PG-13, R, NC-17 and X will be blocked.

For Television programs including made-for-TV movies:

General TV Ratings:

- TV-G and Above (general audience) (individual categories do not apply)
- TV-PG and Above (parental guidance suggested)
- TV-14 and Above (14 years and older)
- TV-MA (mature audience)
- Unblocked

Children TV Ratings:

- TV-Y and Above (youth) (individual content categories do not apply)
- TV-Y7 (youth, 7 years and up)
- Unblocked

Content Categories:

- Dialog - sexual dialogue (applies to TV-PG and Above, TV-14)
- Language - adult language (applies to TV-PG and Above, TV-14 and Above, TV-MA)
- Sex scenes - sexual situations (applies to TV-PG and Above, TV-14 and Above, TV-MA)
- Violence (applies to TV-PG and Above, TV-14 and Above, TV-MA)
- F Violence - fantasy violence (applies only to TV-Y7)

For Canadian English/French language rating system:

Canadian English language rating system:

- C and Above (Children)
- C8+ (8 years and older)
- G and Above (General programming. Suitable for all audiences.)
- PG and Above (Parental guidance suggested)
- 14+ (Viewer 14 years and older)
- 18+ (Adult programming)
- Unblocked

Canadian French language rating system:

- G and Above (General)
- 8 ans+ (8 years and older)
- 13 ans+ (13 years and older)
- 16 ans+ (16 years and older)
- 18 ans+ (Adults only)
- Unblocked

Lock Menu Setup



1. Press the **MENU** button and then use **▲ / ▼** button to select the **Special** menu.
2. Press the **▶** button and then use **▲ / ▼** button to select **Parental**. Then, press the **▶** button.
 - If **Lock** is already set, enter the password requested.
 - The TV is set with the initial password "0-0-0-0".
2. **Setting Lock on/off:**

Press the **▲ / ▼** button to select **Lock on/off**.

Press the **▶** button and then use **▲ / ▼** button to select **on** or **off**.
3. **Set password:**

Press the **▲ / ▼** button to select **Set password**.

Press the **▶** button and then enter a four digit password.
Enter it again when requested.
4. Press the **▲ / ▼** button to select type of blocking to be set .
5. Press the **▶** button and then use **▲ / ▼** button to select type of ratings to block .
 - **Age block**, and **Content block**, and **Canadian** (option) menus, also have sub menus. So, repeat steps 4 and 5 in the sub menu, to set the types of blocking and ratings .
 - **Aux block** function is not available for use in **Component**, **RGB-DTV**, **RGB-PC** mode.

Screen Menu Options (15LC1R* only)

- After setup, be sure to select RGB-PC source to see the PC image on TV screen.

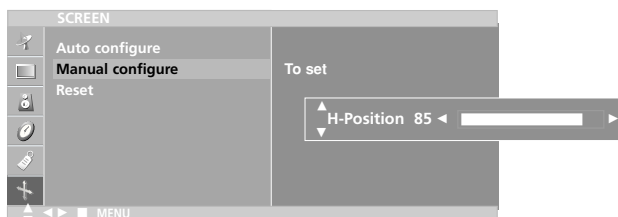

1. Press the **MENU** button and then use ▲ / ▼ button to select the **SCREEN** menu.
2. Press the ► button and then use ▲ / ▼ button to select desired item.
3. Use the ◀ / ▶ button to make appropriate adjustments.
 - H-position/V-position
Adjusts picture left/right and up/down.
The adjustment ranges of H-Position is 0~100.
(Based on the input mode, the adjustment range may change.)
 - Clock
Minimizes any vertical bars or stripes appearing on the screen background.
The adjustment range is 0~100. (Based on the input mode, the adjustment range may change.)
 - Phase
Remove any horizontal noise and clear up or sharpen the character images.
The range adjustment is 0~100. (Based on the input mode, the adjustment range may change.)
 - Auto-configure
Automatically adjusts the screen position, clock, and clock phase.
(The displayed image will disappear for a few seconds while Auto-configuration is in progress.)
 - Reset
Returns to the default settings programmed at the factory; default settings cannot be changed.
4. Press the **ENTER** button to save.

Maintenance

- Early malfunctions can be prevented. Careful and regular cleaning can extend the amount of time you will have your new TV. Be sure to turn the power off and unplug the power cord before you begin any cleaning.

Cleaning the Screen

1. Here's a great way to keep the dust off your screen for a while. Wet a soft cloth in a mixture of lukewarm water and a little fabric softener or dish washing detergent. Wring the cloth until it's almost dry, and then use it to wipe the screen.
2. Make sure the excess water is off the screen, and then let it air-dry before you turn on your TV.

Cleaning the Cabinet

To remove dirt or dust, wipe the cabinet with a soft, dry, lint-free cloth. Please be sure not to use a wet cloth.

Extended Absence



If you leave your TV dormant for a long time (such as a vacation), it's a good idea to unplug the power cord to protect against possible damage from lightning or power surges.

Product Specifications

Power Requirement	15LC1R* : AC100-240V~ 50/60Hz 0.8A 20LC1R* : AC100-240V~ 50/60Hz 1.2A
Power Consumption	15LC1R* : 40W 20LC1R* : 65W
Television System	NTSC
Television Channel	VHF : 2 ~ 13, UHF : 14 ~ 69, Cable : 01 ~ 135
Television Screen	LCD Panel
External Antenna Impedance	75 Ω
Audio Output	15LC1R* : 3W+3W 20LC1R* : 5W+5W

Troubleshooting Checklist

The operation does not work normally.	
The remote control doesn't work	<ul style="list-style-type: none"> • Check to see if there is any object between the product and the remote control causing obstruction. • Are batteries installed with correct polarity (+ to +, - to -)? • Correct remote operating mode set: TV, VCR etc.? • Install new batteries.
Power is suddenly turned off	<ul style="list-style-type: none"> • Is the sleep timer set? • Check the power control settings. Power interrupted • No broadcast on station tuned with Auto off activated.

The video function does not work.	
No picture & No sound	<ul style="list-style-type: none"> • Check whether the product is turned on. • Try another channel. The problem may be with the broadcast. • Is the power cord inserted into wall power outlet? • Check your antenna direction and/or location. • Test the wall power outlet, plug another product's power cord into the outlet where the product's power cord was plugged in.
Picture appears slowly after switching on	<ul style="list-style-type: none"> • This is normal, the image is muted during the product startup process. Please contact your service center, if the picture has not appeared after five minutes.
No or poor color or poor picture	<ul style="list-style-type: none"> • Adjust Color in menu option. • Keep a sufficient distance between the product and the VCR. • Try another channel. The problem may be with the broadcast. • Are the video cables installed properly? • Activate any function to restore the brightness of the picture.
Horizontal/ vertical bars or picture shaking	<ul style="list-style-type: none"> • Check for local interference such as an electrical appliance or power tool.
Poor reception on some channels	<ul style="list-style-type: none"> • Station or cable product experiencing problems, tune to another station. • Station signal is weak, reorient antenna to receive weaker station. • Check for sources of possible interference.
Lines or streaks in pictures	<ul style="list-style-type: none"> • Check antenna (Change the direction of the antenna).

The audio function does not work.	
Picture OK & No sound	<ul style="list-style-type: none"> • Press the VOL (or Volume) button. • Sound muted? Press MUTE button. • Try another channel. The problem may be with the broadcast. • Are the audio cables installed properly?
No output from one of the speakers	<ul style="list-style-type: none"> • Adjust Balance in menu option.
Unusual sound from inside the product	<ul style="list-style-type: none"> • A change in ambient humidity or temperature may result in an unusual noise when the product is turned on or off and does not indicate a fault with the product.

There is a problem in PC mode. (Only PC mode applied)	
The signal is out of range.	<ul style="list-style-type: none"> • Adjust resolution, horizontal frequency, or vertical frequency. • Check it whether the signal cable is connected or loose. • Check the input source.
Vertical bar or stripe on background & Horizontal Noise & Incorrect position	<ul style="list-style-type: none"> • Work the Auto configure or adjust clock, phase, or H/V position. (option)
Screen color is unstable or single color	<ul style="list-style-type: none"> • Check the signal cable. • Reinstall the PC video card.

Note

Note

