



LG Customer Information Center

For inquiries or comments, visit www.lg.com or call:

1-800-243-0000 USA, Consumer User

1-888-865-3026 USA, Commercial User

1-888-542-2623 CANADA

Register your product Online!

www.lg.com



OWNER'S MANUAL

FRIDGE & FREEZER

Read this owner's manual thoroughly before operating the appliance and keep it handy for reference at all times.

EN ENGLISH FR FRANÇAIS ES ESPAÑOL

LBNC10551V
LBNC10551W
LBNC12551V



MFL62883390
Rev.00_042417

www.lg.com

Copyright © 2017 LG Electronics Inc. All Rights Reserved.

TABLE OF CONTENTS

REFRIGERATOR SAFETY	3
IMPORTANT SAFETY INSTRUCTIONS	3
FEATURES CHART	6
INSTALLATION	7
Connection	7
OPERATION	9
Control Panel	9
Temperature Control	9
Express Freeze	9
Vacation Mode	10
Self Test	10
Door Alarm	10
Removal And Installation Of Detachable Glass Shelf	11
Removal And Installation Of Drawer In Refrigeration Compartment.....	11
Removal And Installation Of Drawer In Freezing Compartment.....	12
Ice Preparation.....	12
Freeze Compartment	12
CARE AND MAINTENANCE	13
Foodstuff Storage	13
General	13
During Move	13
Refrigeration Operation Features	14
Anti-Condensation Tube	14
Reversing the Doors(Optional)	14
CLEANING YOUR REFRIGERATOR	15
BEFORE CALLING FOR SERVICE	16
TROUBLESHOOTING	17
SMART DIAGNOSIS(Option)	19
WARRANTY	20

REFRIGERATOR SAFETY

IMPORTANT SAFETY INSTRUCTIONS

READ ALL INSTRUCTIONS BEFORE USING THE APPLIANCE.

This guide contains many important safety messages. Always **read and obey** all safety messages.



This is the safety alert symbol. It alerts you to safety messages that inform you of hazards that can kill or hurt you or others, or cause damage to the product.

All safety messages will be preceded by the safety alert symbol and the hazard signal word WARNING or CAUTION. These words mean:



WARNING You can be killed or seriously injured if you do not follow instructions.



CAUTION Indicates an imminently hazardous situation which, if not avoided, may result in minor or moderate injury, or product damage.



WARNING

To reduce the risk of fire, electric shock, or personal injury when using your product, basic safety precautions should be followed, including the following.

Power

- NEVER unplug your refrigerator by pulling on the power cord. Always grip the plug firmly and pull it straight out from the outlet.
- Immediately repair or replace all power cords that have become frayed or otherwise damaged. Do not use a cord that shows cracks or abrasion damage along its length or at either the plug or connector end.
- Do not use an uncertified power outlet.
- Unplug the power plug immediately in the event of a blackout or thunderstorm.
- Plug in the power plug with the power cord facing downward.

Installation

- Contact an authorized service center when you install or relocate the refrigerator.
- When moving your refrigerator away from the wall, be careful not to roll over or damage the power cord.
- Connect this product to a dedicated grounded electric outlet conforming with the rating prior to use. It is the user's responsibility to replace a standard 2-prong wall outlet with a standard 3-prong wall outlet.
- Do not install the refrigerator where there may be a danger of falling.

Use

- DO NOT allow children to climb, stand, or hang on the refrigerator doors or shelves in the refrigerator. They could damage the refrigerator and seriously injure themselves.
- Do not place heavy objects on the dispenser of the refrigerator or hang onto it.
- Do not place heavy or dangerous objects (bottles with liquid) on the refrigerator.
- Do not put live animals inside of the refrigerator.
- Do not allow children to climb into the product when it is in use.
- In the event of a gas leak (propane/LPG), ventilate sufficiently and contact an authorized service center before use. Do not touch or disassemble the electric outlet of the refrigerator.
- In the event of a refrigerant leak, move flammable objects away from the refrigerator. Ventilate sufficiently and contact an authorized service center.
- Do not use or place flammable substances (chemicals, medicine, cosmetics, etc) near the refrigerator or store them inside the refrigerator. Do not place the refrigerator in the vicinity of flammable gas.

California Proposition 65 (USA only)

- This product contains chemicals known to the State of California to cause cancer and birth defects or other reproductive harm. **Wash hands after handling.**

REFRIGERATOR SAFETY

READ ALL INSTRUCTIONS BEFORE USING THE APPLIANCE.

To reduce the risk of fire, electric shock, or personal injury when using your product, basic safety precautions should be followed, including the following.

- Do not use this product for special purposes (storage of medicine or test materials or for ships, etc).
- Unplug the power plug before cleaning or repairing the refrigerator.
- When you replace the light bulb in the refrigerator, unplug the refrigerator or turn off the power.
- Do not modify or extend the power cord. **Do not use an extension cord.**
- Do not use a dryer to dry the interior. Do not light a candle to remove the interior odor.
- For your safety, this appliance must be properly grounded. Have the wall outlet and the circuit checked by a qualified electrician to make sure the outlet is properly grounded.
- Do not use an outlet that can be turned off with a switch. Do not use an extension cord. It is the user's responsibility to replace a standard 2-prong wall outlet with a standard 3-prong wall outlet.
- Do not, under any circumstances, cut or remove the third (ground) prong from the power cord.
- Do not use an adapter plug and plug the power plug into a multi-outlet extension cord.
- Disconnect the power cord immediately if you hear a noise, smell a strange odor or detect smoke.
- Turn the power off if water or dust penetrates into the refrigerator. Call a service agent.
- Do not disassemble or modify the refrigerator.
- Do not put hands, feet, or metal objects below or behind the refrigerator.
- Do not operate the refrigerator or touch the power cord with wet hands.
- In refrigerators with automatic icemakers, avoid contact with the moving parts of the ejector mechanism or with the heating element that releases the cubes. Do not place fingers or hands on the automatic ice-making mechanism while the refrigerator is plugged in.
- When dispensing ice from the dispenser, do not use crystal ceramics.
- Do not touch the cold surfaces in the freezer compartment with wet or damp hands, when your refrigerator is in operation.
- Do not put glass containers, glass bottles or soda in the freezer.
- This appliance is not intended for use by persons (including children) with reduced physical, sensory or mental capabilities, or lack of experience and knowledge, unless they have been given supervision or instruction concerning the use of the appliance by a person responsible for their safety.
- Do not refreeze frozen food that have thawed completely. It may result in a serious health issue.
- If you are throwing away your old refrigerator, make sure the CFC coolant is removed for proper disposal by a qualified servicer. If you release CFC coolant, you may be fined or imprisoned in accordance with the relevant environmental law.
- Junked or abandoned refrigerators are dangerous, even if they are sitting for only a few days. When disposing the refrigerator, remove the packing materials from the door or take off the doors but leave the shelves in place so that children may not easily climb inside.

REFRIGERATOR SAFETY

READ ALL INSTRUCTIONS BEFORE USING THE APPLIANCE.

To reduce the risk of fire, electric shock, or personal injury when using your product, basic safety precautions should be followed, including the following.

CAUTION

Installation

- Be careful when you unpack and install the refrigerator. Immediately dispose of packing materials (plastic) out of reach of children.

Use

- Close the door carefully when children are around.
- Keep fingers out of pinch point areas; clearances between the doors and cabinets are necessarily small. Be careful closing doors when children are in the area.
- If you store food properly, beware that it may fall and cause injury.

Maintenance

- Do not use strong detergents like wax or thinners for cleaning. Clean with a soft fabric.
- Wipe foreign objects (dust, water, etc) off the prongs of the power plug and contact areas regularly.

- This appliance is intended to be used in household and similar applications such as staff kitchen areas in shops, offices and other working environments; farm houses and by clients in hotels, motels and other residential environments; bed and breakfast environments; catering and similar non-retail applications.
- Do not store explosive substances such as aerosol cans with a flammable propellant in this appliance.

DISPOSAL

- **Junked or abandoned refrigerators are dangerous, even if they are sitting for only a few days.**

When disposing of the refrigerator, remove the packing materials from the door or take off the doors but leave the shelves in place so that children may not easily climb inside.

Supply Cord Replacement

If the supply cord is damaged, it must be replaced by the manufacturer or its service agent or a similarly qualified person in order to avoid a hazard.

ENGLISH

SAVE THESE INSTRUCTIONS

FEATURES CHART

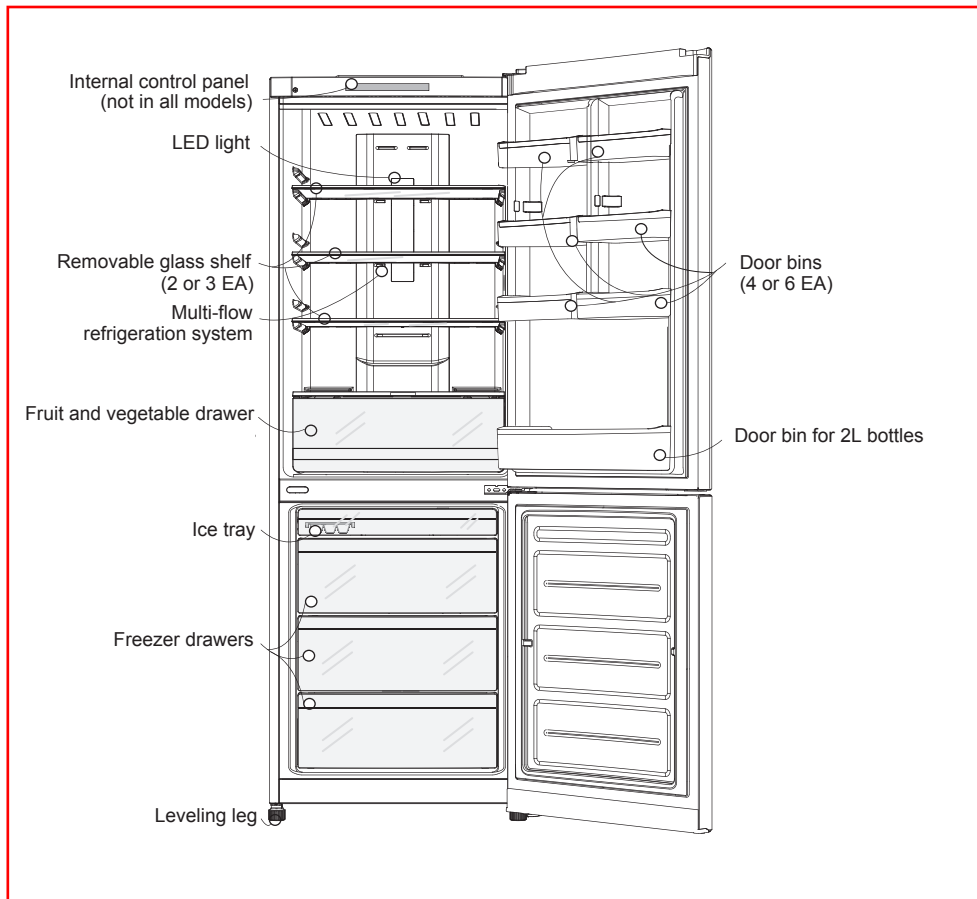

Note

The parts shown may vary depending on the model.

INSTALLATION

CONNECTION

- Choose the suitable place. Locate the refrigerator in a place convenient for its use;
- This is a freestanding refrigerator and requires a minimum of 2 inches (5 cm) clearance above, behind, and at both sides for adequate air circulation and to reduce energy consumption
- Do not install the refrigerator near heat sources and in a zone exposed to direct sunlight or high humidity;
- Make sure that electrical voltage indicated in the manual meets the parameters of your mains;
- Do not remove the round stickers on the rear side of the refrigerator. They have a decorative function closing the fabrication holes;
- To exclude vibration, check the refrigerator installation using a level. If necessary, turn the adjustable feet to compensate irregularity of the floor.
To ensure better closing of the door, the refrigerator should be slightly inclined backwards. To turn the adjustable feet, slightly incline the refrigerator.
- Before use, carefully wash the refrigerator;
- Install the removable parts, such as ice tray, etc. to the appropriate places.
It is necessary to prevent possible damages during transportation;
- Insert the power cord plug to the power outlet. Do not power other electric appliance from the same outlet.

After first installation of the refrigerator, let it work for 2-3 hours for stabilization of the operating temperature inside and only then fill the refrigerator with fresh or frozen foodstuffs. After disconnection of the refrigerator from the mains, wait at least 5 minutes to switch on it again. Now, the refrigerator is ready for service.

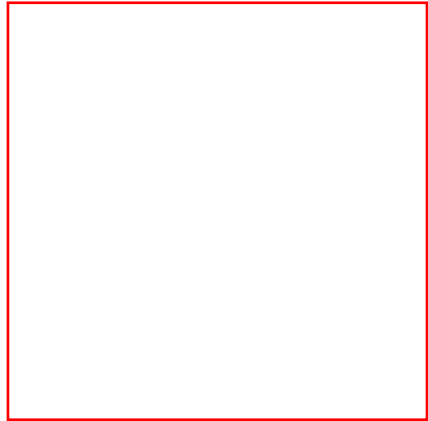

INSTALLATION

Dimensions and Clearances

- Check the dimensions of the appliance and the installation path to ensure there is sufficient room to move the refrigerator through doors or narrow openings.
- If an opening is too narrow to fit the refrigerator through, remove the refrigerator doors. See Removing/Assembling the Doors and Drawers in this manual.
- The installation location chosen for the refrigerator should allow space behind the unit for connections and airflow and space in front to open the doors and drawers.
- Too small of a distance from adjacent items may result in lowered freezing capability and increased electricity consumption charges. Allow at least 29 4/5 inches (758 mm) in front of the refrigerator to open the doors, and at least 2 inches (50 mm) between the back of the refrigerator and the wall.

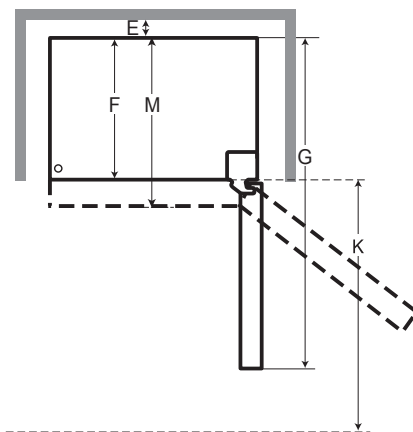
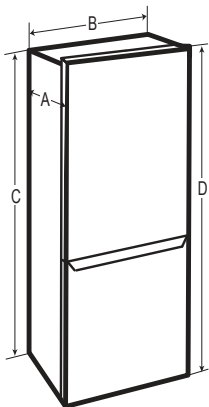

-	List	LBNC10551V LBNC10551W	LBNC12551V
A	Depth without handle	25 3/8" (643 mm)	25 3/8" (643 mm)
B	Width	23 1/2" (595 mm)	23 1/2" (595 mm)
C	Height to Top of Case	67 4/5" (1722 mm)	74 1/2" (1892 mm)
D	Height to Top of Hinge	68 3/8" (1737 mm)	75 1/8" (1907 mm)
E	Back Clearance	2" (50 mm)	2" (50 mm)
F	Depth without Door	21 9/10" (556 mm)	21 9/10" (556 mm)
G	Depth (Total with Door Open 90°)	45 3/5" (1158 mm)	45 3/5" (1158 mm)
K	Front Clearance	29 4/5" (758 mm)	29 4/5" (758 mm)
M	Depth with handle	25 3/8" (643 mm)	25 3/8" (643 mm)

OPERATION

CONTROL PANEL

Internal display

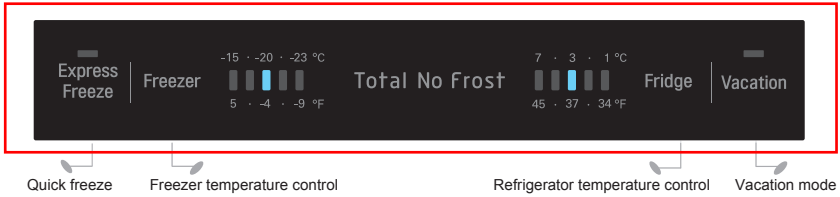

TEMPERATURE CONTROL

The initial temperature in the refrigerator and freezer compartments is 3 °C(37 °F) and -20 °C(-4 °F), respectively.

To change the temperature settings, press the temperature control button for the appropriate compartment.

Internal LED display

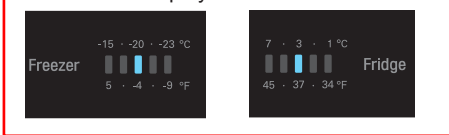

NOTE: The displayed temperature is the target temperature only. The actual internal temperature of the refrigerator depends on the amount and type of food stored inside.

After initial installation, allow the temperature settings to stabilize for at least 2 to 3 days before adjusting them.

EXPRESS FREEZE

- This function increases both icemaking and freezing capabilities.
- Press the button to turn on the Express Freeze function and the indicator light for 24 hours.
- After 24 hours, the Express Freeze function and the indicator light turn off. The freezer returns to the previously set temperature. Press the Express Freeze button at any time while the function is running to manually turn it off.



- The Express Freeze indicator remains lit as long as the function is running.

OPERATION

Vacation Mode

Use the Vacation Mode function when you will be away from home for an extended period. Push the Vacation Mode button to turn the function on or off. The LED lights up when the function is active.

Internal LED display

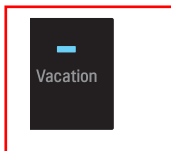

NOTE

Vacation Mode deactivates the other controls. Press Vacation Mode to cancel the function and return to the previously set temperature.

SELF-TEST

The display has a self-test function.

If the refrigerator has a failure, the buttons become inoperative and the indicator shows the error code.

In this case, do not switch off power and immediately contact the local service center. If you switch off the refrigerator, a service engineer may need much time to find the faulty element.

DOOR ALARM

- When the refrigerator door is opened for more than 60 seconds, the alarm tone will sound to let you know that the door is opened.
- When you close the door ,the door alarm will stop.
- If the alarm continues to sound even after closure of the door, contact the service center.

OPERATION

REMOVAL AND INSTALLATION OF DETACHABLE GLASS SHELF

To remove a refrigerator shelf, raise the front of the shelf slightly (1) and pull the shelf forward (2). Take care when removing the shelf to avoid damage to the product.

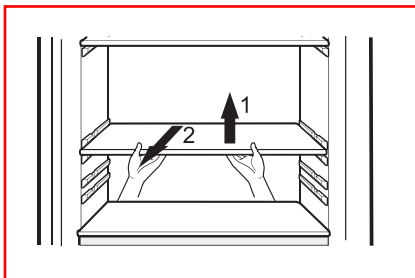

To install a refrigerator shelf, tilt the shelf up at the front and insert it into the refrigerator at the desired location (3). Then push the shelf back (4). Take care when installing the shelf to avoid damage to the product.

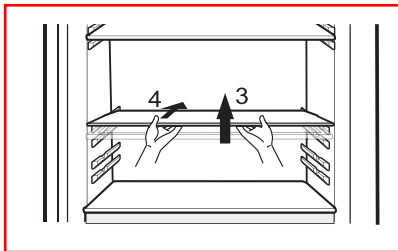

REMOVAL AND INSTALLATION OF DRAWER IN REFRIGERATOR COMPARTMENT

To remove the lower drawer from the refrigerator compartment, proceed as follows:

- Lift up and remove the lowest door bin.
- Pull the drawer out as far as possible, lift the front, and remove the drawer completely.

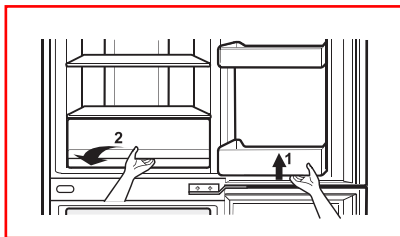

- Lift the front of the drawer cover and pull to remove it.

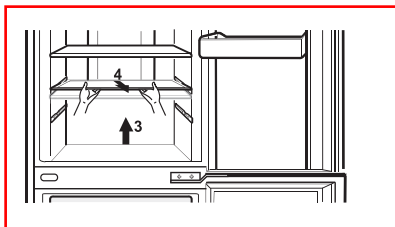

- To install the drawer, follow the removal instructions in reverse.

CAUTION

At that, you should take care to exclude slant. Improper removal and installation may result in damage of internal parts in the refrigerator.

NOTE

The guarantee does not cover mechanical damages (cracks, shears, dents, traces of enclosure opening, etc.) caused by violation of the refrigerator storage, transportation, operation, and maintenance rules, application of excessive force.

OPERATION

REMOVAL AND INSTALLATION OF DRAWERS IN FREEZER COMPARTMENT

When freezing a large quantity of food, remove the middle freezer drawer to increase the available storage space.

To remove any freezer drawer, proceed as follows:

1. Pull the drawer all the way out;
2. Raise the front of the drawer and pull to remove the drawer completely.



To install any freezer drawer:

1. Place the drawer onto the guides at a 45° angle.
2. Lower the front of the drawer so it is parallel to the drawer guides.
3. Push the drawer all the way in.

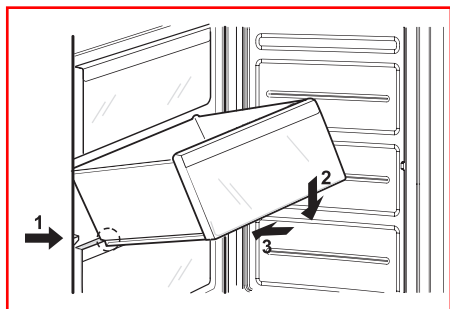

⚠ CAUTION

Do not apply excessive force to remove the drawers and shelves – this may result in damage to the refrigerator.

ICE PREPARATION

Fill the ice tray with water and place it to the freezing compartment.



If ice cubes are required as soon as possible, activate the "Express Freeze" function.

To remove ice cubes, hold the tray on ends and slightly bend it.



⚠ WARNING!

Fill with potable water only.

ADVICE

To easily remove cubes, water the tray in advance.

Freezer Storage Options

When storing large quantities of food in the freezer, remove the middle freezer drawer and place food directly on the wire shelf to maximize food storage capacity. Use the drawer to store food or containers that might spill or leak.



CARE AND MAINTENANCE

FOODSTUFF STORAGE

- Do not store food which goes bad easily at low temperature, such as banana, and melon.
- Allow hot food to cool prior to storing. Placing hot food in the fridge-freezer could spoil other food, and lead to higher electric bills.
- When storing the food, use a container with a lid. This prevents moisture from evaporating, and helps food to keep its taste and nutrients.
- Do not block air vents with food. Smooth circulation of cold air keeps fridge-freezer temperature even.
- Do not open the door frequently. Opening the door lets warm air enter the fridge-freezer, and cause temperature to rise.
- To adjust the temperature control easily, do not store food near the temperature control dial.
- Never keep too many foods in door rack, as this may stop the door from fully closing.
- Do not store bottles in the freezer compartment - they may break when frozen.
- Do not refreeze food that has been thawed. This causes loss of taste and nutrition.
- If it is necessary to quickly freeze fresh foodstuffs, place them to the lower drawer of the freezing compartment and push the "Express Freeze " button;
- Frozen foodstuffs should be stored packed (in polyethylene film, aluminum foil, etc.) in the freezing compartment;

CLEANING

1. Before cleaning, make sure that power supply is switched off;
2. Outside and inside, the refrigerator should be washed with a clean napkin wetted in warm water with a liquid detergent. Then wipe dry with a dry napkin;
3. After cleaning, make sure that the power cord is not damaged. Then tightly insert the plug to the power outlet.

CAUTION

1. It is prohibited to use abrasive materials, gasoline, benzene, solvents, hydrochloride, hot water, hard brushes, etc., which may damage the refrigerator surface.
2. For products with a stainless steel exterior, use a clean sponge or soft cloth and a mild Detergent in warm water. Do not use abrasive or harsh cleaners. Dry thoroughly with a Soft cloth. Do not use appliance wax, bleach, or other products containing chlorine on stainless steel.

GENERAL

Electric power failure.

- An interruption in electric power supply for 1-2 hours will not harm the stored foodstuffs. Try to less frequently open and close the refrigerator door during this period.

DURING MOVE:

- Remove all foodstuffs and other objects from the refrigerator. Firmly secure the internal detachable parts (shelves, drawers, door baskets);
- To avoid damage of the floor and adjustable feet of the refrigerator, turn them counter-clockwise before transportation;
- The refrigerator should be firmly secured in the truck to prevent its hits and falling inside the truck during transportation;
- The refrigerator should be transported in vertical position in a covered vehicle. The original package should not be damaged during transportation;
- During loading and unloading, the refrigerator should be protected against hits.

CARE AND MAINTENANCE

BEFORE SWITCHING ON:

- If the refrigerator is transported in cold season, unpack the refrigerator in a warm room and do not switch on it for at least 12 hours.

NOTE

If you keep the fridge-freezer in a hot, and humid place, frequently opening the door or putting a lot of vegetables in it may cause condensation to form.

This has no effect on its performance.

Remove the condensation with a dry, dust-free cloth.

If droplets form beneath the cover of the vegetable drawer, keep vegetables or fruits wrapped with plastic wrap.

⚠ CAUTION

Do not move or incline the refrigerator during its operation.

Noise may occur in the compressor.

This feature does not affect operability of the compressor.

REFRIGERATOR OPERATION FEATURES

Cracking noise may be heard due to thermal deformations of the refrigerator components.

Typical sounds from activation of the thermostatic controller and compressor are normal sounds occurring during operation of electric equipment in the appliance.

The refrigerant circulating inside the refrigeration system may calmly gurgle, even if the compressor is idle.

Do not worry, this is absolutely normal.

The following sounds may be heard during operation of the refrigerator:

- Clicks from actuation of the temperature sensor/switch;
- Murmur of the refrigerant circulating in tubes of the refrigeration system;
- Slight cracking noise from thermal deformations of materials.

These sounds are not associated with any defect and they have a functional aspect.

ANTI-CONDENSATION TUBE:

- The anti-condensation tube is laid inside the enclosure around the front face of the refrigerator to exclude moisture condensation;
- The refrigerator may greatly heat up in these places, especially immediately after switching on for the first time or at high ambient temperature.

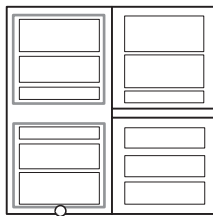

Anti-condensation tube

⚠ CAUTION

- Dry ice is very cold! Do not allow it to touch bare skin. It is well below °F and will cause immediate frostbite and damage to the skin and other tissue.
- Dry ice frozen carbon dioxide. Use only in a well ventilated area. As the ice releases carbon dioxide vapor, it could cause light-headedness, fainting, suffocation, or death.

Reversing the Door (Optional)

- Your fridge-freezer is designed with reversible doors that can be installed to open from either the left or the right to fit the installation location.

⚠ CAUTION

The doors must be reversed by an authorized installer or service person. Service calls to reverse doors are not covered by the warranty.

CLEANING YOUR REFRIGERATOR

WARNING



Explosion Hazard

Use nonflammable cleaner.

Failure to do so can result in death, explosion, or fire.

Both the refrigerator and freezer sections defrost automatically. However, clean both sections about once a month to prevent odors from building up. Wipe up spills immediately.

To clean your refrigerator.

- Unplug refrigerator or disconnect power.
- Remove all removable parts from inside, such as shelves, crispers, etc.
- Use a clean sponge or soft cloth and a mild detergent in warm water. Do not use abrasive or harsh cleaners.
- Hand wash, rinse, and dry all surfaces thoroughly.
- Plug in refrigerator or reconnect power.

■ Additional cleaning tips are listed below:

PART	COMMENTS
Outside	<ul style="list-style-type: none">■ Waxing external painted metal surfaces helps provide rust protection. Do not wax plastic parts. Wax painted metal surfaces at least twice a year using appliance wax (or auto paste wax). Apply wax with a clean, soft cloth.■ For products with a stainless steel exterior, use a clean sponge or soft cloth and a mild detergent in warm water. Do not use abrasive or harsh cleaners. Dry thoroughly with a soft cloth.
Inside walls (allow freezer to warm up so cloth won't stick)	<ul style="list-style-type: none">■ To help remove odors, you can wash the inside of the refrigerator with a mixture of baking soda and warm water. Mix 2 tablespoons soda to 1 quart of water (26 g soda to 1 liter water.) Be sure the soda is completely dissolved so it is not abrasive and doesn't scratch the surfaces of the refrigerator.
Door liners and gaskets	<ul style="list-style-type: none">■ Do not use cleaning waxes, concentrated detergents, bleaches, or cleaners containing petroleum on plastic parts.
Plastic parts (covers and panels)	<ul style="list-style-type: none">■ Do not use paper towels, window sprays, abrasive cleansers, or flammable fluids. These can scratch or damage material.
Condenser coils	<ul style="list-style-type: none">■ Remove base grille. (See the Base grille section on page 6.)■ Use a vacuum with an extended attachment to clean condenser coils.■ Vacuum coils when dusty or dirty. Coils may need to be cleaned as often as every other month.■ Replace base grille.

BEFORE CALLING FOR SERVICE

SERVICE CALLS CAN OFTEN BE AVOIDED!

IF YOU FEEL YOUR REFRIGERATOR IS NOT OPERATING PROPERLY, CHECK THESE POSSIBLE CAUSES FIRST:

PROBLEM	POSSIBLE CAUSES
REFRIGERATOR DOES NOT OPERATE	<ul style="list-style-type: none">■ Has a house fuse blown or circuit breaker tripped?■ Has the power cord plug been removed or loosened from the electrical wall outlet?
REFRIGERATOR OR FREEZER COMPARTMENT TEMPERATURE TOO WARM	<ul style="list-style-type: none">■ Temperature control not set on proper position.■ Appliance is placed close to wall or heat source.■ Warm weather-frequent door openings.■ Door is not closed entirely.■ Door left open for a long time.■ Large amount of foods are kept in the refrigerator.
ABNORMAL NOISE(S)	<ul style="list-style-type: none">■ Refrigerator is installed in a weak or uneven place or leveling screw needs adjusting.■ Unnecessary objects placed in the back side of the refrigerator.
REFRIGERATOR HAS ODOR	<ul style="list-style-type: none">■ Foods with strong odors should be tightly covered or wrapped.■ Interior needs cleaning.
DEW FORMS ON THE CABINET SURFACE	<ul style="list-style-type: none">■ Not unusual during periods of high humidity.■ Door may have been left ajar.

Customer Assistance Numbers:

- To Prove Warranty Coverage
Retain your Sales Receipt to prove date of purchase.
A copy of your Sales Receipt must be submitted at the time warranty service is provided.
- To Obtain Product, Customer or Service Assistance
Call Toll-free for Customer Service
Tel : 1-888-542-2623 (1-888-LG-CANADA)
- To Obtain Nearest Authorized Service Center
Call 1-888-542-2623, push option #1, 24 hours a day, 7days per week.
Please have your product type (Monitor, TV, VCR, MWO, Refrigerator) and ZIP code ready.

TROUBLE SHOOTING

PROBLEM	POSSIBLE CAUSES
REFRIGERATOR-FREEZER DOES NOT OPERATE	<ul style="list-style-type: none">■ Power plug may be unplugged from the electric outlet. Plug it in securely.■ House fuse has blown or circuit breaker has tripped. Check and/or replace fuse and reset circuit breaker.■ Power cut. Check house lights.
REFRIGERATOR OR FREEZER COMPARTMENT TEMPERATURE TOO WARM	<ul style="list-style-type: none">■ Temperature control not set on proper position. Refer to Temperature Control section.■ Appliance is placed close to heat source.■ Warm weather-frequent door openings.■ Door left open for a long time.■ Package holding door open or blocking air duct in freezer compartment.
VIBRATION OR RATTLING OR ABNORMAL NOISE	<ul style="list-style-type: none">■ The floor on which the Refrigerator-Freezer is installed may be uneven or the Refrigerator-Freezer may be unstable. Make it even by rotating the leveling screw.■ Unnecessary objects placed in the back side of the Refrigerator-Freezer.
FROST OR ICE CRYSTALS ON FROZEN FOOD	<ul style="list-style-type: none">■ Door may have been left ajar or package holding door open.■ Too frequent or too long door openings.■ Frost within package is normal.
MOISTURE FORMS ON CABINET SURFACE	<ul style="list-style-type: none">■ This phenomenon is likely to occur in a wet space. Wipe it with a dry towel.
MOISTURE COLLECTS INSIDE	<ul style="list-style-type: none">■ Too frequent or too long door openings.■ In humid weather, air carries moisture into refrigerator when doors are opened.

TROUBLE SHOOTING

PROBLEM	POSSIBLE CAUSES
REFRIGERATOR HAS ODOR	<ul style="list-style-type: none">■ Foods with strong odors should be tightly covered or wrapped.■ Check for spoiled food.■ Interior needs cleaning. Refer to CLEANING section
DOOR NOT CLOSING PROPERLY	<ul style="list-style-type: none">■ Food package is keeping door open. Move packages that keep door from closing.■ Refrigerator-Freezer is not level. Adjust the leveling screws.■ The floor on which the Refrigerator-Freezer is installed may be uneven or the Refrigerator-Freezer may be unstable. Slightly raise the front side with the leveling screw.
INTERIOR LIGHT DOES NOT WORK	<ul style="list-style-type: none">■ No power at outlet.■ Light lamp needs replacing. If LED lamp is damaged, it should be replaced by the service center instead of on your own.

SMART DIAGNOSIS(Option)

SMART DIAGNOSIS

Should you experience any problems with your refrigerator, it has the capability of transmitting data via your telephone to the LG service center. This gives you the capability of speaking directly to our trained specialists. The specialist records the data transmitted from your machine and uses it to analyze the issue, providing a fast and effective diagnosis.

If you experience problems with your refrigerator, call the phone No. of LG Customer Information Center. Only use the Smart Diagnosis feature when instructed to do so by the LG call center agent. The transmission sounds that you will hear are normal and sound similar to a fax machine.

Smart Diagnosis cannot be activated unless your refrigerator is connected to power. If your refrigerator is unable to turn on, then troubleshooting must be done without using Smart Diagnosis.

Using Smart Diagnosis

First, call the LG Customer Information Center. Only use the Smart Diagnosis feature when instructed to do so by the LG call center agent.

- 1 Open the refrigerator door.
- 2 Hold the mouthpiece of your phone in front of the speaker that is located on the right hinge of the refrigerator door, when instructed to do so by the call center.

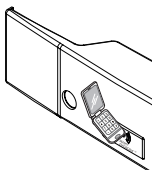

- 3 Press and hold the Freezer temperature button for three seconds while continuing to hold your phone to the speaker.

Freezer

- 4 After you hear three beeps, release the Freezer temperature button.
- 5 Keep the phone in place until the tone transmission has finished. The display will count down the time. Once the countdown is over and the tones have stopped, resume your conversation with the specialist, who will then be able to assist you in using the information transmitted for analysis.

NOTE

- For best results, do not move the phone while the tones are being transmitted.
- If the call center agent is not able to get an accurate recording of the data, you may be asked to try again.

NOTE

- Call quality differences by region may affect the Smart Diagnosis function.
- For best results, use a landline phone.
- Bad call quality may result in poor data transmission from your phone to the machine, which could prevent Smart Diagnosis from working properly.

ENGLISH

WARRANTY

WARRANTY (USA)

WARRANTY: Should your LG Refrigerator ("Product") fail due to a defect in materials or workmanship under normal home use, during the warranty period set forth below, LG will at its option repair or replace the product. This limited warranty is valid only to the original retail purchaser of the product and applies only when purchased and used within the United States including U.S. Territories. Proof of original retail purchase is required to obtain warranty service under this limited warranty.

WARRANTY PERIOD			
Refrigerator	Sealed System (Condenser, Dryer, Connecting Tube and Evaporator)		Linear Compressor
One (1) year from the date of original retail purchase	One (1) year from the date of original retail purchase	Seven (7) years from the date of original retail purchase	Ten (10) years from the date of original retail purchase
Parts and Labor (internal/functional parts only)	Parts and Labor	Parts only (Consumer will be charged for labor)	Part only (Consumer will be charged for labor)

Noises associated with normal operation and failure to follow instructions found in the use and care and installation guides or operating the unit in an unsuitable environment will not be covered under this warranty.

- Replacement products and parts are warranted for the remaining portion of the original warranty period or ninety (90) days, whichever is greater.
- Replacement products and parts may be new or remanufactured.

THIS WARRANTY IS IN LIEU OF ANY OTHER WARRANTY, EXPRESS OR IMPLIED, INCLUDING WITHOUT LIMITATION, ANY WARRANTY OF MERCHANTABILITY OR FITNESS FOR A PARTICULAR PURPOSE. TO THE EXTENT ANY IMPLIED WARRANTY IS REQUIRED BY LAW, IT IS LIMITED IN DURATION TO THE EXPRESS WARRANTY PERIOD ABOVE. NEITHER THE MANUFACTURER NOR ITS U.S. DISTRIBUTOR SHALL BE LIABLE FOR ANY INCIDENTAL, CONSEQUENTIAL, INDIRECT, SPECIAL, OR PUNITIVE DAMAGES OF ANY NATURE, INCLUDING WITHOUT LIMITATION, LOST REVENUES OR PROFITS, OR ANY OTHER DAMAGE WHETHER BASED IN CONTRACT, TORT, OR OTHERWISE.

Some states do not allow the exclusion or limitation of incidental or consequential damages or limitations on how long an implied warranty lasts, so the above exclusion or limitation may not apply to you. This warranty gives you specific legal rights and you may also have other rights that vary from state to state.

THIS LIMITED WARRANTY DOES NOT COVER:

- Service trips to deliver, pick up, or install or repair the product; instruction to the customer on operation of the product; repair or replacement of fuses or correction of wiring or plumbing, or correction of unauthorized repairs/installation.
- Failure of the product to perform during power failures and interrupted or inadequate electrical service.
- Damage caused by leaky or broken water pipes, frozen water pipes, restricted drain lines, inadequate or interrupted water supply or inadequate supply of air.
- Damage resulting from operating the product in a corrosive atmosphere or contrary to the instructions outlined in the product's owner's manual.
- Damage to the product caused by accidents, pests and vermin, lightning, wind, fire, floods, or acts of God.
- Damage resulting from misuse, abuse, improper installation, repair, or maintenance. Improper repair includes use of parts not approved or specified by LG.
- Damage or failure caused by unauthorized modification or alteration, or if it is used for other than the intended purpose, or any water leakage where the unit was not properly installed.

WARRANTY

- Damage or failure caused by incorrect electrical current, voltage, or plumbing codes, commercial or industrial use, or use of accessories, components, or consumable cleaning products that are not approved by LG.
- Damage caused by transportation and handling, including scratches, dents, chips, and/or other damage to the finish of your product, unless such damage results from defects in materials or workmanship and is reported within one (1) week of delivery.
- Damage or missing items to any display, open box, discounted, or refurbished product.
- Products with original serial numbers that have been removed, altered, or cannot be readily determined. Model and serial numbers, along with original retail sales receipts, are required for warranty validation.
- Increases in utility costs and additional utility expenses.
- Replacement of light bulbs, filters, or any consumable parts.
- Repairs when your product is used for other than normal and usual household use (e.g. commercial use, in offices and recreational facilities) or contrary to the instructions outlined in the product's owner's manual.
- Costs associated with removal of your product from your home for repairs.
- The removal and reinstallation of the product if it is installed in an inaccessible location or is not installed in accordance with published installation instructions, including LG's owner's and installation manuals.
- Shelves, door bins, drawers, handles, accessories, and other parts besides those that were originally included with this particular model.

The cost of repair or replacement under these excluded circumstances shall be borne by the consumer.

TO OBTAIN WARRANTY SERVICE AND ADDITIONAL INFORMATION

For additional product information, visit the LG website at <http://www.lg.com>

For assistance using this product or to schedule service, contact LG Electronics at 1-800-243-0000.

For further assistance, write: LG Electronics, 201 James Record Road, Huntsville, Alabama 35813

WARRANTY

WARRANTY (CANADA)

WARRANTY: Should your LG Refrigerator ("Product") fail due to a defect in material or workmanship under normal home use during the warranty period set forth below, LG Canada will at its option repair or replace the Product upon receipt of proof of original retail purchase. This warranty is valid only to the original retail purchaser of the product and applies only to a Product distributed in Canada by LG Canada or an authorized Canadian distributor thereof. The warranty only applies to Products located and used within Canada. Coverage for "in Home" repairs, for products in-warranty, will be provided if the Product is within a 150 km radius from the nearest authorized service center (ASC), as determined by LG Canada. If your Product is located outside a 150 km radius from a ASC, as determined by LG Canada, it will be your responsibility to bring the Product, at your sole expense, to the ASC for in-warranty repair.

WARRANTY PERIOD

Refrigerator	Sealed System (Condenser, Dryer, Connecting Tube and Evaporator)		Linear Compressor
One (1) year from the date of original retail purchase	One (1) year from the date of original retail purchase	Seven (7) years from the date of original retail purchase	Ten (10) years from the date of original retail purchase
Parts and Labor (internal/functional parts only)	Parts and Labor	Parts only (Consumer will be charged for labor)	Part only (Consumer will be charged for labor)

Noises associated with normal operation and failure to follow instructions found in the use and care and installation guides or operating the unit in an unsuitable environment will not be covered under this warranty.

- Replacement products and parts are warranted for the remaining portion of the original warranty period or ninety (90) days, whichever is greater.
- Replacement products and parts may be new or remanufactured.
- LG Authorized Service Center warranties their repair work for thirty (30) days.

LG CANADA'S SOLE LIABILITY IS LIMITED TO THE WARRANTY SET OUT ABOVE. EXCEPT AS EXPRESSLY PROVIDED ABOVE, LG CANADA MAKES NO AND HEREBY DISCLAIMS ALL OTHER WARRANTIES AND CONDITIONS RESPECTING THE PRODUCT, WHETHER EXPRESS OR IMPLIED, INCLUDING, BUT NOT LIMITED TO, ANY IMPLIED WARRANTY OR CONDITION OF MERCHANTABILITY OR FITNESS FOR A PARTICULAR PURPOSE, AND NO REPRESENTATIONS SHALL BE BINDING ON LG CANADA. LG CANADA DOES NOT AUTHORIZE ANY PERSON TO CREATE OR ASSUME FOR IT ANY OTHER WARRANTY OBLIGATION OR LIABILITY IN CONNECTION WITH THE PRODUCT. TO THE EXTENT THAT ANY WARRANTY OR CONDITION IS IMPLIED BY LAW, IT IS LIMITED TO THE EXPRESS WARRANTY PERIOD ABOVE. LG CANADA, THE MANUFACTURER OR DISTRIBUTOR SHALL NOT BE LIABLE FOR ANY INCIDENTAL, CONSEQUENTIAL, SPECIAL, DIRECT OR INDIRECT DAMAGES, LOSS OF GOODWILL, LOST PROFITS, PUNITIVE OR EXEMPLARY DAMAGES OR ANY OTHER DAMAGE, WHETHER ARISING DIRECTLY OR INDIRECTLY FROM ANY CONTRACTUAL BREACH, FUNDAMENTAL OR OTHERWISE, OR FROM ANY ACTS OR OMISSIONS, TORT, OR OTHERWISE.

This warranty gives you specific legal rights. You may have other rights which may vary from province to province depending on applicable provincial laws. Any term of this warranty that negates or varies any implied condition or warranty under provincial law is severable where it conflicts with provincial law without affecting the remainder of this warranty's terms.

THIS LIMITED WARRANTY DOES NOT COVER:

- Service trips to deliver, pick up, or install or repair the product; instruction to the customer on operation of the product; repair or replacement of fuses or correction of wiring or plumbing, or correction of unauthorized repairs/installation.
- Failure of the product to perform during power failures and interrupted or inadequate electrical service.

WARRANTY

- Damage caused by leaky or broken water pipes, frozen water pipes, restricted drain lines, inadequate or interrupted water supply or inadequate supply of air.
- Damage resulting from operating the product in a corrosive atmosphere or contrary to the instructions outlined in the product's owner's manual.
- Damage to the product caused by accidents, pests and vermin, lightning, wind, fire, floods, or acts of God.
- Damage resulting from the misuse, abuse, improper installation, repair, or maintenance of the Product. Improper repair includes use of parts not approved or specified by LG Canada.
- Damage or product failure caused by unauthorized modification or alteration, or use for other than its intended purpose, or resulting from any water leakage due to improper installation.
- Damage or Product failure caused by incorrect electrical current, voltage, or plumbing codes, commercial or industrial use, or use of accessories, components, or cleaning products that are not approved by LG Canada.
- Damage caused by transportation and handling, including scratches, dents, chips, and/or other damage to the finish of your product, unless such damage results from defects in materials or workmanship and is reported within one (1) week of delivery.
- Damage or missing items to any display, open box, discounted, or refurbished Product.
- Products with original serial numbers that have been removed, altered, or cannot be readily determined. Model and Serial numbers, along with original retail sales receipt, are required for warranty validation.
- Increases in utility costs and additional utility expenses.
- Replacement of light bulbs, filters, or any consumable parts.
- Repairs when your Product is used in other than normal and usual household use (including, without limitation, commercial use, in offices or recreational facilities) or contrary to the instructions outlined in the Product owner's manual.
- Costs associated with removal of the Product from your home for repairs.
- The removal and reinstallation of the Product if it is installed in an inaccessible location or is not installed in accordance with published installation instructions, including the Product owner's and installation manuals.
- Shelves, door bins, drawers, handles, and accessories to the Product. Also excluded are parts besides those that were originally included with the Product.

All costs associated with the above excluded circumstances shall be borne by the consumer.

For complete warranty details and customer assistance, please call or visit our website:

Call 1-888-542-2623 (24 hours a day, 365 days a year) and select the appropriate option from the menu, or visit our website at <http://www.lg.ca>