



Scan to see the online manual.



# OWNER'S MANUAL

# WALL OVEN

---

Read this owner's manual thoroughly before operating the appliance and keep it handy for reference at all times.

**ENGLISH**

WSEP4723\*



MFL51224550  
Rev.01\_021023

[www.lg.com](http://www.lg.com)

Copyright © 2023 LG Electronics Inc. All Rights Reserved.

# TABLE OF CONTENTS

## 4 IMPORTANT SAFETY INSTRUCTIONS

---

### 4 READ ALL INSTRUCTIONS BEFORE USE

- 4 Safety Messages

### 4 WARNING

- 4 Installation
- 5 Operation
- 5 Maintenance
- 6 Risk of Fire and Flammable Materials

### 6 CAUTION

- 6 Operation
- 7 Maintenance

## 8 PRODUCT OVERVIEW

---

### 8 Product Features

- 8 Exterior / Interior
- 8 Accessories

## 10 OPERATION

---

### 10 Operating Control Panel

- 10 Control Panel Features
- 10 Energy Saving Tips

### 11 Changing Settings

- 11 Clock
- 11 Timer On/Off
- 11 Settings (Hour Mode, Convection Auto Conversion, Oven Temperature, Display Language, Preheat Alarm Light, Beeper Volume, Fahrenheit or Celsius)
- 13 Start Time (Delayed Timed Cook)
- 14 Cook Time (Timed Cook)
- 14 Sabbath Mode
- 15 Minimum & Maximum Default Settings

### 15 Operating the Oven

- 15 Before Using the Oven
- 16 Using Standard Oven Racks
- 16 Using Gliding Oven Racks
- 17 Convection Bake and Roast Mode
- 18 Bake Mode
- 19 Recommended Baking Guide
- 19 Broil Mode
- 21 Recommended Broiling Guide
- 23 Frozen Meal

- 24 Warm Mode
- 24 Proof Mode
- 24 Favorite Mode
- 25 Air Fry
- 26 Recommended Air Frying Guide
- 28 Remote Start Mode

## 29 SMART FUNCTIONS

---

### 29 LG ThinQ Application

- 29 LG ThinQ Application Features
- 29 Installing LG ThinQ Application and Connecting an LG Appliance
- 30 RF Module Specifications
- 30 FCC Notice
- 30 Open Source Software Notice Information

### 31 Smart Diagnosis™ Feature

- 31 Using LG ThinQ to Diagnose Issues
- 31 Using Audible Diagnosis to Diagnose Issues

## 32 MAINTENANCE

---

### 32 Cleaning

- 32 Interior
- 32 Exterior
- 33 EasyClean
- 35 Self Clean

### 38 Periodic Maintenance

- 38 Changing the Oven Light

## 39 TROUBLESHOOTING

---

### 39 FAQs

- 39 Frequently Asked Questions

### 41 Before Calling for Service

- 41 Cooking
- 42 Parts & Features
- 43 Noises
- 44 Wi-Fi

## 45 LIMITED WARRANTY

---

### 45 USA

- 45 TERMS AND CONDITIONS
- 45 THIS LIMITED WARRANTY DOES NOT

---

COVER

46 PROCEDURE FOR RESOLVING DISPUTES

# IMPORTANT SAFETY INSTRUCTIONS

## READ ALL INSTRUCTIONS BEFORE USE

### Safety Messages

**Your safety and the safety of others are very important.**

We have provided many important safety messages in this manual and on your appliance. Always read and follow all safety messages.



This is the safety alert symbol.

This symbol alerts you to potential hazards that can kill or injure you and others. All safety messages will follow the safety alert symbol and either the word **WARNING** or **CAUTION**.

These words mean:



### **WARNING**

You may be killed or seriously injured if you do not follow instructions.



### **CAUTION**

You may be injured or cause damage to the product if you do not follow instructions.

All safety messages will tell you what the potential hazard is, tell you how to reduce the chance of injury, and tell you what may happen if the instructions are not followed.

## WARNING

---

### **WARNING**

- To reduce the risk of explosion, fire, death, electric shock, injury or scalding to persons when using this product, follow basic precautions, including the following:
- 

### Installation

- Never allow anyone to climb, sit, stand or hang on the oven door. Injury might result from contact with hot food or the oven itself.
- Do not line the oven walls, racks, bottom, or any other part of the oven with aluminum foil or any other material. Doing so will disrupt heat distribution, produce poor baking results and cause permanent damage to the oven interior (aluminum foil will melt to the interior surface of the oven).
- Do not use aluminum foil or any other material to line the oven bottom. Improper installation of oven liners may result in a risk of electric shock or fire.
- Make sure your appliance is properly installed and grounded by a qualified installer, according to the installation instructions. Any adjustment and service should be performed only by qualified installers or service technicians.
- Be certain that all packing materials are removed from the appliance before operating. Keep plastic, clothes, paper, and other flammable materials away from parts of the appliance that may become hot.
- The electrical power must be shut off while the electrical connections are being made.
- Improper connection of aluminum house wiring to copper leads can result in an electrical hazard or fire. Use only connectors designed for joining copper to aluminum and follow the manufacturer's recommended procedure closely.

## Operation

- DO NOT TOUCH HEATING ELEMENTS OR INTERIOR SURFACES OF OVEN. Heating elements may be hot even though they are dark in color. Interior surfaces of an oven become hot enough to cause burns. During and after use, do not touch or let clothing or other flammable materials contact heating elements or interior surfaces of oven until they have had sufficient time to cool. Other surfaces, such as oven vent openings and surfaces near these openings, oven doors, and windows of oven doors, also get hot and may cause burns if not allowed to cool.
- Use care when opening door. The hot air and steam that escape can cause burns to hands, face and eyes. Let hot air or steam escape from the oven before removing or replacing food in the oven.
- Do not use plastic to cover food. Use foil or oven-safe lids only.
- Never attempt to dry a pet in the oven.
- Never use your appliance for warming or heating the room.
- Always use pot holders or oven mitts when removing food from an oven or cooktop. Cookware will be hot. Use only dry pot holders. Moist or damp pot holders on hot surfaces may result in burns from steam. Do not let the pot holder touch hot heating elements. Do not use a towel or other bulky cloth to remove food.
- Do not heat unopened food containers. Pressure in the containers may cause them to burst which may result in injury.
- Do not allow aluminum foil or the temperature probe to contact heating elements.
- Do not touch the oven racks while they are hot.
- Only arrange oven racks when the oven is cool. If a rack must be moved while the oven is hot, do not let the pot holder contact the hot heating element in the oven.
- Pull the oven rack to the stop-lock position when loading and unloading food from the oven. This helps prevent burns caused by touching hot surfaces of the door and oven walls.
- Do not use the oven if a heating element develops a glowing spot during use or shows other signs of damage. A glowing spot indicates the heating element may fail and present a potential burn, fire, or shock hazard. Turn the oven off immediately and have the heating element replaced by a qualified service technician.
- Do not leave children alone or unsupervised near the appliance when it is in use or is still hot. Children should never be allowed to sit or stand on any part of the appliance as they could be injured or burned.
- DO NOT block the oven vent during operation. This can damage the electric parts of the oven. Air must be able to move freely. The bottom vent trim should be properly assembled on the front bottom of oven before installing the oven door.
- Do not put large, heavy items such as whole turkeys on the open oven door.
- Take care when the door is open to avoid injury.
- If the door or door seals are damaged, the oven must not be operated until it has been repaired by a competent person.
- Do not allow children to crawl into the oven.
- Do not put your hand under the controller or between the door and bottom vent trim during operation. The outside of the oven can become very hot to the touch.

## Maintenance

- Do not store items of interest to children on the back guard or in cabinets above a cooking appliance. Children climbing on the oven to reach items could be seriously injured.
- Let hot cookware and utensils cool in a safe place, out of reach of small children.
- If the door glass, surface, or oven heating unit of the appliance are damaged, discontinue use of the appliance and call for service.
- Always disconnect power from the appliance before servicing.

## 6 IMPORTANT SAFETY INSTRUCTIONS

---

- Before replacing the oven light, switch off the electrical power to the oven at the main fuse or circuit breaker panel.
- Never pour cold water over a hot oven for cleaning purposes.
- Oversized food or oversized metal utensils should not be inserted in a microwave/toaster oven as they may create a fire or risk of electric shock.
- Do not clean with metal scouring pads. Pieces can burn off the pad and touch electrical parts causing a risk of electric shock.
- Do not store any materials, other than manufacturer's recommended accessories, in this oven when not in use.
- Do not cover racks or any other part of the oven with metal foil. This will cause overheating of the oven.
- If the self-cleaning mode malfunction light goes on, or if the audible signal sounds, turn off or disconnect the appliance from the power supply and have it serviced by a qualified technician.
- If the oven is heavily soiled with oil, self-clean the oven before using the oven again. The oil could cause a fire.
- If there is a fire in the oven during self-clean, turn the oven off and wait for the fire to go out. Do not force the door open. Introduction of fresh air at self-clean temperatures may lead to a burst of flame from the oven. Failure to follow this instruction may result in severe burns.
- If your oven is dropped or damaged, have it thoroughly checked by a qualified service technician before using it.

### **Risk of Fire and Flammable Materials**

- Do not store or use flammable material in or near the oven. Flammable materials include paper, plastic, pot holders, linens, wall coverings, curtains, and gasoline or other flammable vapors and liquids such as grease or cooking oil. These materials can be ignited when the oven is in use.
- Use extreme caution when moving or disposing of hot grease.
- Wear proper apparel. Do not wear loose-fitting or hanging garments, which may ignite if they contact hot surfaces, and cause severe burns.
- Do not use the oven for drying clothes. Only use the oven for its intended purpose.
- If cabinet storage is provided directly above the oven, use it to store items that are not frequently used and can be safely stored in an area subjected to heat. Temperatures may be unsafe for volatile items such as flammable liquids, cleaners or aerosol sprays.
- Do not use water on grease fires. Should an oven fire occur, leave the oven door closed and turn the oven off. If the fire continues, throw baking soda on the fire or use a fire extinguisher. Do not put water or flour on the fire. Flour may be explosive and water can spread a grease fire and cause personal injury.

## **CAUTION**

---

### **CAUTION**

- To reduce the risk of minor injury to persons, malfunction, or damage to the product or property when using this product, follow basic precautions, including the following:
- 

### **Operation**

- Always heat fat slowly, and watch as it heats.
- If frying combinations of oils and fats, stir them together before heating.
- Use a deep fat thermometer, if possible, to prevent overheating fat beyond the smoking point.
- Use the least possible amount of fat for effective shallow or deep-fat frying. Filling the pan with too much fat can cause spillovers when food is added.

- Accessible parts may become hot when the grill is in use.
- Do not place food or cookware on the bottom of the oven cavity. Doing so will cause permanent damage to the oven bottom finish.
- When using cooking or roasting bags in the oven, follow the manufacturer's directions.
- To protect against food-borne illnesses, cook meat and poultry thoroughly. The USDA has indicated the following as safe minimum internal temperatures for consumption:
  - Ground beef: 160 °F (71 °C)
  - Poultry: 165 °F (74 °C)
  - Beef, veal, pork, or lamb: 145 °F (68 °C)
  - Fish/seafood: 145 °F (68 °C)
- Do not use this oven for commercial purposes. It is made for household use only.
- The door or the outer surface may get hot when the appliance is operating.
- Do not use this oven for purposes other than cooking.
- Use caution if opening the door when the oven is operating. Hot surfaces can cause serious burns.

## Maintenance

- Do not repair or replace any part of the appliance unless specifically recommended in the manual. All other servicing should be performed by a qualified technician.
- Do not use harsh, etching, abrasive cleaners or sharp metal scrapers to clean the oven door glass since they can scratch the surface. Scratches may cause the glass to shatter.
- Make sure oven lights are cool before cleaning.
- Do not clean the door gasket. The door gasket is essential for a good seal. Care should be taken not to rub, damage, or move the gasket.
- Never keep pet birds in the kitchen. The health of birds is extremely sensitive to the fumes released during an oven self-clean cycle. Fumes may be harmful or fatal to birds. Move birds to a well-ventilated room.
- Do not rinse trays and racks by placing them in water just after cooking. This may cause breakage or damage.
- The oven should be cleaned regularly and any food deposits should be removed. Failure to maintain the oven in a clean condition could lead to deterioration of the surface that could shorten the life of the appliance and possibly result in a hazardous situation.
- Clean in the self-clean cycle only parts listed in this manual. Before self-cleaning the oven, remove the broiler pan, all oven racks and any utensils or food from the oven.

**SAVE THESE INSTRUCTIONS**

# PRODUCT OVERVIEW

## Product Features

The appearance and specifications listed in this manual may vary due to constant product improvements.

### Exterior / Interior

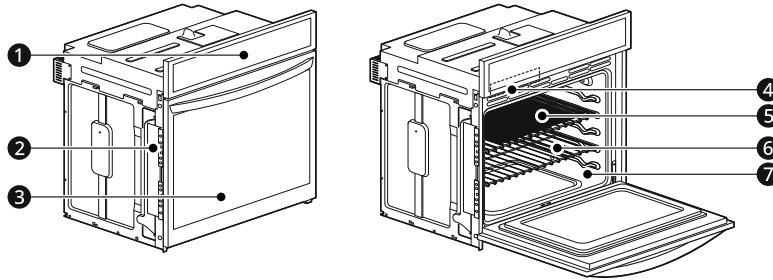

①	Oven Controller	⑤	Air Fry Tray
②	Spacer (2ea)	⑥	Standard Rack (2ea)
③	Oven Door	⑦	Gasket
④	Rating Label, Model and Serial Number Plate	-	-

### NOTE

- The model and serial number can be verified at the rating label.

## Accessories

### Accessories for Cooking

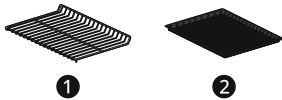

- ① Heavy Duty Standard Rack (2ea)
- ② Air Fry Tray

### Accessories for Installation

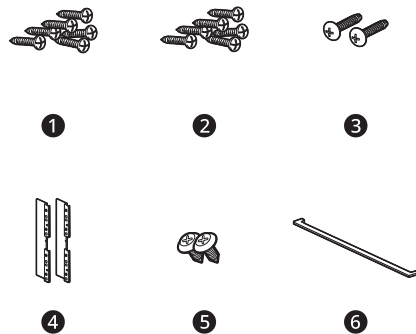

- ① 4X14 Wood screws for mounting (6 ea including 4 extras)
- ② 4X24 Wood screws for mounting (6 ea for flush installation)
- ③ 4X22 Self-tapping screws for cover bracket (2 ea)



- ④ Cover brackets for flush installation (2 ea)
- ⑤ 4X10 Screws for bottom decorative trim (2 ea)
- ⑥ Bottom Decorative Trim

### Optional Accessories (sold separately)

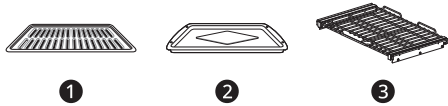

- ① Grid
- ② Broiler Pan
- ③ Gliding Rack

---

#### NOTE

- Contact LG Customer Service at 1-800-243-0000 (1-888-542-2623 in Canada) if any accessories are missing.
  - For your safety and for extended product life, only use authorized components.
  - The manufacturer is not responsible for product malfunction or accidents caused by the use of separately purchased, unauthorized components or parts.
  - The images in this guide may be different from the actual components and accessories, which are subject to change by the manufacturer without prior notice for product improvement purposes.
-

# OPERATION

## Operating Control Panel

### Control Panel Features

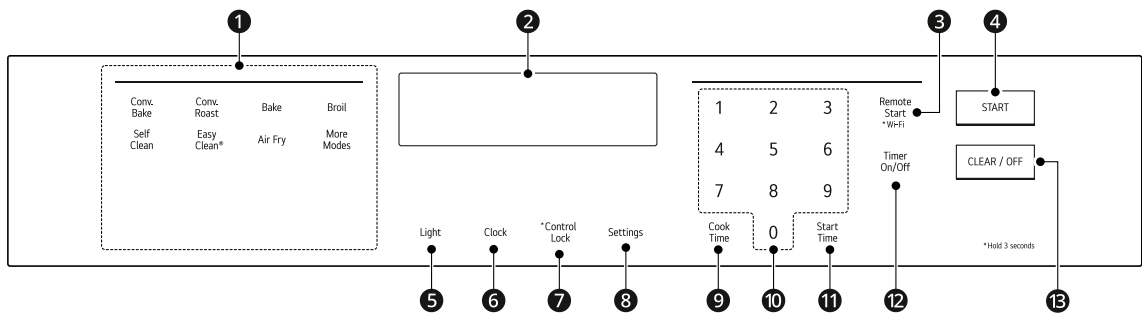

#### 1 Oven Functions

Select various functions of the oven. See **Operating the Oven**.

#### 2 Display

Oven operation and settings appear in the display

#### 3 Remote Start

- Press to select the **Remote Start** function.
- Wi-Fi**
- Press and hold the button for 3 seconds to connect the appliance to a **Wi-Fi** network.

#### 4 START

Press to start all functions in the oven.

#### 5 Light

Press to turn light on and off.

#### 6 Clock

Press to set the time of day.

#### 7 Control Lock

Press and hold the button for 3 seconds to activate/deactivate **Control Lock**.

#### 8 Settings

Press to select and adjust oven settings.

#### 9 Cook Time

Press to set the desired amount of time for food to cook. The oven shuts off when the set cooking time runs out.

#### 10 Number Pad

Use to set any function requiring numbers such as the time of day on the clock, the timer, the

oven temperature, the start time, and the length of operation for timed baking, etc.

#### 11 Start Time

Press to set the delayed timed cook. The oven starts at the set time.

#### 12 Timer On/Off

Press to set or cancel the oven timer.

#### 13 CLEAR / OFF

Press to stop cooking or cancel settings of the oven.

### NOTE

#### • Setting the Time, Timer and Temperature

If you enter one digit of a number incorrectly, enter the entire number again to correct it. For example, if you press 1, 0, 3 and 1 to set the clock for 10:30, press 1, 0, 3 and 0 to enter the correct time.

### Energy Saving Tips

- Multiple-rack cooking saves time and energy. Whenever possible, cook foods requiring the same cooking temperature together in one oven.
- For optimal performance and energy savings, follow the guides for proper rack and pan placement.
- Reduce energy use by cleaning light oven soil with the **EasyClean** feature instead of self-clean.
- Avoid opening the oven door more than necessary during use. This helps the oven maintain temperature, prevents unnecessary heat loss, and saves on energy use.

## Changing Settings

### Clock

The clock must be set to the correct time of day in order for the automatic oven timing functions to work properly.

- 1 Press **Clock**.
- 2 Press the numbers to set the time. For example, to set the clock for 10:30, press the numbers: **1**, **0**, **3** and **0**.
- 3 Press **START**.

#### NOTE

- The time of day cannot be changed during a timed baking or self-clean cycle.
- To check the time of day when the display is showing other information, press **Clock**.
- If no other buttons are pressed within 25 seconds of pressing **Clock**, the display reverts to the original setting.
- If the display time is blinking, there may have been a power failure. Reset the time.

### Timer On/Off

The Timer On/Off serves as an extra timer in the kitchen that beeps when the set time has run out. It does not start or stop cooking.

The Timer On/Off feature can be used during any of the other oven control functions.

#### For example, to set 5 minutes:

- 1 Press **Timer On/Off** once.  
0:00 appears and **Timer** flashes in the display.
- 2 Press **5**.  
0:05 appears in the display.
- 3 Press **Timer On/Off** to start the Timer. The remaining time countdown appears in the display.

#### NOTE

- If **Timer On/Off** is not pressed, the timer returns to the time of day.

- 4 When the set time runs out, **End** shows in the display. The indicator tones sound every 15 seconds until **Timer On/Off** is pressed.

#### NOTE

- If the remaining time is not in the display, recall the remaining time by pressing **Timer On/Off**.
- Press **Timer On/Off** once to set the time in hours and minutes.
- Press **Timer On/Off** twice to set the time in minutes and seconds.

### Canceling the Timer

- 1 Press **Timer On/Off** once.  
The display returns to the time of day.

### Settings (Hour Mode, Convection Auto Conversion, Oven Temperature, Display Language, Preheat Alarm Light, Beeper Volume, Fahrenheit or Celsius)

Press the **Settings** button repeatedly to toggle through and change oven settings.

The **Settings** button allows you to:

- set the hour mode on the clock (12 or 24 hours)
- enable/disable convection auto conversion
- adjust the oven temperature
- select display language
- activate/deactivate the preheating alarm light
- set the beeper volume
- switch the temperature scale between Fahrenheit and Celsius

### Setting the Hour Mode

The control is set to use a 24-hour clock. To reset the clock to 12-hour mode, follow the steps below.

- 1 Press **Settings** once.

## 12 OPERATION

---

- Press **1** to select a 12-hour clock, or **2** to select a 24-hour clock.
- Press **START** to accept the change.

### Setting Convection Auto Conversion

When **Conv. Bake** and **Conv. Roast** are selected, Convection Auto Conversion automatically converts the standard recipe temperature entered to a convection temperature by subtracting 25 °F / 14 °C. This auto converted temperature shows on the display. For example, select **Conv. Bake**, enter 350 °F, and 325 °F shows on the display after preheat.

Convection Auto Conversion is enabled by default. To change the setting, follow these instructions.

- Press **Settings** repeatedly until **Auto** appears in the display.
- Press **1** to enable or **2** to disable auto conversion.
- Press **START** to accept the change.

### Adjusting the Oven Temperature

Your new oven may cook differently from the one it replaced. Use your new oven for a few weeks to become more familiar with it before changing the temperature settings. If after familiarizing yourself with the new oven, you still think that it is too hot or too cold, you can adjust the oven thermostat yourself.

- To begin, either raise or lower the thermostat 15 °F (8 °C). Try the oven with the new setting. If the oven still needs adjustment, raise or lower the thermostat again, using the first adjustment as a gauge. For example, if the adjustment was too much, raise or lower the thermostat 10 °F (5 °C). If the adjustment was not enough, raise or lower the thermostat 20 °F (12 °C). Proceed in this way until the oven is adjusted to your satisfaction.

- Press **Settings** repeatedly until **ADJ** appears in the display.
- Use the number buttons to enter the number of degrees you want to adjust the oven temperature.

- Adjust the temperature either up or down by pressing **Settings** repeatedly to toggle between plus (+) or minus (-).
- Press **START** to accept the change.

---

### NOTE

- This adjustment does not affect the broiling or Self Clean temperatures. The adjustment is retained in memory after a power failure. The oven temperature can be increased (+) or decreased (-) as much as 35 °F or 19 °C.
- Once the temperature is increased or decreased, the display shows the adjusted temperature until it is changed.
- The thermostat adjustment for Bake will also affect Convection Bake, Convection Roast, Roast or Crisp Convection.

---

### Selecting the Display Language

The oven control is set to display in English but can be changed to display in Spanish or French.

- Press **Settings** repeatedly until **Ln3** appears in the display.
- Press **1** for English, **2** for Spanish, or **3** for French.
- Press **START** to accept the change.

### Turning the Preheat Alarm Light On/Off

When the oven reaches its set-temperature, the preheating alarm light flashes 5 times or until the oven door is opened.

You can activate or deactivate the preheating alarm light.

- Press **Settings** repeatedly until **PrE** appears in the display.
- Press **1** to turn the light on and **2** to turn the light off.
- Press **START** to accept the change.

## Adjusting the Beeper Volume

- 1 Press **Settings** repeatedly until BEEP appears in the display.
- 2 Press **1** for Loud, **2** for Low, and **3** for Mute.
- 3 Press **START** to accept the change.

## Selecting Fahrenheit or Celsius

Set the oven temperature display to show either Fahrenheit (°F) or Celsius (°C) units. The oven defaults to Fahrenheit unless changed by the user.

- 1 Press **Settings** repeatedly until Unit appears in the display.
- 2 Press **1** for °F (Fahrenheit) or **2** for °C (Celsius).
- 3 Press **START** to accept the change.

## Start Time (Delayed Timed Cook)

The automatic timer of this function turns the oven on and off at the time you select.

This function can only be used with the below oven functions.

Model	Oven Functions
WSE P472 7*	<b>Bake, Conv. Bake, Conv. Roast, Steam Bake, Steam Roast</b>
WSE P472 3*	<b>Bake, Conv. Bake, Conv. Roast</b>

### CAUTION

- Use caution with the Delayed Timed Cook features. Use the automatic timer when cooking cured or frozen meats and most fruits and vegetables. Foods that can easily spoil, such as milk, eggs, fish, meat or poultry, should be chilled in the refrigerator first. Even when chilled, they should not stand in the oven for more than 1 hour before cooking begins, and should be removed promptly when cooking is

complete. Eating spoiled food can result in sickness from food poisoning.

## Setting a Delayed Timed Cook

For example, to bake at 300 °F and delay the start of baking until 4:30, first set the clock for the correct time of day.

- 1 Arrange interior oven rack(s) and place the food in the oven.
- 2 Press **Bake**. 350 °F appears in the display.
- 3 Set the temperature: press **3**, **0** and **0**.
- 4 Press **Cook Time** and press the number buttons to set the baking time.
  - The baking time can be set for any amount of time between 1 minute and 11 hours and 59 minutes.
- 5 Press **Start Time**.
- 6 Set the start time: press **1**, **6**, **3** and **0** for 4:30.
- 7 Press **START**. A short beep sounds and the start time appears in the display. The oven begins baking at the set start time.

### NOTE

- cancel this function, press **CLEAR/OFF** at any time.
- To change the cooking time, repeat step 4 and press **START**.
- If the oven clock is set as a 12-hour clock, you can delay the cook time for 12 hours. If the oven clock is set as a 24-hour clock, you can delay the cook time for 24 hours.
- During the preheating mode, the convection fan operates constantly to circulate the hot air. The convection fan turns off automatically after the preset temperature is attained.
- After any cooking cycle has been completed cooling fans operate to protect the control panel. This is normal.

## 14 OPERATION

The oven will continue to cook for the set amount of time and then turn off automatically. When the cooking time has elapsed:

- The time of day shows in the display.
- The cook end indicator tone sounds every 60 seconds until **CLEAR/OFF** is pressed.

### Cook Time (Timed Cook)

Set the oven to cook for a specific length of time using this function.

This function can only be used with the below oven functions.

Mode I	Oven Functions
WSEP4 727*	<b>Bake, Conv. Bake, Conv. Roast, Broil, Steam Bake, Steam Roast, Steam Sous-Vide, Air Fry, Frozen Meal, Favorite Mode</b>
WSEP4 723*	<b>Bake, Conv. Bake, Conv. Roast, Broil, Air Fry, Frozen Meal, Favorite Mode</b>

### Setting a Timed Cook

For example, to bake at 300 °F for 30 minutes, first set the clock to the correct time of day.

- 1 Press **Bake**. 350 °F appears in the display.
- 2 Set the temperature. Press **3, 0** and **0**.
- 3 Press **Cook Time**. **Timed** flashes in the display. **Bake**, 0:00 and 300 °F appear in the display.
- 4 Set the baking time: press **3** and **0** (for 30 minutes).
  - The baking time can be set for any amount of time between 1 minute and 11 hours and 59 minutes.
- 5 Press **START**.
- 6 Press **CLEAR/OFF** to cancel this function at any time.

The oven will continue to cook for the set amount of time and then turn off automatically. When the cooking time has elapsed:

- The time of day shows in the display.
- The cook end indicator tone sounds every 60 seconds until **CLEAR/OFF** is pressed.

### Changing the Cook Time during Cooking

For example, to change the cook time to 1 hour and 30 minutes during cooking:

- 1 Press **Cook Time**.
- 2 Change the baking time: press **1, 3, 0**.
- 3 Press **START** to accept the change or press **CLEAR/OFF** to reset the time.

### NOTE

- During the preheating mode, the convection fan operates constantly to circulate the hot air. The convection fan turns off automatically after the preset temperature is attained.
- After any cooking cycle has been completed cooling fans operate to protect the control panel. This is normal.

### Sabbath Mode

Sabbath mode is typically used on the Jewish Sabbath and Holidays. While the oven is in Sabbath mode, the temperature cannot be changed and the timer, light, and alarm functions are disabled. When the Sabbath mode is activated, the oven does not turn off until the Sabbath mode is deactivated. In Sabbath mode, all function buttons are inactive. 5b will appear in the display.

- 1 Press **Bake**.
- 2 Press the numbers to enter the desired temperature.
- 3 Press **START**.
- 4 Press and hold **Settings** for 3 seconds. 5b appears in the display when the Sabbath mode is activated.



- 5** To stop the Sabbath mode, press and hold **Settings** for 3 seconds.

#### NOTE

- If a cook time is set, the oven turns off automatically at the end of the cook time, without chiming. The oven remains in Sabbath mode, but is turned off.

- If no cook time is set, the oven will not automatically turn off.
- After a power failure, the display will turn back on in Sabbath mode, but the oven will be off.
- Always close the oven door before engaging Sabbath Mode.

## Minimum & Maximum Default Settings

All of the features listed have a minimum and a maximum time or temperature setting that may be entered into the control. An entry acceptance beep sounds each time a control button is pressed.

An entry error tone (two short tones) sounds if the entry of the temperature or time is below the minimum or above the maximum setting for the feature.

Feature	Min. Time	Max. Time	Default
Warm	-	-	3 hr.
Self Clean	3 hr.	5 hr.	4 hr.

Feature	Min. Temp.	Max. Temp.	Default
Conv. Bake / Conv. Roast	170 °F / 80 °C	550 °F / 285 °C	350 °F (325 °F) <sup>†</sup> / 12 hr.
Bake / Roast	170 °F / 80 °C	550 °F / 285 °C	350 °F / 12 hr.
Broil	Lo 350 °F	Hi 550 °F	Hi 550 °F
Proof	-	-	100 °F
Warm	Lo 140 °F	HI 200 °F	Medium: 170 °F

<sup>†</sup> Using auto conversion

#### NOTE

- Default cook mode times are without setting a cook time.

## Operating the Oven

### Before Using the Oven

#### NOTE

- Because the oven temperature cycles, an oven thermometer placed in the oven cavity may not show the same temperature that is set on the oven.

- It is normal for the convection fan to run while preheating during a regular bake cycle.
- The convection fan motor may run periodically during a regular bake cycle.
- The heat turns off if the door is left open during baking. If the door is left open for longer than 30 seconds during baking, the heat turns off. The heat turns back on automatically once the door is closed.

**NOTE**

- Avoid opening the oven door more than necessary during use. This helps the oven maintain temperature, prevents unnecessary heat loss, and saves on energy use.

**Oven Vent**

Areas near the vent may become hot during operation and may cause burns. Avoid placing plastics near the vent as heat may distort or melt the plastic.

It is normal for steam to be visible when cooking foods with high moisture content.

**⚠ WARNING**

- Do not block the vent opening at the bottom of the oven.

**Using Standard Oven Racks**

The racks have a turned-up back edge that prevents them from being pulled out of the oven cavity.

**⚠ CAUTION**

- Replace oven racks before turning the oven on to prevent burns.
- Do not cover the racks with aluminum foil, or any other material, or place anything on the bottom of the oven. Doing so will result in poor baking and may damage the oven bottom.
- Do not place objects heavier than 33 lb (15 kg) on the racks. Do not place heavy objects on the corners of the racks. Doing so can damage the racks.

**Removing Racks**

- 1 Pull the rack straight out until it stops.
- 2 Lift up the front of the rack and pull it out.

**Replacing Racks**

- 1 Place the end of the rack on the support.
- 2 Tilt the front end up and push the rack in.

**Using Gliding Oven Racks**

The optional gliding racks slide in and out on a frame. This keeps heavy cookware level and prevents it from sliding forward when the rack is completely extended.

**⚠ CAUTION**

- Place oven racks in the desired location before turning on the oven to avoid burns.
- Do not cover the racks with aluminum foil, or any other material, or place anything on the bottom of the oven. Doing so will result in poor baking and may damage the oven bottom.

**Installing Gliding Racks**

- 1 Start with the rack in the closed position. Hold the rack with one hand at the center front and the other hand at the back right corner.
- 2 Carefully insert the rack between the rack guides, and slide it back until the shelf drops into place.

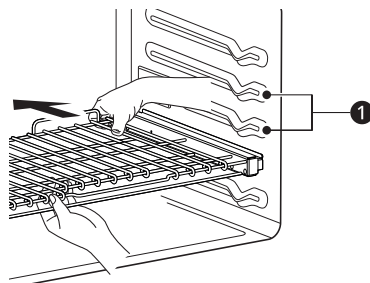

① Rack Guides

- 3 Once the rack is secured in the back, pull the entire rack forward until the rack locks into place.

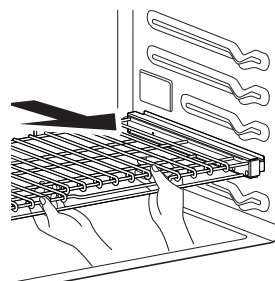



## Removing Gliding Racks

- 1 With the rack in the closed position, grasp the front of the rack and frame and lift up. Slowly push the rack towards the back wall until it is free of the rack stop.
- 2 After disengaging the rack stop, lift the back of the rack and pull the rack and frame out between the rack guides.

## Convection Bake and Roast Mode

The convection system uses a fan to circulate the heat evenly within the oven. Improved heat distribution allows for even cooking and excellent results while cooking with single or multiple racks.

The oven can be programmed to bake at any temperature from 170 °F (80 °C) to 550 °F (285 °C). The default temperature is 350 °F (175 °C).

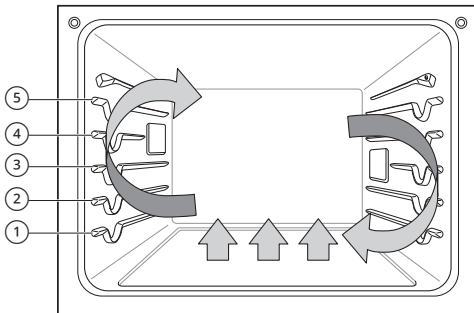

## Using Convection

- 1 Press **Conv.Bake** or **Conv.Roast**.
- 2 Press the numbers to enter the desired temperature.
- 3 If desired, press **Cook Time** to set the cook time or **Start Time** to set the delayed start time. Press the numbers to set the time settings.
- 4 Press **START**. The oven starts to preheat.
- 5 If the cook time is set, the remaining time appears in the display. If a delayed start time is set, the start time appears in the display.

- 6 A chime sounds once preheating is complete.
- 7 A chime sounds at the end of the set cook time and a notification appears in the display. Open the oven door and remove the food.

### NOTE

- If no cook time is set, the oven turns off automatically after 12 hours.
- The heating elements and fan turn off immediately when the door is opened. They turn on again approximately 1 second after the door is closed.
- Press **Stop** in the display to cancel Convection Bake and Convection Roast at any time.
- The oven fan runs while convection baking and convection roasting. The fan stops when the door is opened. In some cases, the fan may shut off during a convection bake cycle.

## Changing the Cook Settings

- 1 Press **Conv.Bake** or **Conv.Roast**.
- 2 Press the numbers to enter the desired temperature.
- 3 Press **START**.

## To Stop Cooking

- 1 Press **CLEAR / OFF**.

## Tips for Convection Baking

- Use Convection Bake for faster and more even multiple-rack cooking of pastries, cookies, muffins, biscuits, and breads of all kinds.
- Bake cookies and biscuits on pans with no sides or very low sides to allow heated air to circulate around the food. Food baked on pans with a dark finish will cook faster.
- When using Convection Bake with a single rack, place oven rack in position ③. If cooking on multiple racks, place the oven racks in positions ② and ④.
- Multiple oven rack cooking may slightly increase cook times for some foods.
- Cakes, cookies and muffins have better results when using multiple racks.

## 18 OPERATION

---

The Convection Roast feature is designed to give optimum roasting performance. Convection Roast combines cooking with the convection fan to roast meats and poultry. The heated air circulates around the food from all sides, sealing in juices and flavors. Foods are crispy brown on the outside while staying moist on the inside. Convection roasting is especially good for large tender cuts of meat, uncovered.

### Tips for Convection Roasting

Use a \*broiler pan and \*grid when preparing meats for convection roasting. The broiler pan catches grease spills and the grid helps prevent grease splatters.

1 Place the oven rack in position ① or ②.

2 Place the grid ① in the broiler pan ②.

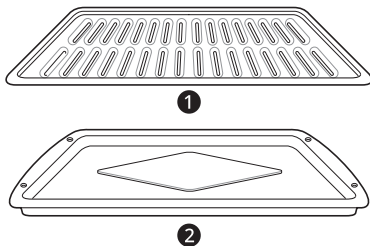

3 Place the broiler pan on the oven rack.

---

#### NOTE

- \* : Sold separately
- 

---

#### ⚠ CAUTION

- Do not use a broiler pan without a grid.
  - Do not cover the grid with aluminum foil.
  - Position food (fat side up) on the grid.
- 

### Bake Mode

Bake is used to prepare foods such as pastries, breads and casseroles.

The oven can be programmed to bake at any temperature from 170 °F (80 °C) to 550 °F (285 °C). The default temperature is 350 °F (175 °C).

### Setting the Bake Function

1 Press **Bake**.

2 Press the numbers to enter the desired temperature.

3 If desired, press **Cook Time** to set the cook time or **Start Time** to set the delayed start time. Press the numbers to set the time settings.

4 Press **START**. The oven starts to preheat.

5 If the cook time is set, the remaining time appears in the display. If a delayed start time is set, the start time appears in the display.

6 A chime sounds once preheating is complete.

7 A chime sounds at the end of the set cook time and a notification appears in the display. Open the oven door and remove the food.

---

#### NOTE

- If no cook time is set, the oven turns off automatically after 12 hours.
- 

### Changing the Cook Settings

1 Press **Bake**.

2 Press the numbers to enter the desired temperature.

3 Press **START**.

### To Stop Cooking

Press **CLEAR / OFF**.

---

#### NOTE

- It is normal for the convection fan to operate periodically throughout a normal bake cycle in the oven. This is to ensure even baking results.
- 

### Baking Tips

- For best results, food should be placed on a single rack with at least 1" to 1 1/2" of air space between the pans and oven walls.

- Baking time and temperature will vary depending on the characteristics, size, and shape of the baking pan used.
- Check for food doneness at the minimum recipe time.
- Use metal bakeware (with or without a nonstick finish), heatproof glass-ceramic, ceramic or other bakeware recommended for oven use.
- Dark metal pans or nonstick coatings will cook food faster with more browning. Insulated bakeware will slightly lengthen the cooking time for most foods.
- The oven bottom has a porcelain-enamel finish. To make cleaning easier, protect the oven bottom from excessive spillovers by placing a cookie sheet on the rack below the rack you are cooking on. This is particularly important when baking a fruit pie or other foods with a high acid content. Hot fruit fillings or other foods that are highly acidic may cause pitting and damage to the porcelain-enamel surface and should be wiped up immediately.

## Recommended Baking Guide

### Rack and Pan Placement

Baking results will be better if baking pans are centered in the oven as much as possible. If cooking on multiple racks, place the oven racks in the positions shown.

Multiple-rack cooking saves time and energy. Whenever possible, cook foods requiring the same cooking temperature together in one oven.

If baking with more than one pan, place the pans so that each one has at least 1" to 1 1/2" of air space around them.

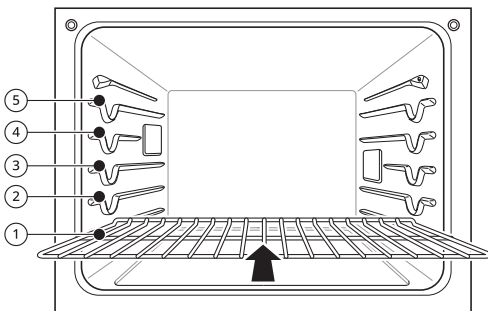

### Multiple Rack

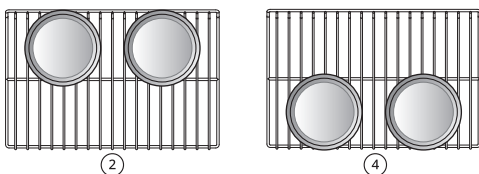

Standard Rack (Position ②)

Standard Rack (Position ④)

### Single Rack

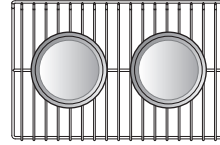

### Baking Rack Guide

Type of Food	Rack Position
Angel food cake, frozen pies	③
Bundt or pound cakes	②
Biscuits, muffins, brownies, cookies, cupcakes, layer cakes, pies	③
Casseroles	②
Turkey, roasts, or ham	①
Frozen pizza	③
Roast chicken	②

### NOTE

- When baking cakes and cookies on multiple racks, use the Convection Bake mode and place racks in positions ② and ④.

## Broil Mode

### Setting the Oven to Broil

Broiling uses an intense, radiant heat to cook food. Both the inner and outer broil elements heat during full broiling. Only the inner broil element heats during center broiling. The element(s) cycle on and off at intervals to maintain the oven temperature. The meat probe cannot be used with this mode.

Keep the oven door closed while broiling. Let the oven preheat for approximately 5 minutes before cooking food.

### CAUTION

- Do not use a broiler pan without a grid. Oil can cause a grease fire.
- Do not cover the grid and broiler pan with aluminum foil. Doing so will cause a fire.

**⚠ CAUTION**

- Always use a broiler pan and grid for excess fat and grease drainage. This will help to reduce splatter, smoke, and flare-ups.
- Should an oven fire occur, leave the oven door closed and turn the oven off. If the fire continues, throw baking soda on the fire or use a fire extinguisher.
- DO NOT put water or flour on the fire. Flour may be explosive and water can cause a grease fire to spread and cause personal injury.
- When using your broiler, the temperature inside the oven will be extremely high. Take care to avoid possible burns by:
  - Keeping the door closed when broiling
  - Always wearing oven mitts when inserting or removing food items

**NOTE**

- This appliance is designed for closed-door broiling. Close the door to set the Broil function. If the door is open, the Broil function cannot be set and **DOOR OPEN** appears on the display. Close the door and reset the Broil function. If the door is opened during broiling, the broil burner turns off after five seconds. The broiler turns back on automatically once the door is closed.

- 1 Place the food on the grid in the broiler pan.
- 2 Press **Broil**.
- 3 Press **1** for Full broil, **2** for Center broil.
- 4 Press **1** for High, **2** for Medium, or **3** for Low temperature setting.
- 5 If desired, press **Cook Time** to set the cook time. Press the numbers to set the time settings.
- 6 Press **START**.
- 7 Let the oven preheat for approximately 5 minutes before cooking the food.

- 8 If the cook time is set, the remaining time appears in the display.
- 9 Press **CLEAR / OFF** to cancel at any time or when cooking is complete.

**NOTE**

- If the cook time is not set, the oven automatically turns off after 3 hours.
- The heating element(s) turn off immediately when the door is opened. They turn on again approximately 1 second after the door is closed.

**Changing the Broil Settings**

- 1 Press **Broil**.
- 2 Press the numbers to enter the desired temperature.
- 3 Press **START**.

**To Stop Broiling**

Press **CLEAR / OFF**.

**Tips for Reducing Smoke**

Due to the intense heat associated with broiling, it is normal to experience smoke during the cooking process. This smoke is a natural byproduct of searing and should not cause you to worry. If you are experiencing more smoke than you are comfortable with, use the following tips to reduce the amount of smoke in your oven.

- Always use a broiler pan. Do not use saute pans or regular baking sheets for safety reasons.
- The broiler pan should always be thoroughly cleaned and at room temperature at the beginning of cooking.
- ALWAYS run your cooktop ventilation system or vent hood during broiling.
- Keep the interior of your oven as clean as possible. Leftover debris from prior meals can burn or catch fire.
- Avoid fatty marinades and sugary glazes. Both of these will increase the amount of smoke you experience. If you would like to use a glaze, apply it at the very end of cooking.

- If you are experiencing significant smoke with any food item, consider:
  - Lowering the broiler to the **LO** setting.
  - Lowering the rack position to cook the food farther away from the broiler.
  - Using the **HI** broil setting to achieve the level of searing you desire, and then either

switching to the **LO** broil setting, or switching to the Bake function.

- As a rule, fattier cuts of meat and fish will produce more smoke than leaner items.
- Adhere to the guidelines in the **Recommended Broiling Guide** section whenever possible.

## Recommended Broiling Guide

### Recommended Broiling Guide

The size, weight, thickness, starting temperature, and your preference of doneness will affect broiling times.

This guide is based on meats at refrigerator temperature. For best results when broiling, use a pan designed for broiling.

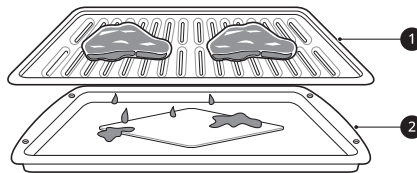

① Grid (sold separately)

② Broiler Pan (sold separately)

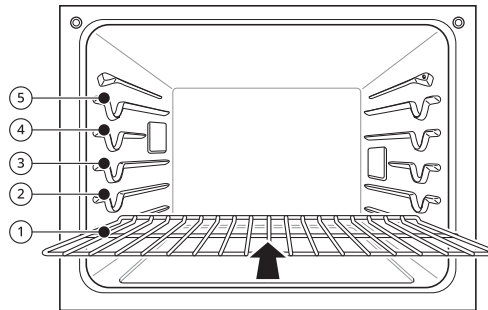

Food	Quantity and/or Thickness	Rack Position	First Side Time (min.)	Second Side Time (min.)	Comments
<b>Ground Beef</b>	1 lb (9 patties) 1/2 to 3/4" thick	⑤	4-6	3-4	Space evenly. Up to 9 patties may be broiled at once.

Food	Quantity and/or Thickness		Rack Position	First Side Time (min.)	Second Side Time (min.)	Comments
<b>Beef Steaks</b>	1" thick 1 to 1½ lbs.	Rare	④	6	2-3	Steaks less than 1" thick cook through before browning. Pan frying is recommended. Slash fat.
		Medium	④	7	2-3	
		Well done	④	8	3-4	
	1½" thick 2 to 2½ lbs	Rare	④	10	4-6	
		Medium	④	12	6-8	
		Well done	④	14	8-10	
<b>Chicken</b>	1 whole, 2 to 2½ lbs., split lengthwise		③	20	6-8	Broil skin-side-down first.
	2 Breasts		③	20	6-10	
<b>Lobster Tails</b>	2-4 10 to 12 oz each		③	12-14	Do not turn over.	Cut through back of shell. Spread open. Brush with melted butter before broiling and after half of broiling time.
<b>Fish Fillets</b>	¼ to ½" thick		④ or ⑤	5-6	3-4	Handle and turn very carefully. Brush with lemon butter before and during cooking, if desired.
<b>Ham Slices (precooked)</b>	½" thick		④	5	3-5	Increase time 5 to 10 minutes per side for 1½" thick or home-cured ham.
<b>Pork Chops</b> Well done	2 (½" thick)		④ or ⑤	7	6-8	Slash fat.
	2 (1" thick) about 1lb.		④ or ⑤	9-10	7-9	
<b>Lamb Chops</b>	2 (1" thick) about 10 to 12 oz	Medium	④	6	4-6	Slash fat.
		Well done	④	8	7-9	
	2 (1½" thick) about 1lb	Medium	④	11	9	
		Well done	④	13	9-11	
<b>Salmon Steaks</b>	2 (1" thick)		④ or ⑤	8	3-4	Grease pan. Brush steaks with melted butter.
	4 (1" thick) about 1 lb		④ or ⑤	9	4-6	

- This guide is only for reference. Adjust cook time according to your preference.

## NOTE

- The USDA advises that consuming raw or undercooked fish, meat, or poultry can increase your risk of food-borne illness.

- The USDA has indicated the following as safe minimum internal temperatures for consumption:
  - Ground beef: 160 °F (71.1 °C)
  - Poultry: 165 °F (73.9 °C)
  - Beef, veal, pork, or lamb: 145 °F (62.8 °C)
  - Fish / Seafood: 145 °F (62.8 °C)

## Tips for Broiling

### Beef

- Steaks and chops should always be allowed to rest for five minutes before being cut into and eaten. This allows the heat to distribute evenly through the food and creates a more tender and juicy result.
- Pieces of meat that are thicker than two inches should be removed from the refrigerator 30 minutes prior to cooking. This will help them cook more quickly and evenly, and will produce less smoke when broiling. Cooking times will likely be shorter than the times indicated in the Broiling Chart.
- For bone-in steaks or chops that have been frenched (all meat removed from around the bone), wrap the exposed sections of bone in foil to reduce burning.

### Seafood

- When broiling skin-on fish, always use the Lo broil setting and always broil the skin side last.
- Seafood is best consumed immediately after cooking. Allowing seafood to rest after cooking can cause the food to dry out.
- It is a good idea to rub a thin coating of oil on the surface of the broiling pan before cooking to reduce sticking, especially with fish and seafood. You can also use a light coating of non-stick pan spray.

### Vegetables

Toss your vegetables lightly in oil before cooking to improve browning.

## Frozen Meal

The Frozen Meal function is specially designed for cooking frozen prepared meals. It heats from both the top and bottom to brown food more evenly.

This system is designed to give the optimum cooking performance by automatically selecting a combination of the broil and bake heating systems. No preheating is required when using the Frozen Meal mode. For best results with frozen pizza, cook food on a single rack placed in position 4 at 400 °F.

### Setting the Frozen Meal Function

- 1 Press **More Modes**.
- 2 Press **1**.
- 3 Press **START** or the numbers to enter the desired temperature from 300 °F to 550 °F.

- 4 If desired, press **Cook Time** to set the cook time. Press the numbers to set the time settings.

- 5 Press **START**

### Changing the Frozen Meal Settings

- 1 Press **More Modes**.
- 2 Press the numbers to enter the desired temperature.

- 3 Press **START**

### Canceling the Frozen Meal Function

Press **CLEAR / OFF**.

### Warm Mode

This function will maintain an oven temperature of less than 200 °F (93.3 °C). It will keep cooked food warm for serving up to 3 hours after cooking has finished.

#### Setting the Warm Mode

- 1 Press **More Modes**.
- 2 Press **2**.
- 3 Press **1** for High, **2** for Medium, or **3** for Low temperature setting.
  - High: 200 °F (93.3 °C)
  - Medium: 170 °F (76.7 °C)
  - Low: 140 °F (60 °C)
- 4 Press **START**. If the run time was set, the remaining time appears in the display.

#### Canceling the Warm Function

Press **CLEAR / OFF**.

---

#### NOTE

- The Warm function is intended to keep food warm. Do not use it to cool food down.
- 

### Proof Mode

This feature maintains a warm oven for rising yeast-leavened products before baking.

#### Setting the Proof Mode

- 1 Press **More Modes**.
- 2 Press **3**.
- 3 Press the numbers to set the time settings.
- 4 Press **START**. The remaining proofing time appears in the display.

---

#### NOTE

- If the proofing time is not set, the oven automatically turns off after 12 hours.
- 

#### Canceling the Proof Function

Press **CLEAR / OFF**.

---

#### NOTE

- To avoid lowering the oven temperature and lengthening proofing time, do not open the oven door unnecessarily. Check bread products early to avoid over proofing.
  - Do not use the Proofing mode for warming food or keeping food hot. The proofing oven temperature is not hot enough to keep foods at safe temperatures. Use the Warm feature to keep food warm. Proofing does not operate when the oven is above 125 °F. **OVEN IS HOT** shows in the display.
  - It is normal for the fan to operate during the Proof function.
  - The proof feature automatically provides the optimum temperature for the proofing process, and therefore does not have a temperature adjustment.
  - For best results, cover the dough with a cloth or with plastic wrap. (The plastic may need to be anchored underneath the container so the oven fan does not blow it off.)
- 

### Favorite Mode

For frequently used cooking menus, you can combine up to three different temperatures and cooking modes into one hot key.

#### Creating a Favorite

- When combining two or more cooking modes, a cooking time or probe temperature must be set before selecting an additional cooking mode.
- The Probe function cannot be used with the Broil, Warm, or Proof modes.

- 1 Press **More Modes**.

- 2 Press **4**.



- 3** Press **More Modes** repeatedly to select the desired recipe.

Recipe	Default Temp. (°F) (may be changed and recalled)	Cooking Mode
1. Bread	375	<b>Bake</b>
2. Meat	325	<b>Conv.Roast</b>
3. Chicken	350	<b>Conv.Roast</b>

- 4** Press the numbers to enter the desired temperature.
- Only the selected temperature is stored, not the cooking time.
  - If the oven temperature is changed, the changed temperature is stored.
- 5** If desired, press **Cook Time** to set the cook time. Press the numbers to set the time settings.
- 6** Press **START**. Once the oven reaches the desired temperature, **PREHEATING** appears in the display.

#### NOTE

- Proofing doesn't operate when the oven is above 125 °F (52 °C).
- If using Proof after cooking, wait for the oven to cool first.
- The Proof mode can only be set as a single stage, not as part of multi-stage cooking.

## Air Fry

This feature automatically increases the entered temperature by 45 °F for optimal performance when using Air Fry.

The Air Fry mode on the upper oven can be programmed to cook at any temperature from 300 °F (150 °C) to 500 °F (260 °C). The default temperature is 400 °F (205 °C).

The Air Fry function is specially designed for oil-free frying.

## Setting the Air Fry Mode

- 1** Press **Air Fry**.
- 2** Press the numbers to enter the desired temperature.
- 3** If desired, press **Cook Time** to set the cook time. Press the numbers to set the time settings.
- 4** Press **START**.
- 5** If the cook time is set, the remaining time appears in the display.

## Changing the Cook Settings

- 1** Press **Air Fry**.
- 2** Press the numbers to enter the desired temperature.
- 3** Press **START**.

## To Stop Cooking

Press **CLEAR / OFF**.

#### NOTE

- No preheating is required when using the Air Fry mode.
- If cooking multiple batches, the later batches may take less time to cook.
- Wet batters and coatings will not crisp or set when using the Air Fry mode.

## Tips for Air Fry

- For best results, use the provided air fry tray.
  - The mesh section of the air fry tray can be cleaned in a dishwasher.

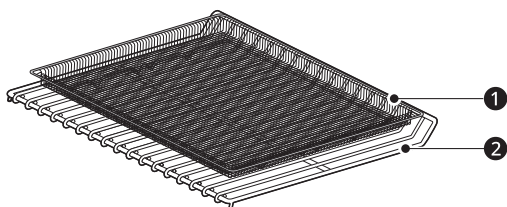

① Air Fry Tray

② Heavy Duty Rack

- If you don't have the air fry tray, place food on a wire rack inside a foil-lined broiler pan.

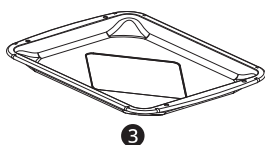

③ Broiler Pan

- For best results, cook food on a single rack placed in positions suggested in the chart in this manual.
- Spread the food out evenly in a single layer.
- Use either the air fry tray or a dark baking tray with no sides or short sides that does not cover the entire rack. This allows for better air circulation.
- If desired, spray the baking tray or air fry tray with a pan spray. Use an oil that can be heated to a high temperature before smoking, such as avocado, grapeseed, peanut or sunflower oil.
- Place a foil-lined baking tray on a rack in position 1 to catch the oil falling from the food. For high-fat foods like chicken wings, add a few sheets of parchment paper to absorb the fat.
- Check food often and shake it or turn it over for crisper results.
- Prepared frozen foods may cook faster with the Air Fry mode than stated on the package. Reduce the cooking time by about 20 percent, check food early, and adjust cooking time as needed.

## Recommended Air Frying Guide

- Arrange food evenly in a single layer.
- Put a foil-lined baking pan on a rack in position ② to catch drips. If needed, add parchment paper to absorb oil and reduce smoking.

- Use a food thermometer to make sure food has reached a safe temperature for consumption. Eating undercooked meats can increase your risk of food-borne illness.
- For the crispiest results, dredge fresh chicken wings or tenders in seasoned flour. Use 1/3 cup flour for 2 pounds of chicken.

## Recommendations When Air Frying High-Fat Foods

Foods high in fat will smoke when using the Air Fry mode. For best results, follow these recommendations when air frying foods that are high in fat, such as chicken wings, bacon, sausage, hot dogs, turkey legs, lamb chops, ribs, pork loin, duck breasts, or some plant-based proteins.

### ⚠ CAUTION

- Never cover slots, holes, or passages in the oven bottom or cover entire racks with materials such as aluminum foil. Doing so blocks airflow through the oven and can result in carbon monoxide poisoning. Aluminum foil can also trap heat, causing a fire hazard or poor oven performance.
- Turn on your exhaust hood at a high fan setting before you start Air Fry and leave it on for 15 minutes after you're done.
- Open a window or sliding glass door, if possible, to make sure the kitchen is well-ventilated.
- Clean the grease filters on your exhaust hood regularly.
- Keep the oven free from grease buildup. Wipe down the interior of the oven before and after air frying (once the oven has cooled).
- Run oven cleaning cycles (Easy Clean or SelfClean) regularly, depending on how often and what types of food you Air Fry.
- Avoid opening the oven door more than necessary to help maintain the oven temperature, prevent heat loss, and save energy.
- Air-frying fresh chicken pieces such as wings or drumsticks with the skin left on can produce smoke as the fat renders at high temperatures. If the smoke is excessive, use the Convection Roast mode instead of Air Fry.

- Flip food over during cooking to avoid burning it.

† High-fat items may produce more smoke when cooked using Air Fry. For less smoke, cook using Convection Roast mode.

Recommended Items	Quantity (oz)	Temp. (°F)	Rack Position	Time	Guide
<b>POTATOES-Frozen</b>					
Frozen French Fries (Shoestring)	20	425	③	15-25	-
Frozen French Fries (Crinkle cut, 10x10 mm)	35	400	③	18-28	-
Frozen Sweet Potato Fries	25	400	③	15-25	-
Frozen Tater Tots	50	425	③	18-28	-
Frozen Hash Browns	40	425	③	18-28	-
<b>POTATOES-Fresh/Homemade</b>					
Homemade French Fries (10x10 mm)	25	425	③	20-30	Cut the potatoes and soak for 30 minutes in hot tap water. Drain and pat dry. Brush or lightly spray with 3 tbsp. of oil. Add salt and pepper to taste.
Homemade Potato Wedges	60	425	③	30-40	
<b>CHICKEN-Frozen</b>					
Frozen Chicken Nuggets, Crispy	30	400	③	15-25	-
Frozen Chicken Strips	35	400	③	25-35	-
Frozen Hot Wings, Bone-in	50	400	③	25-35	-
<b>CHICKEN-Fresh, Skin on</b>					
Fresh Chicken Wings <sup>†</sup>	40	450	③	25-35	Brush or lightly spray with 1 tbsp. of oil. Add salt and pepper to taste.
Fresh Chicken Drumsticks <sup>†</sup>	70	450	③	30-40	
Thighs	40	450	③	25-35	
Breasts	40	450	③	25-35	
<b>OTHER</b>					
Frozen Onion Rings, Breaded	20	400	③	15-25	-
Frozen Spring Rolls (0.7 oz each)	45	400	③	15-25	-
Thin Sausage (2.5 oz each, diameter 0.8")	90	400	③	15-25	-

Recommended Items	Quantity (oz)	Temp. (°F)	Rack Position	Time	Guide
Frozen Coconut Shrimp	25	400	③	15-25	Brush or lightly spray the surface of food with oil.
Fresh Scallops on the half shell (35.3 oz)	35	400	③	15-25	Melt 4 tbsp. of butter and brush on scallops. Mix 1/2 cup bread crumbs, 1 tbsp. minced garlic, 1/4 cup grated parmesan cheese and season to taste. Sprinkle mixture over scallops.
Fresh Shrimp	50	400	③	15-25	-
Mixed Vegetables	35	425	③	13-23	Brush or lightly spray with 4 tbsp. of olive oil. Add salt and pepper to taste.

## Remote Start Mode

If the appliance is connected to a home Wi-Fi network, the preheating function of the oven can be started or stopped using the **LG ThinQ** smartphone app.

## Preparing the Oven for a Remote Start

- 1** Open the oven door to make sure the oven is empty and ready for preheating. Do not place food in the oven. Close the oven door. Remote Start can only be set when the oven door is closed.
- 2** Press **Remote Start**.
- 3** When **Remote Start Ready** appears in the display, the Remote Start function is ready to use.
- 4** Follow the instructions in the **LG ThinQ** smartphone app for using the Remote Start function.

## NOTE

- Remote Start is disconnected in the following situations:
  - Remote Start is never set up in the smartphone app.
  - The Remote Start status is "ready".

- Remote Start experiences a problem during operation.
- The Wi-Fi icon on the display shows the status of the appliance's network connection. If the Wi-Fi icon is not lit, use the smartphone app to select the Wi-Fi network or connect the product again.
- A faulty Wi-Fi connection could delay the Remote Start function.

# SMART FUNCTIONS

## LG ThinQ Application

This feature is only available on models with Wi-Fi.

The **LG ThinQ** application allows you to communicate with the appliance using a smartphone.

### LG ThinQ Application Features

- **Product Upgrades**
  - On models with the **LG UP** Home Appliance feature, experience new features by upgrading the product through the **LG ThinQ** app.
- **Scan to Cook**
  - Scan the barcode on a ready-made meal using the **LG ThinQ** application and send the recommended or customized cooking instructions straight to your oven. **Remote Start** must be activated on the oven to use Scan to Cook.
- **Monitoring**
  - This function helps you check the current status, remaining time, cook settings and end time in one place.
- **Product Notifications**
  - Turn on the Push Alerts to receive appliance status notifications. The notifications are triggered even if the **LG ThinQ** application is not open.
- **Timer**
  - You can set the timer from the application.
- **Settings**
  - Allows you to set various options on the oven and in the application.
- **Smart Diagnosis™**
  - This function provides useful information for diagnosing and solving issues with the appliance based on the pattern of use.
- **Firmware Update**
  - Keep the appliance updated.

#### NOTE

- If you change your wireless router, Internet service provider, or password, delete the connected appliance from the **LG ThinQ** application and connect it again.
- This information is current at the time of publication. The application is subject to change

for product improvement purposes without notice to users.

- Scan to Cook cannot be used while the timer is running. Cancel the timer operation to use Scan to Cook.

### Installing LG ThinQ Application and Connecting an LG Appliance

#### Models with QR Code

Scan the QR code attached to the product using the camera or a QR code reader application on your smartphone.



#### NOTE

- To verify the Wi-Fi connection, check that the Wi-Fi icon on the control panel is lit.
- The appliance supports 2.4 GHz Wi-Fi networks only. To check your network frequency, contact your Internet service provider or refer to your wireless router manual.
- **LG ThinQ** is not responsible for any network connection problems or any faults, malfunctions, or errors caused by network connection.
- The surrounding wireless environment can make the wireless network service run slowly.
- If the distance between the appliance and the wireless router is too far, the signal becomes weak. It may take a long time to connect or fail to install the application.
- If the appliance is having trouble connecting to the Wi-Fi network, it may be too far from the router. Purchase a Wi-Fi repeater (range extender) to improve the Wi-Fi signal strength.
- The network connection may not work properly depending on the Internet service provider.
- The Wi-Fi may not connect or the connection may be interrupted because of the home network environment.

**NOTE**

- If the appliance cannot be connected due to problems with the wireless signal transmission, unplug the appliance and wait about a minute before trying again.
- If the firewall on your wireless router is enabled, disable the firewall or add an exception to it.
- The wireless network name (SSID) should be a combination of English letters and numbers. (Do not use special characters.)
- Smartphone user interface (UI) may vary depending on the mobile operating system (OS) and the manufacturer.
- If the security protocol of the router is set to **WEP**, network setup may fail. Change the security protocol (**WPA2** is recommended), and connect the product again.
- To reconnect the appliance or add another user, press and hold the **Wi-Fi** button for 3 seconds. Run the **LG ThinQ** application and follow the instructions in the application to connect the appliance.

**RF Module Specifications**

Type	Frequency Range	Output Power (Max.)
Wi-Fi	2412 - 2462 MHz	< 30 dBm
Bluetooth	2402 - 2480 MHz	< 30 dBm

**FCC Notice**

The following notice covers the transmitter module contained in this product.

This equipment has been tested and found to comply with the limits for a Class B digital device, pursuant to Part 15 of the FCC Rules. These limits are designed to provide reasonable protection against harmful interference in a residential installation. This equipment generates, uses, and can radiate radio frequency energy and, if not installed and used in accordance with the instructions, may cause harmful interference to radio communications. However, there is no guarantee that interference will not occur in a particular installation. If this equipment does cause harmful interference to radio or television reception, which can be determined by turning the equipment off and on, the user is encouraged to

try to correct the interference by one or more of the following measures:

- Reorient or relocate the receiving antenna.
- Increase the separation between the equipment and the receiver.
- Connect the equipment into an outlet on a circuit different from that to which the receiver is connected.
- Consult the dealer or an experienced radio/TV technician for help.

This device complies with part 15 of the FCC Rules. Operation is subject to the following two conditions:

(1) This device may not cause harmful interference and

(2) This device must accept any interference received, including interference that may cause undesired operation.

Any changes or modifications in construction of this device which are not expressly approved by the party responsible for compliance could void the user's authority to operate the equipment.

**FCC RF Radiation Exposure Statement**

This equipment complies with FCC radiation exposure limits set forth for an uncontrolled environment. This transmitter must not be co-located or operating in conjunction with any other antenna or transmitter.

This equipment should be installed and operated with a minimum distance of 20 cm (7.8 inches) between the antenna and your body. Users must follow the specific operating instructions for satisfying RF exposure compliance.

**Open Source Software Notice Information**

To obtain the source code that is contained in this product, under GPL, LGPL, MPL, and other open source licenses that have the obligation to disclose source code, and to access all referred license terms, copyright notices and other relevant documents, please visit <https://opensource.lge.com>.

LG Electronics will also provide open source code to you on CD-ROM for a charge covering the cost of performing such distribution (such as the cost of media, shipping, and handling) upon email request to [opensource@lge.com](mailto:opensource@lge.com).

This offer is valid to anyone in receipt of this information for a period of three years after our last shipment of this product.

## Smart Diagnosis™ Feature

Use this feature to help you diagnose and solve problems with your appliance.

### NOTE

- For reasons not attributable to LGE's negligence, the service may not operate due to external factors such as, but not limited to, Wi-Fi unavailability, Wi-Fi disconnection, local app store policy, or app unavailability.
- The feature may be subject to change without prior notice and may have a different form depending on where you are located.

- 3 Keep the phone in place until the tone transmission has finished. The display will count down the time. Once the countdown is over and the tones have stopped, the diagnosis will be displayed in the application.

### NOTE

- For best results, do not move the phone while the tones are being transmitted.

## Using LG ThinQ to Diagnose Issues

If you experience a problem with your Wi-Fi equipped appliance, it can transmit troubleshooting data to a smartphone using the **LG ThinQ** application.

- Launch the **LG ThinQ** application and select the **Smart Diagnosis** feature in the menu. Follow the instructions provided in the **LG ThinQ** application.

## Using Audible Diagnosis to Diagnose Issues

Follow the instructions below to use the audible diagnosis method.

- Launch the **LG ThinQ** application and select the **Smart Diagnosis** feature in the menu. Follow the instructions for audible diagnosis provided in the **LG ThinQ** application.

- 1 Press the **START** button for 3 seconds.
  - If the display has been locked, you must deactivate the lock and then reactivate it.
- 2 Hold the mouthpiece of your phone in front of the control panel, as shown below.

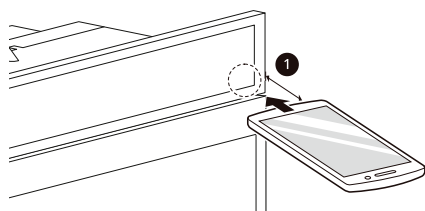

- 1 Max: 3/8" (10 mm)

# MAINTENANCE

## Cleaning

### Interior

Do not use oven cleaners to clean the oven cavity. Use the product's **EasyClean** function regularly to clean light soil. For stubborn soil, use the **Self Clean** function (on some models) or clean manually using the following tips.

- A plastic spatula can be used as a scraper to scrape off any chunks or debris before and during oven cleaning.
- Using the rough side of a non-scratch scouring pad may help to take off burnt-on stains better than a soft sponge or towel.
- Certain non-scratch scrubbing sponges, such as those made of melamine foam, available at local stores, can also help improve cleaning.

---

#### CAUTION

- Do not use oven cleaners, harsh chemical cleaners, bleach, vinegar, steel scouring pads, or abrasive pads or cleansers to clean the oven, as they can permanently damage the oven surface.
  - Do not clean the gasket.
- 

### Exterior

#### Painted and Decorative Trim

For general cleaning, use a cloth with hot soapy water. For more difficult soils and built-up grease, apply a liquid detergent directly onto the soil. Leave it on for 30 to 60 minutes. Rinse with a damp cloth and dry. Do not use abrasive cleaners.

#### Stainless Steel Surfaces

To avoid scratches, do not use steel wool pads.

- 1** Place a small amount of stainless steel appliance cleaner or polish on a damp cloth or paper towel.
- 2** Clean a small area, rubbing with the grain of the stainless steel if applicable.
- 3** Dry and buff with a clean, dry paper towel or soft cloth.

- 4** Repeat as necessary.

---

#### NOTE

- To clean the stainless steel surface, use warm sudsy water or a stainless steel cleaner or polish.
  - Always wipe in the direction of the metal surface finish.
  - Stainless steel appliance cleaner or polish can be purchased online or from most retailers of appliances or home goods.
- 

#### Oven Cavity

DO NOT use oven cleaners.

NEVER wipe a warm or hot porcelain surface with a damp sponge; it may cause chipping or crazing (tiny hairlike cracks). Food spills should be cleaned when the oven cools. At high temperature, foods react with porcelain and a permanent dull spot can result. When cleaning a spot, use only non-abrasive cleaners or scrubbers.

#### Oven Door

---

#### CAUTION

- Do not use harsh cleaners or harsh abrasive cleaning materials on the outside of the oven door. Doing so can cause damage.
- Use soapy water to thoroughly clean the oven door. Rinse well. Do not immerse the door in water.
- You may use a glass cleaner on the outside glass of the oven door. Do not spray water or glass cleaner on the door vents.
- Do not use oven cleaners, cleaning powders, or harsh abrasive cleaning materials on the outside of the oven door.
- Do not clean the oven door gasket. The oven door gasket is made of a woven material that is



essential for a good seal. Care should be taken not to rub, damage, or remove this gasket.

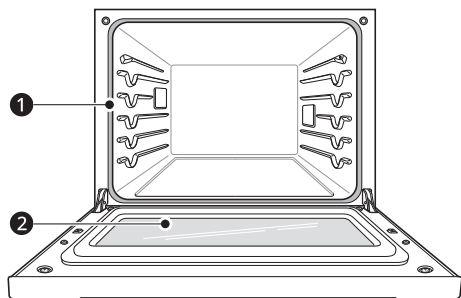

- ❶ Don't hand clean oven door gasket
- ❷ Do hand clean door

### Broiler Pan and Grid

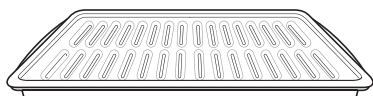

- Do not store a soiled broiler pan or grid anywhere in the appliance.
- Do not clean the broiler pan or grid in a self cleaning mode. (Available on some models)
- Remove the grid from the pan. Carefully pour out the grease from the pan into a proper container.
- Wash and rinse the broiler pan and grid in hot water with a soap-filled or plastic scouring pad.
- If food has burned on, sprinkle the grid with cleaner while hot and cover with wet paper towels or a dishcloth. Soaking the pan will remove burned-on foods.
- Both the broiler pan and grid may be cleaned with a commercial oven cleaner or in the dishwasher.

### Oven Racks

Remove the oven racks before operating the **Self Clean** cycle and **EasyClean**.

- 1 Clean with a mild, abrasive cleaner.
  - Food spilled into the tracks could cause the racks to become stuck.
- 2 Rinse with clean water and dry.

#### NOTE

If the racks are cleaned using the **Self Clean** cycle (not recommended), the color will turn slightly blue and the finish will become dull. After the **Self**

**Clean** cycle is complete, and the oven has cooled, rub the sides of the racks with wax paper or a cloth containing a small amount of vegetable oil. This will make the racks glide more easily into the rack tracks.

### EasyClean

LG's **EasyClean** enamel technology provides two cleaning options for the inside of the oven. The **EasyClean** feature takes advantage of LG's new enamel to help lift soils without harsh chemicals, and it runs using **ONLY WATER** for just 10 minutes in low temperatures to help loosen **LIGHT** soils before hand cleaning.

While **EasyClean** is quick and effective for small and **LIGHT** soils, the **Self Clean** feature can be used to remove **HEAVY**, built up soils. The intensity and high heat of the **Self Clean** cycle may result in smoke which will require the opening up of windows to provide ventilation. Compared to the more intense **Self Clean** process, your LG oven gives you the option of cleaning with **LESS HEAT**, **LESS TIME**, and virtually **NO SMOKE OR FUMES**. You can reduce energy use by cleaning light oven soils with the **EasyClean** feature instead of **Self Clean**.

When needed, the oven still provides the **Self Clean** option for longer, more thorough oven cleaning for heavier, built up soils.

- For hard to reach areas such as the back surface of the oven, it is better to use the **Self Clean** cycle.

### Benefits of EasyClean

- Helps loosen light soils before hand-cleaning
- **EasyClean** only uses water; no chemical cleaners
- Makes for a better **Self Clean** experience.
  - Delays the need for a **Self Clean** cycle
  - Minimizes smoke and odors
  - Can allow shorter **Self Clean** time

#### NOTE

- For models without **Self Clean** option
  - The **EasyClean** feature may not be effective in removing heavy, built-up soils. Because the oven does not include a **Self Clean** option, clean the oven regularly using the **EasyClean** feature to prevent heavy, burnt-on soil from building up in the oven.

## When to Use EasyClean

- Example of oven soiling

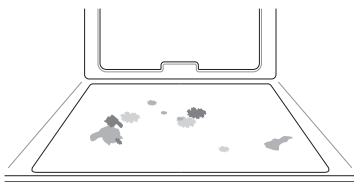

### Case 1

- Soil pattern: Small drops or spots
- Types of soils: Cheese or other ingredients
- Common food items that can soil your oven: Pizza

### Case 2

- Soil pattern: Light splatter
- Types of soils: Fat/grease
- Common food items that can soil your oven: Steaks, broiled / Fish, broiled / Meat roasted at low temperatures

## EasyClean Instruction Guide

### NOTE

- Allow the oven to cool to room temperature before using the **EasyClean** cycle. If your oven cavity is above 150 °F (65 °C), the **EasyClean** cycle will not be activated until the oven cavity cools down.
- The oven should be level to ensure that the bottom surface of the oven cavity is entirely covered by water at the beginning of the **EasyClean** cycle.
- For best results, use distilled or filtered water. Tap water may leave mineral deposits on the oven bottom.
- Soil baked on through several cooking cycles will be more difficult to remove with the **EasyClean** cycle.
- Do not open the oven door during the **EasyClean** cycle. Water will not get hot enough if the door is opened during the cycle.

**1** Remove oven racks and accessories from the oven.

**2** Scrape off and remove any burnt-on debris with a plastic scraper.

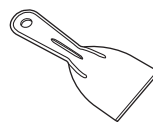

- Suggested plastic scrapers:
  - Hard plastic spatula
  - Plastic pan scraper
  - Plastic paint scraper
  - Old credit card

**3** Fill a spray bottle (10 oz or 300 ml) with water and use the spray bottle to thoroughly spray the inside surfaces of the oven.

**4** Use at least 1/5 (2 oz or 60 ml) of the water in the bottle to completely saturate the soil on both the walls and in the corners of the oven.

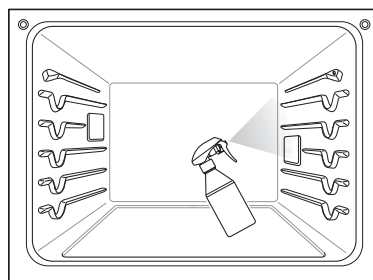

**5** Spray or pour the remaining water (8 oz or 240 ml) onto the bottom center of the oven cavity. The indentation on the oven bottom should be fully covered to submerge all soils. Add water if necessary.

### NOTE

- If cleaning multiple ovens, use an entire bottle of water to clean each oven. Do not spray water directly on the door. Doing so will result in water dripping to the floor.

**6** Close the oven door. Press **EasyClean**. Press **START**.

### ⚠ CAUTION

- Some surfaces may be hot after the **EasyClean** cycle. Wear rubber gloves while cleaning to prevent burns.

- During the **EasyClean** cycle, the oven becomes hot enough to cause burns. Wait until the cycle is over before wiping the inside surface of the oven. Failure to do so may result in burns.
- Avoid leaning or resting on the oven door glass while cleaning the oven cavity.

**7** A tone will sound at the end of the 10 minute cycle. Press **CLEAR/OFF** to clear the display and end the tone.

**8** After the cleaning cycle and during hand-cleaning, enough water should remain on the oven bottom to completely submerge all soils. Add water if necessary. Place a towel on the floor in front of the oven to capture any water that may spill out during hand-cleaning.

**9** Clean the oven cavity immediately after the **EasyClean** cycle by scrubbing with a wet, non-scratch scouring sponge or pad. (The scouring side will not scratch the finish.) Some water may spill into the bottom vents while cleaning, but it will be captured in a pan under the oven cavity and will not hurt the burner.

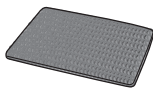

**NOTE**

- Do not use any steel scouring pads, abrasive pads or cleaners as these materials can permanently damage the oven surface.

**10** Once the oven cavity is cleaned, wipe any excess water with a clean dry towel. Replace racks and any other accessories.

**11** If some light soils remain, repeat the above steps, making sure to thoroughly soak the soiled areas.

- If stubborn soils remain after multiple **EasyClean** cycles, run the **Self Clean** cycle. Be sure that the oven cavity is empty of oven racks and other accessories, and that the oven cavity surface is dry before running the **Self Clean** cycle. Consult the **Self Clean** section of your owner's manual

for further details. If a **Self Clean** option is not available, scrape off and remove stubborn soil using a scraper.

**NOTE**

- If you forget to saturate the inside of the oven with water before starting **EasyClean**, press **CLEAR/OFF** to end the cycle. Wait for the oven to cool to room temperature and then spray or pour water into the oven and start another **EasyClean** cycle.
- The cavity gasket may be wet when the **EasyClean** cycle finishes. This is normal. Do not clean the gasket.
- If mineral deposits remain on the oven bottom after cleaning, use a cloth or sponge soaked in vinegar to remove them.
- It is normal for the fan to operate during the **EasyClean** cycle.
- Using commercial oven cleaners or bleach to clean the oven is not recommended. Instead, use a mild liquid cleanser with a pH value below 12.7 to avoid discoloring the enamel.

**Self Clean**

The **Self Clean** cycle uses extremely hot temperatures to clean the oven cavity. While running the **Self Clean** cycle, you may notice smoking or an odor. This is normal, especially if the oven is heavily soiled. During **Self Clean**, the kitchen should be well ventilated to minimize the odors from cleaning.

**Before Starting Self Clean**

- Clean only parts listed in manual. Remove the oven racks, broiler pan, broiler grid, all cookware, aluminum foil or any other material from the oven.
  - If oven racks are left in the oven cavity during the **Self Clean** cycle, they will discolor and become difficult to slide in and out.
- The kitchen should be well ventilated to minimize the odors from cleaning. Open a window or turn on a ventilation fan or hood before self-cleaning.
- Wipe any heavy spillovers on the bottom of the oven.
- Make sure that the oven light cover is in place and the oven light is off.
- Clean the frame of the oven and door with hot soapy water. Rinse well.

**⚠ WARNING**

- If the oven is heavily soiled with oil, self-clean the oven before using the oven again. The oil could cause a fire.
  - If there is a fire in the oven during self-clean, turn the oven off and wait for the fire to go out. Do not force the door open. Introduction of fresh air at self-clean temperatures may lead to a burst of flame from the oven. Failure to follow this instruction may result in severe burns.
- 

**⚠ CAUTION**

- Do not use oven cleaners. Commercial oven cleaner or oven liner protective coating of any kind should not be used in or around any part of the oven.
  - The oven displays an F error code and sounds three long beeps during the self-cleaning process if it malfunctions in the self-clean mode. Switch off the electrical power to the main fuse or breaker and have the oven serviced by a qualified technician.
  - If the self cleaning mode malfunctions, turn the oven off and disconnect the power supply. Have it serviced by a qualified technician.
  - It is normal for parts of the oven to become hot during a **Self Clean** cycle. Avoid touching the door, window or oven vent area during a **Self Clean** cycle.
  - Do not leave small children unattended near the appliance. During the **Self Clean** cycle, the outside of the oven can become very hot to the touch.
  - If you have pet birds, move them to another well-ventilated room. The health of some birds is extremely sensitive to the fumes given off during the **Self Clean** cycle of any oven.
  - Do not line the oven walls, racks, bottom or any other part of the oven with aluminum foil or any other material. Doing so will destroy heat distribution, produce poor baking results and cause permanent damage to the oven interior (aluminum foil will melt to the interior surface of the oven).
  - Do not force the door open. This can damage the automatic door locking system. Use care when opening the oven door after the **Self Clean** cycle. Stand to the side of the oven when opening the door to allow hot air or steam to escape. The oven may still be VERY HOT.
- 

**NOTE**

- The oven light cannot be turned on during a **Self Clean** cycle. The oven light cannot be turned on until the oven temperature has cooled below 500 °F (260 °C) after a **Self Clean** cycle is complete.
  - Clean the frame of the oven and door with hot soapy water. Rinse well.
  - Do not clean the gasket. The fiberglass material of the oven door gasket cannot withstand abrasion. It is essential for the gasket to remain intact. If you notice it becoming worn or frayed, replace it.
  - It is normal for the fan to operate during the **Self Clean** cycle.
  - As the oven heats, you may hear sounds of metal parts expanding and contracting. This is normal and will not damage the oven.
  - You may notice some white ash in the oven. Wipe it off with a damp cloth or a soap-filled steel wool pad after the oven cools. If the oven is not clean after one **Self Clean** cycle, repeat the cycle.
  - If oven racks were left in the oven and do not slide smoothly after a **Self Clean** cycle, wipe racks and rack supports with a small amount of vegetable oil to make them glide more easily.
  - After a **Self Clean** cycle, fine lines may appear in the porcelain because it went through heating and cooling. This is normal and will not affect performance.
  - The **Self Clean** cycle cannot be started if the **Control Lock** feature is active.
  - Once the **Self Clean** cycle is set, the oven door locks automatically. You will not be able to open the oven door until the oven is cooled. The lock releases automatically.
  - Once the door has been locked, the lock  indicator light stops flashing and remains on. Allow about 15 seconds for the oven door lock to activate.
  - If the clock is set for a 12-hour display (default) the Delayed **Self Clean** can never be set to start more than 12 hours in advance.
  - After the oven is turned off, the convection fan keeps operating until the oven has cooled down.
-

## When to Use Self Clean

- Example of oven soiling

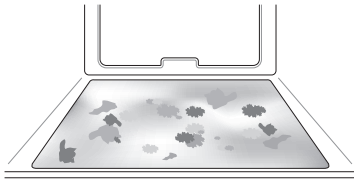

### Case 1

- Soil pattern: Medium to heavy splatter
- Types of soils: Fat/grease
- Common food items that can soil your oven: Meat roasted at high temperatures

### Case 2

- Soil pattern: Drops or spots
- Types of soils: Filling or sugar based soils
- Common food items that can soil your oven: Pies

### Case 3

- Soil pattern: Drops or spots
- Types of soils: Cream or tomato sauce
- Common food items that can soil your oven: Casseroles

### NOTE

- The **Self Clean** cycle can be used for soil that has been built up over time.

## Setting Self Clean

The **Self Clean** function has cycle times of 3, 4, or 5 hours.

### Self Clean Soil Guide

Soil Level	Cycle Setting
Lightly Soiled Oven Cavity	3-Hour
Moderately Soiled Oven Cavity	4-Hour
Heavily Soiled Oven Cavity	5-Hour

- 1 Remove all racks and accessories from the oven.

- 2 Press **Self Clean**.  
The oven defaults to the recommended four-hour self clean for a moderately soiled oven.
- 3 Press **Self Clean** repeatedly to set the time settings.
- 4 If desired, press **Start Time** to set the delayed start time. Press the numbers to set the time settings.
- 5 Press **START**. The remaining time or the delayed start time appears in the display.
- 6 Once the self-clean cycle is set, the oven door locks automatically and the lock icon displays.
  - You will not be able to open the oven door until the oven has cooled. The lock releases automatically when the oven has cooled.

### CAUTION

- Do not force the oven door open when the lock icon is displayed. The oven door remains locked until the oven temperature has cooled. Forcing the door open will damage the door.
- It may become necessary to cancel or interrupt a **Self Clean** cycle due to excessive smoke or fire in the oven. To cancel the **Self Clean** function, press **CLEAR / OFF**.

## During Self Clean

- The **Self Clean** cycle uses extremely hot temperatures to clean the oven cavity. While running the **Self Clean** cycle, you may notice smoking or an odor. This is normal, especially if the oven is heavily soiled.
- As the oven heats, you may hear sounds of metal parts expanding and contracting. This is normal and will not damage the oven.
- Do not force the oven door open when the lock icon is displayed. The oven door remains locked until the oven temperature has cooled. Forcing the door open will damage the door.

## After the Self Clean Cycle

- The oven door remains locked until the oven temperature has cooled.
- You may notice some white ash in the oven. Wipe it off with a damp cloth or a soap-filled pad

after the oven cools. If the oven is not clean after one self-clean cycle, repeat the cycle.

- If oven racks were left in the oven and do not slide smoothly after a self-clean cycle, wipe racks and rack supports with a small amount of vegetable oil to make them glide more easily.
- Fine lines may appear in the porcelain because it went through heating and cooling. This is normal and will not affect performance.

## Periodic Maintenance

### Changing the Oven Light

The oven light is a standard 25-watt halogen bulb for ovens.

#### **⚠ WARNING**

- Make sure that the oven and bulb are cool.
- Disconnect the electrical power to the appliance at the main fuse or circuit breaker panel. Failure to do so can result in severe personal injury, death, or electrical shock.
- Wear gloves while changing the oven light. Glass fragments from broken bulbs can cause risk of injury.
- Gently twist the screwdriver blade while changing the oven light. If you apply force, the glass or oven may crack.

- 1 Unplug the oven or disconnect power.
- 2 Remove the oven racks.
- 3 Slide a flat blade screwdriver **1** between the housing and the glass light cover **2**.

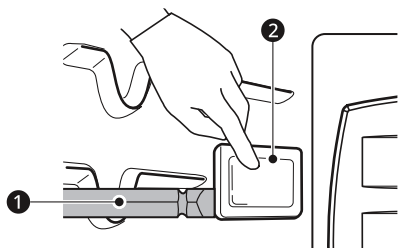

- 4 Support the glass light cover with two fingers to prevent the cover from falling to the bottom of the oven.

- 5 Gently twist the screwdriver blade to loosen the glass light cover **3**.

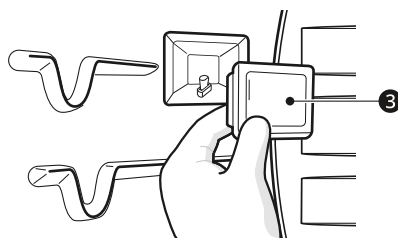

- 6 Remove the bulb from the socket.
- 7 Replace the bulb, and reassemble the light cover by snapping it back into place.
- 8 Plug in the oven or reconnect power.

# TROUBLESHOOTING

## FAQs

### Frequently Asked Questions

**Q: My new oven doesn't cook like my old one. Is there something wrong with the temperature settings?**

A: No. Your oven has been factory tested and calibrated. For the first few uses, follow your recipe times and temperatures carefully. If you still think your new oven is too hot or too cold, you can adjust the oven temperature yourself to meet your specific cooking needs. Refer to the **Changing Settings** section in this manual for easy instructions on how to adjust your thermostat.

**Q: Is it normal to hear a clicking noise coming from the back of my oven when I am using it?**

A: Your new appliance is designed to maintain a tighter control over your oven's temperature. You may hear your oven's heating elements click on and off more frequently on your new oven. This is normal.

**Q: During convection cooking the fan stops when I open the door. Is that normal?**

A: Yes, this is normal. When the door is opened, the convection fan will stop until the door is closed.

**Q: Can I use aluminum foil to catch drippings in my oven cavity?**

A: Never use aluminum foil to line the bottom or sides of the oven. The foil will melt and stick to the bottom surface of the oven and will not be removable. Use a foil-lined sheet pan placed on a lower oven rack to catch drippings instead. (If foil has already melted onto the bottom of the oven, it will not interfere with the oven's performance.)

**Q: Can I use aluminum foil on the racks?**

A: Do not cover racks with aluminum foil. Covering entire racks with foil restricts air flow, leading to poor cooking results. Use a sheet pan lined with foil under fruit pies or other acidic or sugary foods to prevent spillovers from damaging the oven finish.

### CAUTION

- Foil may be used to wrap food in the oven, but do not allow the foil to come into contact with the exposed heating/broiling elements in the oven. The foil could melt or ignite, causing smoke, fire, or injury.

**Q: Can I leave my racks in the oven when running a Self Clean cycle?**

A: No. Although it will not damage the racks, it will discolor them and may make them hard to slide in and out during use. Remove all items from the oven before starting a **Self Clean** cycle.

**Q: What should I do if my racks are sticky and have become hard to slide in and out?**

A: Over time, the racks may become hard to slide in and out. Apply a small amount of olive oil to the sides of the racks. This will work as a lubricant for easier gliding.

**Q: Should I broil with the door open or closed?**

A: Your oven isn't designed for open door broiling. If you broil with the oven door open, it can damage the display.

**Q: Why aren't the function buttons working?**

A: Make sure that the appliance is not in **Control Lock** mode. The lock  will show in the display if **Control Lock** is activated. To deactivate **Control Lock**, refer to the **Control Lock** section. The unlock melody sounds and **Loc** appears in the display until the controls are unlocked.

**Q: My appliance is still dirty after running the EasyClean cycle. What else should I do?**

A: The **EasyClean** cycle only helps to loosen light soils in your appliance to assist in hand-cleaning of your oven. It does not automatically remove all soils after the cycle. Some scrubbing of your appliance is required after running the **EasyClean** cycle.

**Q: I tried scrubbing my oven after running EasyClean, but some soils still remain. What can I do?**

A: The **EasyClean** feature works best when the soils are fully soaked and submerged in water before running the cycle and during hand-cleaning. If soils are not sufficiently soaked in water, it can negatively affect the cleaning performance. Repeat the **EasyClean** process using sufficient water. Sugar-based and certain greasy soils are especially hard to clean. If some stubborn soils remain, use the **Self Clean** feature to thoroughly clean your oven.

**Q: Soils on my oven walls are not coming off. How can I get the oven walls clean?**

A: Soils on the side and rear walls of your appliance may be more difficult to fully soak with water. Try repeating the **EasyClean** process with more than the  $\frac{1}{4}$  cup (2 oz or 60 ml) of spray recommended.

**Q: Will EasyClean get all of the soils and stains out completely?**

A: It depends on the soil type. Sugar-based and certain grease stains are especially hard to clean. Also, if stains are not sufficiently soaked in water, this can negatively affect cleaning performance. If stubborn or built-up stains remain, use the **Self Clean** feature. Refer to the **Self Clean** section of your owner's manual.

**Q: Are there any tricks to getting some of the stubborn soils out?**

A: Scraping the soils with a plastic scraper before and during hand-cleaning is recommended. Fully saturating soils with water is also recommended. However, certain types of soils are harder to clean than others. For these stubborn soils, the **Self Clean** cycle is recommended. Consult the **Self Clean** section of your owner's manual for details.

**Q: Is it safe for my convection fan or heater element to get wet during EasyClean?**

A: Yes. The convection fan or heater element may get a little wet during cleaning. However, direct spray onto the broil burner and heater elements is not necessary because these are self-cleaning during regular use.

**Q: Do I need to use all 1  $\frac{1}{4}$  cups (10 oz or 300 ml) of water for EasyClean?**

A: Yes. It is highly recommended that 1 cup (8 oz or 240 ml) of water be sprayed or poured on the bottom and an additional  $\frac{1}{4}$  cup (2 oz or 60 ml) of water be sprayed on walls and other soiled areas to fully saturate the soils for better cleaning performance.

**Q: I see smoke coming out of my appliance's vents during EasyClean. Is this normal?**

A: This is normal. This is not smoke. It is actually water vapor (steam) from the water in the oven cavity. As the oven heats briefly during **EasyClean**, the water in the cavity evaporates and escapes through the oven vents.

**Q: How often should I use EasyClean?**

A: **EasyClean** can be performed as often as you wish. **EasyClean** works best when your oven is LIGHTLY soiled from such things as LIGHT grease splatter and small drops of cheese. Please refer to the **EasyClean** section in your owner's manual for more information.

**Q: What is required for EasyClean?**

A: A spray bottle filled with 1  $\frac{1}{4}$  cups (10 oz or 300 ml) of water, a plastic scraper, a non-scratch scrubbing pad and a towel. You should not use abrasive scrubbers such as heavy-duty scouring pads or steel wool.



## Before Calling for Service

Review this section before calling for service; doing so will save you both time and money.

### Cooking

Problem	Possible Cause & Solution
<b>Oven will not work</b>	<b>Plug on appliance is not completely inserted in the electrical outlet.</b> <ul style="list-style-type: none"> <li>Make sure electrical plug is plugged into a live, properly grounded outlet.</li> </ul>
	<b>A fuse in your home may be blown or the circuit breaker tripped.</b> <ul style="list-style-type: none"> <li>Replace the fuse or reset the circuit breaker.</li> </ul>
	<b>Oven controls improperly set.</b> <ul style="list-style-type: none"> <li>See the "Operating the Oven" section in the Operation chapter.</li> </ul>
	<b>Oven too hot.</b> <ul style="list-style-type: none"> <li>Allow the oven to cool to below locking temperature.</li> </ul>
<b>Steam is exhausted through the oven vent.</b>	<b>Cooking foods with high moisture produces steam.</b> <ul style="list-style-type: none"> <li>This is normal.</li> </ul>
<b>Appliance does not operate.</b>	<b>Cord is not plugged in correctly.</b> <ul style="list-style-type: none"> <li>Make sure cord is plugged correctly into outlet. Check circuit breakers.</li> </ul>
	<b>Service wiring is not complete.</b> <ul style="list-style-type: none"> <li>Contact your electrician for assistance.</li> </ul>
	<b>Power outage.</b> <ul style="list-style-type: none"> <li>Check house lights to be sure. Call your local electric company for service.</li> </ul>
<b>Oven smokes excessively during broiling.</b>	<b>Control not set properly.</b> <ul style="list-style-type: none"> <li>Follow instructions under Setting Oven Controls.</li> </ul>
	<b>Meat too close to the element.</b> <ul style="list-style-type: none"> <li>Reposition the rack to provide proper clearance between the meat and the element. Preheat broil element for searing.</li> </ul>
	<b>Meat not properly prepared.</b> <ul style="list-style-type: none"> <li>Remove excess fat from meat. Cut remaining fatty edges to prevent curling.</li> </ul>
	<b>Insert on broiler pan wrong side up and grease not draining.</b> <ul style="list-style-type: none"> <li>Always place the grid on the broiler pan with ribs up and slots down to allow grease to drip into the pan.</li> </ul>
	<b>Grease has built up on oven surfaces. Old grease or food spatters cause excessive smoking.</b> <ul style="list-style-type: none"> <li>Regular cleaning is necessary when broiling frequently.</li> </ul>
<b>Food does not bake or roast properly</b>	<b>Oven controls improperly set.</b> <ul style="list-style-type: none"> <li>See the "Operating the Oven" section in the Operation chapter.</li> </ul>
	<b>Rack position is incorrect or the rack is not level.</b> <ul style="list-style-type: none"> <li>See the "Operating the Oven" section in the Operation chapter.</li> </ul>
	<b>Incorrect cookware or cookware of improper size being used.</b> <ul style="list-style-type: none"> <li>See the "Operating the Oven" section in the Operation chapter.</li> </ul>
	<b>Oven sensor needs to be adjusted.</b> <ul style="list-style-type: none"> <li>See the "Adjusting the Oven Temperature" section in the Operation chapter.</li> </ul>

Problem	Possible Cause & Solution
<b>Food does not broil properly</b>	<b>Oven controls improperly set.</b> <ul style="list-style-type: none"> <li>• Make sure you select the <b>Broil</b> mode properly.</li> </ul>
	<b>Improper rack position being used.</b> <ul style="list-style-type: none"> <li>• See the Broiling Guide.</li> </ul>
	<b>Cookware not suited for broiling.</b> <ul style="list-style-type: none"> <li>• Use broiling pan and grid.</li> </ul>
	<b>Aluminum foil used on the broiling pan and grid has not been fitted properly and slit as recommended.</b> <ul style="list-style-type: none"> <li>• See the "Operating the Oven" section in the Operation chapter.</li> </ul>
	<b>In some areas the power voltage may be low.</b> <ul style="list-style-type: none"> <li>• Preheat the broil element for 5-7 minutes. See the Broiling Guide.</li> </ul>
<b>Oven temperature too hot or too cold</b>	<b>Oven sensor needs to be adjusted.</b> <ul style="list-style-type: none"> <li>• See the "Temperature Adjustment" section in the Operation chapter.</li> </ul>
<b>Excessive smoking during a Self Clean cycle</b>	<b>Excessive soil.</b> <ul style="list-style-type: none"> <li>• Turn off the Self Clean function. Open the windows to rid the room of smoke. Wait until the Self Clean mode is cancelled. Wipe up the excess soil and reset the self clean.</li> </ul>
<b>Burning or oily odor emitting from the vent</b>	<b>This is normal in a new oven.</b> <ul style="list-style-type: none"> <li>• This will disappear in time. To speed the process, set a Self Clean cycle for a minimum of 3 hours. See the Self Clean section. (On some models)</li> </ul>
<b>Moisture collects on oven window or steam comes from oven vent</b>	<b>This happens when cooking foods high in moisture.</b> <ul style="list-style-type: none"> <li>• This is normal.</li> </ul>
	<b>A very wet cloth was used when cleaning the window.</b> <ul style="list-style-type: none"> <li>• Do not use too much water when cleaning the window.</li> </ul>
<b>Warm air venting into kitchen after oven has been turned off.</b>	<b>Warm air exhaust is needed to maintain and cool down oven temperatures. It turns off automatically when the heat cools to a safe temperature.</b> <ul style="list-style-type: none"> <li>• This is normal.</li> </ul>

## Parts & Features

Problem	Possible Cause & Solution
<b>Oven control beeps and displays any F code error.</b>	<b>Electronic control has detected a fault condition.</b> <ul style="list-style-type: none"> <li>• Turn off the oven function you are using to clear the display and stop beeping. Reprogram oven. If fault recurs, record fault number and call for service.</li> </ul> <p>[Case 1]</p> <ul style="list-style-type: none"> <li>- Code: F-3</li> <li>- Cause: Key short error</li> </ul> <p>[Case 2]</p> <ul style="list-style-type: none"> <li>- Code: F-9</li> <li>- Cause: Oven not heating</li> </ul>
<b>Displayed colon in the clock is flashing.</b>	<b>This means that the product has just been plugged in, or that it has experienced a power interruption.</b> <ul style="list-style-type: none"> <li>• This is normal. Reset the clock or press any button to stop the flashing.</li> </ul>
<b>CLEAN and door flash in the display.</b>	<b>The Self Clean cycle has been selected, but the door is not closed.</b> <ul style="list-style-type: none"> <li>• Close the oven door.</li> </ul>

Problem	Possible Cause & Solution
Loc is on in the display when you want to cook.	<p><b>The oven is locked because of the Control Lock feature.</b></p> <ul style="list-style-type: none"> <li>Deactivate the <b>Control Lock</b> feature.</li> </ul>
Oven light does not work.	<p><b>It is time to replace the lamp or the lamp is loose.</b></p> <ul style="list-style-type: none"> <li>Replace or tighten lamp. See <b>Changing the Oven Light</b> section in this Owner's Manual.</li> </ul>
Convection fan stops. (During Conv.Bake mode)	<p><b>Convection fan stops during a convection bake cycle. It is done to allow for more even heating during the cycle.</b></p> <ul style="list-style-type: none"> <li>This is not a failure of the appliance and should be considered normal operation.</li> </ul>
Fan operation (During Bake mode)	<p><b>This is to ensure even baking results.</b></p> <ul style="list-style-type: none"> <li>It is normal for the fan to operate periodically throughout a normal bake cycle in the oven.</li> </ul>
Oven will not Self Clean.	<p><b>The oven temperature is too high to set a Self Clean operation.</b></p> <ul style="list-style-type: none"> <li>Allow the oven to cool and reset the controls.</li> </ul>
	<p><b>Oven controls improperly set.</b></p> <ul style="list-style-type: none"> <li>See the <b>Self Clean</b> section.</li> </ul>
	<p><b>A Self Clean cycle cannot be started if the oven Control Lock feature is active.</b></p> <ul style="list-style-type: none"> <li>See the <b>Changing Settings</b> section.</li> </ul>
Oven door does not open after a Self Clean cycle.	<p><b>Oven is too hot.</b></p> <ul style="list-style-type: none"> <li>Allow the oven to cool below locking temperature.</li> </ul>
	<p><b>The control and door may be locked.</b></p> <ul style="list-style-type: none"> <li>Allow about one hour for the oven to cool after the completion of a <b>Self Clean</b> cycle. The door can be opened when the lock  is no longer displayed.</li> </ul>
The oven is not clean after a Self Clean cycle.	<p><b>Oven controls not properly set.</b></p> <ul style="list-style-type: none"> <li>See the <b>Self Clean</b> section.</li> </ul>
	<p><b>Oven was heavily soiled.</b></p> <ul style="list-style-type: none"> <li>Clean up heavy spillovers before starting the clean cycle. Heavily soiled ovens may need to <b>Self Clean</b> again or for a longer period of time.</li> </ul>
Oven racks are difficult to slide.	<p><b>The shiny, silver-colored racks were cleaned in a Self Clean cycle.</b></p> <ul style="list-style-type: none"> <li>Apply a small amount of vegetable oil to a paper towel and wipe the edges of the oven racks with the paper towel.</li> </ul>

## Noises

Problem	Possible Cause & Solution
"Crackling" or "popping" sound	<p><b>This is the sound of the metal heating and cooling during both the cooking and Self Clean functions.</b></p> <ul style="list-style-type: none"> <li>This is normal.</li> </ul>
Fan noise	<p><b>A convection fan may automatically turn on and off.</b></p> <ul style="list-style-type: none"> <li>This is normal.</li> </ul>

## Wi-Fi

Problem	Possible Cause & Solution
<b>Trouble connecting appliance and smartphone to Wi-Fi network</b>	<b>The password for the Wi-Fi network was entered incorrectly.</b> <ul style="list-style-type: none"> <li>• Delete your home Wi-Fi network and begin the connection process again.</li> </ul>
	<b>Mobile data for your smartphone is turned on.</b> <ul style="list-style-type: none"> <li>• Turn off the Mobile data on your smartphone before connecting the appliance.</li> </ul>
	<b>The wireless network name (SSID) is set incorrectly.</b> <ul style="list-style-type: none"> <li>• The wireless network name (SSID) should be a combination of English letters and numbers. (Do not use special characters.)</li> </ul>
	<b>The router frequency is not 2.4 GHz.</b> <ul style="list-style-type: none"> <li>• Only a 2.4 GHz router frequency is supported. Set the wireless router to 2.4 GHz and connect the appliance to the wireless router. To check the router frequency, check with your Internet service provider or the router manufacturer.</li> </ul>
	<b>The appliance and the router are too far apart.</b> <ul style="list-style-type: none"> <li>• If the appliance is too far from the router, the signal may be weak and the connection may not be configured correctly. Move the router closer to the appliance or purchase and install a Wi-Fi repeater.</li> </ul>
	<b>During Wi-Fi setup, the app is requesting a password to connect to the product (on certain phones).</b> <ul style="list-style-type: none"> <li>• Locate the network name which starts with "LG" under Settings &gt; Networks. Note the last part of the network name. <ul style="list-style-type: none"> <li>- If the network name looks like LGE_Appliance_XX-XX-XX, enter lge12345.</li> <li>- If the network name looks like LGE_Appliance_XXXX, enter XXXX twice as your password. For example, if the network name appears as LGE_Appliance_8b92, then you would enter 8b928b92 as your password. In this instance, the password is case sensitive and the last 4 characters are unique to your appliance.</li> </ul> </li> </ul>

# LIMITED WARRANTY

## USA

### TERMS AND CONDITIONS

**ARBITRATION NOTICE: THIS LIMITED WARRANTY CONTAINS AN ARBITRATION PROVISION THAT REQUIRES YOU AND LG ELECTRONICS (“LG”) TO RESOLVE DISPUTES BY BINDING ARBITRATION INSTEAD OF IN COURT, UNLESS YOU CHOOSE TO OPT OUT. IN ARBITRATION, CLASS ACTIONS AND JURY TRIALS ARE NOT PERMITTED. PLEASE SEE THE SECTION TITLED “PROCEDURE FOR RESOLVING DISPUTES” BELOW.**

Should your LG **Electric Oven** (“Product”) fail due to a defect in materials or workmanship under normal and proper use, during the warranty period set forth below, LG will, at its option, repair or replace the Product. This limited warranty is valid only to the original retail purchaser of the Product (“You”) and applies only when purchased lawfully and used within the United States including U.S. Territories.

Warranty Period	Scope of Warranty	HOW SERVICE IS HANDLED
One (1) year from the date of original retail purchase	Parts and Labor (internal / functional parts only)	LG will provide, free of charge, all labor and in-home service to replace defective part(s).

- Replacement Products and parts are warranted for the remaining portion of the original warranty period or ninety (90) days, whichever is greater.
- Replacement Products and parts may be new, reconditioned, refurbished, or otherwise factory remanufactured.
- Replaced Product or part(s) will be the property of LG.
- Proof of original retail purchase specifying the Product model and date of purchase is required to obtain warranty service under this limited warranty.

**EXCEPT TO THE EXTENT PROHIBITED BY APPLICABLE LAW, ANY IMPLIED WARRANTY OF MERCHANTABILITY OR FITNESS FOR A PARTICULAR PURPOSE ON THE PRODUCT IS LIMITED IN DURATION TO THE DURATION OF THE ABOVE LIMITED WARRANTY. UNDER NO CIRCUMSTANCES SHALL LG OR ITS U.S. DISTRIBUTORS/DEALERS BE LIABLE FOR ANY INDIRECT, INCIDENTAL, CONSEQUENTIAL, SPECIAL, OR PUNITIVE DAMAGES, INCLUDING, WITHOUT LIMITATION, LOST GOODWILL, LOST REVENUES OR PROFITS, WORK STOPPAGE, IMPAIRMENT OF OTHER GOODS, COST OF REMOVAL AND REINSTALLATION OF THE PRODUCT, LOSS OF USE, OR ANY OTHER DAMAGES WHETHER BASED IN CONTRACT, TORT, OR OTHERWISE. LG’S TOTAL LIABILITY, IF ANY, SHALL NOT EXCEED THE PURCHASE PRICE PAID BY YOU FOR THE PRODUCT.**

**SOME STATES DO NOT ALLOW THE EXCLUSION OR LIMITATION OF INCIDENTAL OR CONSEQUENTIAL DAMAGES OR LIMITATIONS ON HOW LONG AN IMPLIED WARRANTY LASTS, SO THE ABOVE EXCLUSIONS OR LIMITATIONS MAY NOT APPLY TO YOU. THIS LIMITED WARRANTY GIVES YOU SPECIFIC LEGAL RIGHTS AND YOU MAY ALSO HAVE OTHER RIGHTS THAT VARY FROM STATE TO STATE.**

### THIS LIMITED WARRANTY DOES NOT COVER

- Service trips to deliver, pick up, or install, educate how to operate, correct wiring, or correct unauthorized repairs.
- Damage or failure of the Product to perform during power failures and interrupted or inadequate electrical service.
- Damage or failure of the Product caused by leaky or broken water pipes, frozen water pipes, restricted drain lines, inadequate or interrupted water supply or inadequate supply of air.
- Damage or failure of the Product resulting from operating the Product in a corrosive atmosphere or contrary to the Product owner’s manual.

- Damage or failure of the Product caused by accidents, pests and vermin, lightning, wind, fire, floods, acts of nature, or any other causes beyond the control of LG.
- Damage or failure of the Product caused by unauthorized modification or alteration, or if the Product is used for other than the intended purpose, or any water leakage where the Product was not properly installed.
- Damage or failure of the Product caused by incorrect electrical current, voltage, or plumbing codes.
- Damage or failure of the Product caused by transportation, storage, and/or handling, including scratches, dents, chips, and/or other damage to the finish of the Product, unless such damage is reported within one (1) week of delivery.
- Damage or failure of the Product resulting from misuse, abuse, improper installation, repair, or maintenance. Improper repair includes the use of parts not authorized by LG. Improper installation or maintenance includes installation or maintenance contrary to the Product owner's manual.
- Damage or failure of the Product caused by the use of parts, components, accessories, consumable cleaning products, or any other products or services that were not authorized by LG.
- Damage or missing items to any display or open box Product.
- Refurbished Product or any Product sold "As Is", "Where Is", "With all Faults", or similar disclaimer.
- Products with original serial numbers that have been removed, altered, or cannot be readily determined.
- Increases in utility costs and additional utility expenses.
- Any noises associated with normal operation.
- Products used for other than normal and proper household use (e.g., commercial or industrial use) or contrary to the Product owner's manual.
- Costs associated with removal and reinstallation of the Product for repairs, or the removal and reinstallation of the Product if it is installed in an inaccessible location or not installed in accordance with the Product Owner's manual.
- Accessories, removable components, or consumable parts (e.g. Shelves, door bins, drawers, water/air filters, racks, light bulbs, batteries, etc., as applicable), except for internal/functional parts covered under this limited warranty.

**The cost of repair or replacement under these excluded circumstances shall be borne by You.**

TO OBTAIN WARRANTY SERVICE AND ADDITIONAL INFORMATION

Call 1-800-243-0000 and select the appropriate option from the menu.

Or visit our website at <http://www.lg.com>

Or by mail: LG Electronics Customer Service P.O. Box 240007 Huntsville, AL 35813 ATTN: CIC

## PROCEDURE FOR RESOLVING DISPUTES

ALL DISPUTES BETWEEN YOU AND LG ARISING OUT OF OR RELATING IN ANY WAY TO THIS LIMITED WARRANTY OR THE PRODUCT SHALL BE RESOLVED EXCLUSIVELY THROUGH BINDING ARBITRATION, AND NOT IN A COURT OF GENERAL JURISDICTION. BINDING ARBITRATION MEANS THAT YOU AND LG ARE EACH WAIVING THE RIGHT TO A JURY TRIAL AND TO BRING OR PARTICIPATE IN A CLASS ACTION.

**Definitions.** For the purposes of this section, references to "LG" mean LG Electronics U.S.A., Inc., its parents, subsidiaries and affiliates, and each of their officers, directors, employees, agents, beneficiaries, predecessors in interest, successors, assigns and suppliers; references to "dispute" or "claim" shall include any dispute, claim or controversy of any kind whatsoever (whether based in contract, tort, statute, regulation, ordinance, fraud, misrepresentation or any other legal or equitable theory) arising out of or relating in any way to the sale, condition or performance of the product or this Limited Warranty.

**Notice of Dispute.** In the event you intend to commence an arbitration proceeding, you must first notify LG in writing at least 30 days in advance of initiating the arbitration by sending a letter to LG at LG Electronics, USA, Inc. Attn: Legal Department- Arbitration 111 Sylvan Avenue, Englewood Cliffs, NJ 07632 USA. You and LG agree to engage in good faith discussions in an attempt to amicably resolve your claim. The notice must provide your name, address, and telephone number; identify the product that is the

subject of the claim; and describe the nature of the claim and the relief being sought. If you and LG are unable to resolve the dispute within 30 days, either party may proceed to file a claim for arbitration.

**Agreement to Binding Arbitration and Class Action Waiver.** Upon failure to resolve the dispute during the 30 day period after sending written notice to LG, you and LG agree to resolve any claims between us only by binding arbitration on an individual basis, unless you opt out as provided below. Any dispute between you and LG shall not be combined or consolidated with a dispute involving any other person's or entity's product or claim. More specifically, without limitation of the foregoing, any dispute between you and LG shall not under any circumstances proceed as part of a class or representative action. Instead of arbitration, either party may bring an individual action in small claims court, but that small claims court action may not be brought on a class or representative basis.

**Arbitration Rules and Procedures.** To begin arbitration of a claim, either you or LG must make a written demand for arbitration. The arbitration will be administered by the American Arbitration Association ("AAA") and will be conducted before a single arbitrator under the AAA's Consumer Arbitration Rules that are in effect at the time the arbitration is initiated (referred to as the "AAA Rules") and under the procedures set forth in this section. The AAA Rules are available online at [www.adr.org/consumer](http://www.adr.org/consumer). Send a copy of your written demand for arbitration, as well as a copy of this provision, to the AAA in the manner described in the AAA Rules. You must also send a copy of your written demand to LG at LG Electronics, USA, Inc. Attn: Legal Department- Arbitration 111 Sylvan Avenue, Englewood Cliffs, NJ 07632 USA. If there is a conflict between the AAA Rules and the rules set forth in this section, the rules set forth in this section will govern. This arbitration provision is governed by the Federal Arbitration Act. Judgment may be entered on the arbitrator's award in any court of competent jurisdiction. All issues are for the arbitrator to decide, except that issues relating to the scope and enforceability of the arbitration provision and to the arbitrability of the dispute are for the court to decide. The arbitrator is bound by the terms of this provision.

**Governing Law.** The law of the state of your residence shall govern this Limited Warranty and any disputes between us except to the extent that such law is preempted by or inconsistent with applicable federal law.

**Fees/Costs.** You do not need to pay any fee to begin an arbitration. Upon receipt of your written demand for arbitration, LG will promptly pay all arbitration filing fees to the AAA unless you seek more than \$25,000 in damages, in which case the payment of these fees will be governed by the AAA Rules. Except as otherwise provided for herein, LG will pay all AAA filing, administration and arbitrator fees for any arbitration initiated in accordance with the AAA Rules and this arbitration provision. If you prevail in the arbitration, LG will pay your attorneys' fees and expenses as long as they are reasonable, by considering factors including, but not limited to, the purchase amount and claim amount. Notwithstanding the foregoing, if applicable law allows for an award of reasonable attorneys' fees and expenses, an arbitrator can award them to the same extent that a court would. If the arbitrator finds either the substance of your claim or the relief sought in the demand is frivolous or brought for an improper purpose (as measured by the standards set forth in Federal Rule of Civil Procedure 11(b)), then the payment of all arbitration fees will be governed by the AAA Rules. In such a situation, you agree to reimburse LG for all monies previously disbursed by it that are otherwise your obligation to pay under the AAA Rules. Except as otherwise provided for, LG waives any rights it may have to seek attorneys' fees and expenses from you if LG prevails in the arbitration.

**Hearings and Location.** If your claim is for \$25,000 or less, you may choose to have the arbitration conducted solely on the basis of (1) documents submitted to the arbitrator, (2) through a telephonic hearing, or (3) by an in-person hearing as established by the AAA Rules. If your claim exceeds \$25,000, the right to a hearing will be determined by the AAA Rules. Any in-person arbitration hearings will be held at a location within the federal judicial district in which you reside unless we both agree to another location or we agree to a telephonic arbitration.

**Opt Out.** You may opt out of this dispute resolution procedure. If you opt out, neither you nor LG can require the other to participate in an arbitration proceeding. To opt out, you must send notice to LG no later than 30 calendar days from the date of the first consumer purchaser's purchase of the product by either: (i) sending an e-mail to [optout@lge.com](mailto:optout@lge.com), with the subject line: "Arbitration Opt Out" or (ii) calling 1-800-980-2973. You must include in the opt out e-mail or provide by telephone: (a) your name and address; (b) the date on which the product was purchased; (c) the product model name or model number; and (d) the serial number (the serial number can be found (i) on the product; or (ii) online by accessing <https://www.lg.com/us/support/repair-service/schedule-repair-continued> and clicking on "Find My Model & Serial Number").

## 48 LIMITED WARRANTY

---

You may only opt out of the dispute resolution procedure in the manner described above (that is, by e-mail or telephone); no other form of notice will be effective to opt out of this dispute resolution procedure. Opting out of this dispute resolution procedure will not affect the coverage of the Limited Warranty in any way, and you will continue to enjoy the full benefits of the Limited Warranty. If you keep this product and do not opt out, then you accept all terms and conditions of the arbitration provision described above.











**LG**

Life's Good

LG Customer Information Center

For inquiries or comments,  
visit **www.lg.com** or call:

**1-800-243-0000** U.S.A.

**1-888-542-2623** CANADA

Register your product Online!

**www.lg.com**