

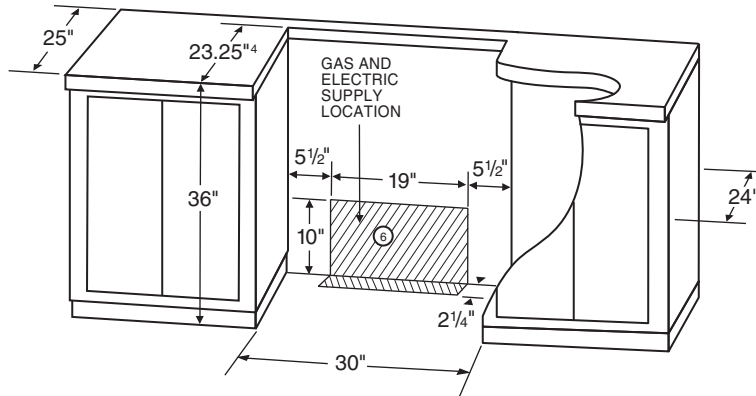

30" SLIDE-IN GAS RANGE

PRODUCT DIMENSIONS



	INCHES	CENTIMETERS
A ¹	26 5/16	66.8
B	30	76.2
C ²	36	91.4

MODEL SKU_s

MGS5875BDW
MGS5875BDB
MGS5875BDQ
MGS5875BDS

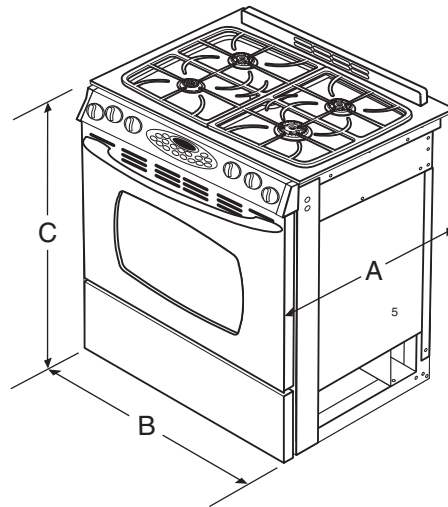

Style of product may vary from picture

NOTES:

1. Depth excluding handle. Dimension given is from wall to front of oven door.
2. Height may vary slightly depending upon leveling legs.
3. If cabinet backsplash behind unit is not present, backsplash kit (UXA9107AA in B=black, W= white, Q= bisque, S=stainless) may be ordered from dealer.
4. When replacing an existing unit, a maximum of 23 1/2" is acceptable. If the cut depth exceeds 23 1/2" use filler kit (K71FILL in B=black, W= white, Q=bisque).
5. If end cabinet is not present, side panel kit (UXA1100AA in B=black, Q=bisque, W=white, S=stainless) may be ordered from dealer.
6. 120 Volt Grounded Electrical Outlet in the hatched area. Outlet MUST be flush. Nothing located in hatched area can extend more than 2" from wall or range will not slide all the way back.
7. Some white European style cabinets are equipped with delicate white vinyl drawer and door fronts. The vinyl may not be designed to withstand the heat produced by the normal safe operation of a selfclean range. Discoloration or delamination may occur. To avoid possible damage, we recommend increasing the 30" cabinet opening to 31 1/4" minimum and using heat shield (CABKIT V). The countertop cut-out must remain 30". Gas lines MUST be installed within the dark shaded and hatched area to ensure proper alignment of this oven with your cabinets. It is recommended to have gas and electric supplies 6" apart.

Important: Because of continuing product improvements, Maytag® reserves the right to change specifications without notice. Dimensional specifications are provided for planning purposes only. For complete details see installation instructions that accompany each product before selecting cabinetry, making cutouts or beginning installation.