

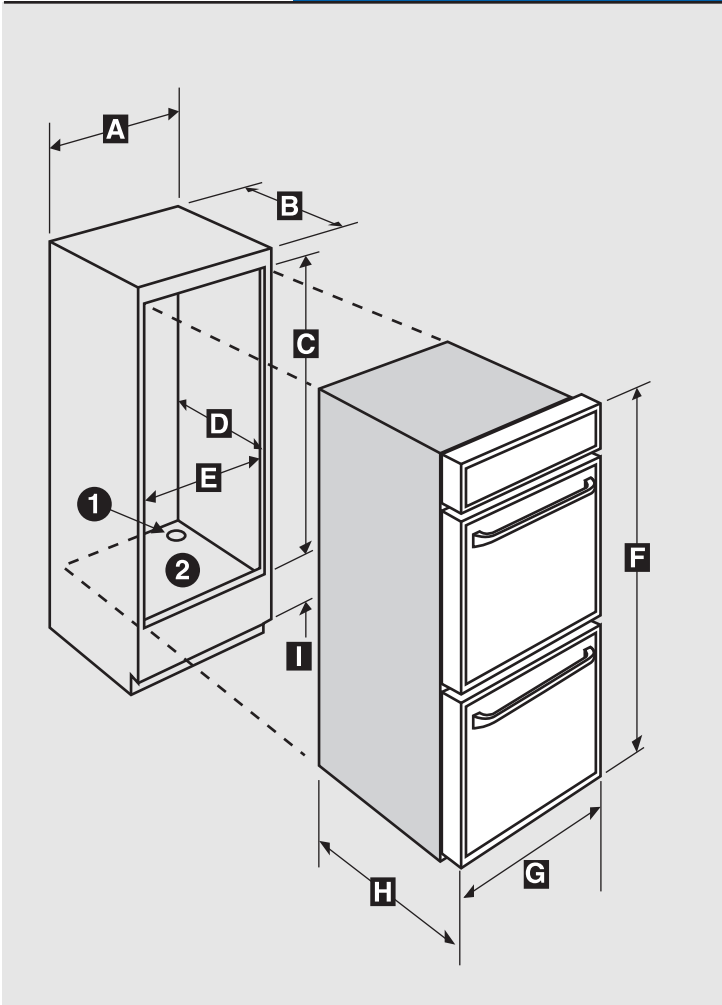

30"

# DOUBLE ELECTRIC WALL OVEN



## Dimensions

■	Inches	Centimeters
A	30 minimum	76.2 minimum
B	24 minimum	61.0 minimum
C	50.0 ± 1/16	127.0
D	24	61.0
E	28 1/2 ± 1/16	72.4
F	50 1/4	127.6
G	29 3/4	75.6
H	24 7/16	62.1
I	4 - 12	10.2 - 30.5

**Notes:**

1. □ 1 1/4" Dia. Conduit Access Hole.
2. □ 5/8" plywood floor (must support 250 lbs.).

Important: Because of continuing product improvements, Maytag reserves the right to change specifications without notice. Dimensional specifications are provided for planning purposes only. For complete details see installation instructions that accompany each product before selecting cabinetry, making cutouts or beginning installation.