

MONOGRAM 36" PREMIUM FULLY INTEGRATED SINGLE DOOR BOTTOM FREEZER (RIGHT-HAND SWING)

ZIC363IPVRH



BOTTOM FREEZER WITH FLUSH INSTALLATION

Concealed hinge offers a look of seamless perfection that installs flush with surrounding cabinetry

6-TEMPERATURE SETTING CONVERTIBLE DRAWER

The convertible drawer with 6 temperature settings allows you to choose temperatures best suited for storing cold drinks, meat, snacks, ice cream, produce or frozen items

STATEMENT AND MINIMALIST COLLECTION REFRIGERATOR HANDLES (SOLD SEPARATELY)

Designed to enhance choice and customization, Statement and Minimalist Collection refrigerators do not come with handles, these must be chosen separately and ordered through a Monogram representative

PANEL-READY EXTERIOR WITH SIX-WAY ADJUSTABILITY

Statement and Minimalist Collection refrigerators accept stainless steel panels, which can be ordered separately from Monogram or your cabinet maker

LED LIGHTING INSIDE REFRIGERATOR

Ramp-up LED interior lighting provides exceptional illumination throughout the fresh food compartment, accentuating the sophisticated interior and allowing you to easily see food in the refrigerator

REFRIGERATOR WITH INTERNAL WATER DISPENSER

The water dispenser on the inside of the refrigerator leaves the outside looking clean and uncluttered

REFRIGERATOR AIR FILTRATION ODOR REDUCING SYSTEM

The refrigerator deodorizer air filtration system helps keep your refrigerator fresh by scrubbing the air of food odors and gases

WIFI CONNECTED REFRIGERATOR

The WiFi refrigerator allows you to wirelessly control refrigerator settings from your smartphone, using an available app

REFRIGERATOR WITH RAMP-UP LED INTERIOR SHELVES

LED-lighted refrigerator shelves provide exceptional illumination throughout the refrigerator compartment, accentuating the sophisticated interior and making contents easy to see

REFRIGERATOR WITH ADJUSTABLE DOOR BINS

Finely crafted, adjustable aluminum door bins with glass accents offer easy access to beverages and quick-grab items

ACCURATE, ELECTRONIC TOUCH CONTROLS

Upfront, electronic touch controls make it easy to adjust climate settings to create ideal food storage conditions

REFRIGERATOR WITH SOFT-CLOSE DRAWERS

The innovative sliding mechanism helps the drawers close gently and completely

HUMIDITY-CONTROLLED VEGETABLE AND FRUIT DRAWER

Enjoy additional storage flexibility that helps to preserve food freshness

FACTORY INSTALLED ICE MAKER

The water filtration system in the factory installed ice maker supplies you with clean, fresh-tasting water and ice

SABBATH MODE REFRIGERATOR

This refrigerator with Sabbath mode is designed to disable functions in accordance with Sabbath-observing practices



SPECIFICATIONS

Overall Width	35 3/4" (90.8 cm)
Overall Height	83 7/8" (213 cm)
Overall Depth	24 3/4" (62.9 cm)
Door Clearance at 90°	see TOP VIEW **Dim A
Cutout Width	36" (91.4 cm)
Cutout Height	84" (213.4 cm)
Cutout Depth	25" (63.5 cm)
Net Weight (approx)	550 lbs (250 kg)

ATTENTION ELECTRICIAN:

A 115 volt 60Hz., 15 or 20 amp power supply is required. An individual properly grounded branch circuit or circuit breaker is recommended. For multiple unit installation, each unit requires separate individually properly grounded circuit or breaker and separate properly grounded 3-prong electrical receptacle recessed.

⚠ WARNING:

When installing appliance, you must use and follow the product installation instructions. These can be found with unit or on web at monogram.com.

OVERALL DIMENSIONS

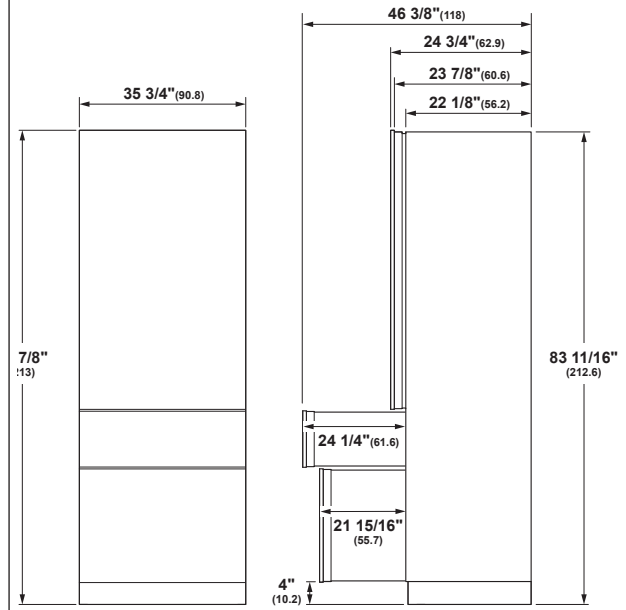

FRONT VIEW

SIDE VIEW

** Includes 3/4" door panel

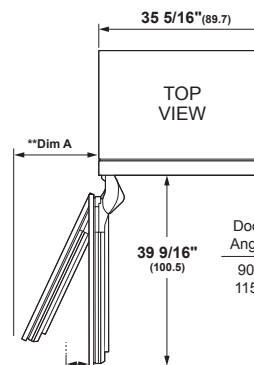

Door Angle	Dim A		Hand Clearance
	Door	Handle	
90°	2 3/16" (5.6)	4 3/4" (12.1)	6 3/4" (17.1)
115°	17 11/16" (44.9)	19 9/16" (49.7)	21 9/16" (54.8)

** Allow 4 9/16" (11.6) min clearance to a adjacent wall from cutout

** Dimensions based on handle height of 2 9/16" (6.5)

Dimensions in parentheses are in centimeters unless otherwise noted. Actual product dimensions may vary due to manufacturing tolerances.

SINGLE INSTALLATION

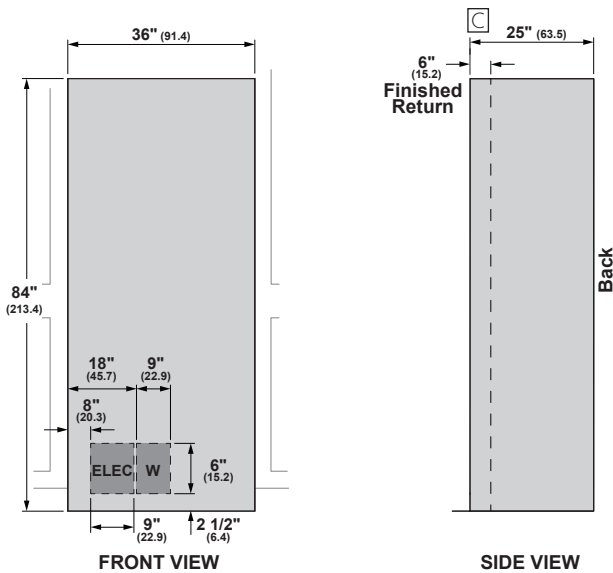

FLUSH 3/4" PANEL DIMENSIONS SINGLE INSTALLATION

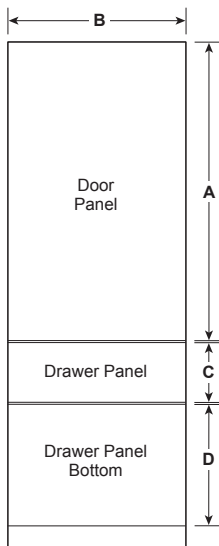

PANEL DIMENSIONS

A	B	C	D
49 3/8"	35 3/4"	9 11/16"	20 5/8"

INTEGRATED INSTALLATION

HELPFUL TIPS

- ☐ A minimum 6" (15.2) finished return matching cabinet exterior recommended on interior on all sides and top at front of opening

Trimmed refrigerators are designed to be customized with decorative panels. Field-installed 3/4" custom door panels are required.

Maximum total panel weight:

- Fresh Food Door - 39.1 lbs
- Convertible Drawer - 7.5 lbs
- Freezer Drawer - 17.1 lbs

For Custom Panels: Use templates provided with units to pre-drill holes for mounting panel brackets (provided with unit). Adjustment screws and instructions also provided with units.

Custom Panels require a custom handle from cabinet maker or the ZKPN - Handle Mounting Kit, is required when using Statement and Minimalist handles (sold separately).

Stainless steel handle and panel options:

- ZK3SN364VRH: Right-hand Single Door Bottom Freezer
- Stainless Steel door panel kit
- ZKSB3H3CVSS: Minimalist handle kit
- ZKSB3H3PVSS: Statement handle kit

GE SmartConnect™ Refrigerator Tubing Kits:

The only Monogram approved plastic tubing is supplied in the SmartConnect Refrigerator Tubing kits.

- WX08X10006: Water Line 8' (2.5m)
- WX08X10015: Water Line 15' (4.6m)
- WX08X10025: Water Line 25' (7.6m)

⚠ WARNING:

When installing appliance, you must use and follow the product installation instructions. These can be found with unit or on web at monogram.com.

This document is intended for cabinet and panel construction only.

DUAL INSTALLATION

36" INTEGRATED BOTTOM FREEZER (LEFT-HAND SWING), ZIC363IPVLH
 36" INTEGRATED BOTTOM FREEZER (RIGHT-HAND SWING), ZIC363IPVRH

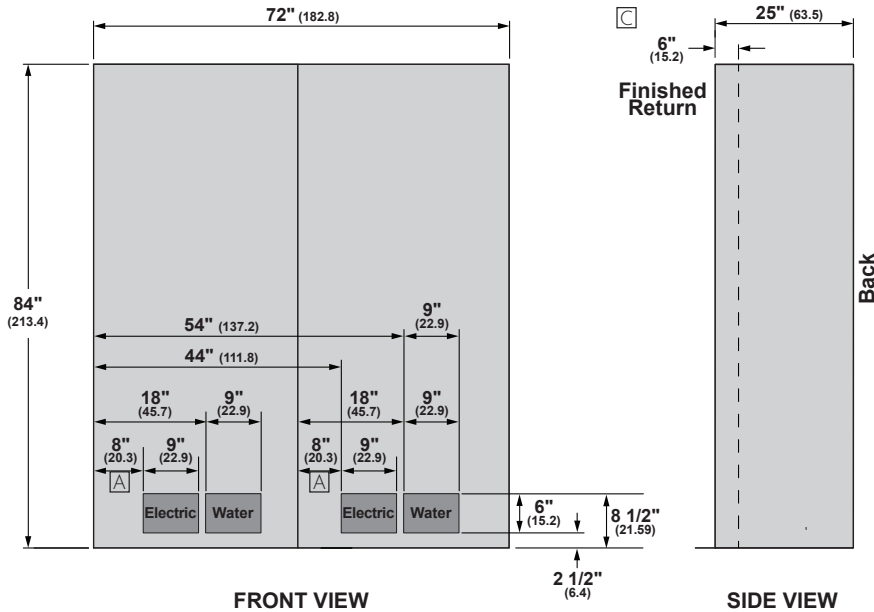

INTEGRATED INSTALLATION

HELPFUL TIPS

- A** A separate 115V, 60Hz, 15- or 20-amp power supply is recommended for each product.
- B** Cutout based on installation of two products with a left-and-right-hand door swing.
- C** A minimum 6" (15.2) finished return matching cabinet exterior recommended on interior on all sides and top at front of opening.
- D** ZKMV Unification Kit is required for Side-by-Side Heater/Dual Installation. Kit generates the 15/16" between units and overall cut out width includes this dimension.

DUAL PRODUCT CLEARANCES

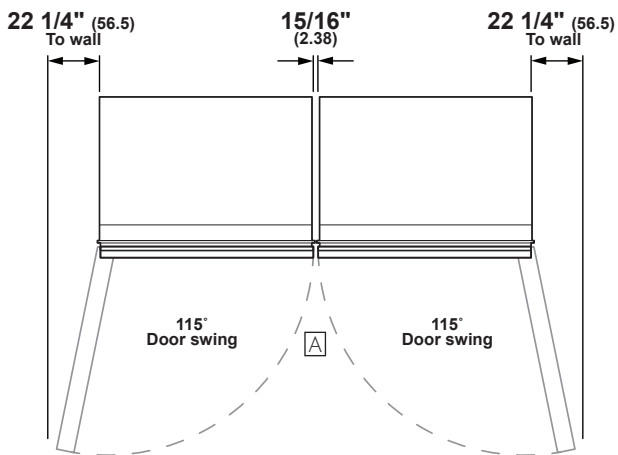

** Dimensions based on handle height of 2 9/16" (6.5)

INTEGRATED INSTALLATION

HELPFUL TIPS

- A** In a side-by-side installation of a left-and-right-hand door swing product, 15/16" clearance between the units is required. Also required is Side-by-Side Heater/Dual Installation Kit, ZKMV.

FLUSH 3/4" PANEL DIMENSIONS DUAL INSTALLATION

36" BOTTOM FREEZER (LEFT-HAND SWING), ZIC363IPVLH
 36" BOTTOM FREEZER (RIGHT-HAND SWING), ZIC363IPVRH

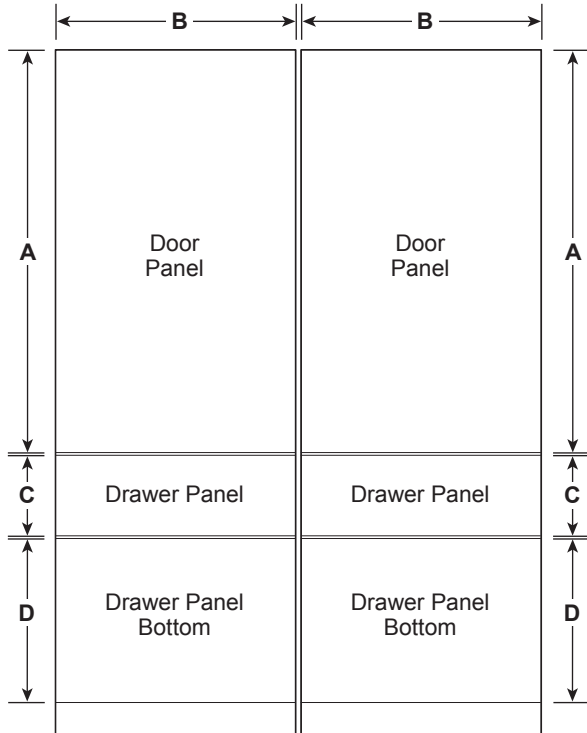

PANEL DIMENSIONS

A	B	C	D
49 3/8"	35 13/16"	9 11/16"	20 5/8"

**INTEGRATED
 INSTALLATION
 HELPFUL TIPS**

Trimmed refrigerators are designed to be customized with decorative panels. Field-installed 3/4" custom door panels are required.

Maximum total panel weight:
 Fresh Food Door - 39.1 lbs
 Convertible Drawer - 7.5 lbs
 Freezer Drawer - 17.1 lbs

Note: For panels constructed with rails and stiles (5-panel), the rails and stiles must be a minimum of 2" wide.

For Custom Panels: Use templates provided with units to pre-drill holes for mounting panel brackets (provided with unit). Adjustment screws and instructions also provided with units.

Custom Panels require a custom handle from cabinet maker or the ZKPN - Handle Mounting Kit, is required when using Statement and Minimalist handles (sold separately).

Stainless steel handle and panel options:
 ZK3SN364VRH: Right-hand single door bottom freezer stainless steel door panel kit
 ZK3SN369VLH: Left-hand single door bottom freezer stainless steel door panel kit
 ZKSB3H3CVSS: Minimalist handle kit
 ZKSB3H3PVSS: Statement handle kit

Dual installation accessory kits:
 ZKN72V: 72" stainless full-width toekick
 ZKMV: Integrated bottom-freezer unification/heater kit