

MONOGRAM 36" BUILT-IN FRENCH-DOOR REFRIGERATOR ZIPS360NNSS



When ordering this product,
be sure to use the model number
associated with the chosen handle.



Statement handle
ZKSB2H2PNSS



Minimalist handle
ZKSB2H2CNSS

STATEMENT HANDLE

Model is shown with the Statement handle, which needs to be ordered separately. To order this handle use model number ZKSB2H2PNSS.

MINIMALIST HANDLE

Model is shown with the Minimalist handle, which needs to be ordered separately. To order this handle use model number ZKSB2H2CNSS.

FRENCH-DOOR DESIGN

Gives you wide-open access to every fresh food shelf and bin

FINELY CRAFTED GLASS-FRONT METAL DOOR BINS

With riveted metal accents offer easy access to beverages and quick-grab items

LED LIGHTING

Positioned throughout the interior and under fresh food drawers spotlights food inside the refrigerator and in the freezer

UPFRONT ELECTRONIC CONTROLS WITH DIGITAL READOUT

Offer a range of precise temperature settings, all within easy reach

LARGE FULL-EXTENSION FREEZER DRAWER

Has storage bins that slide out independently of one another for easy loading and unloading. An automatic icemaker keeps plenty of filtered ice on hand

PRECISION GLASS-FRONT PRODUCE AND DELI DRAWERS

Feature full-extension, soft-close slides

ALUMINUM TRIMMED GLASS SHELVES

Allow convenient access to contents in the fresh-food compartment



SPECIFICATIONS

Overall Width	36" (91.4 cm)
Overall Height	84" (213.4 cm)
Overall Depth	25 15/16" (65.9 cm)
Door Clearance	18 1/2" (47cm)
Cutout Width	35 1/2" (90.2 cm)
Cutout Height	83 1/2" - 84 1/2" (212.1-214.6 cm)
Cutout Depth	24" (61 cm)
Plumbing Requirements	1/4" OD copper tubing or GE SmartConnect kit
Shipping Weight	715 lb (324 kg)

ATTENTION ELECTRICIAN:

A 115 volt 60Hz., 15 or 20 amp power supply is required. An individual properly grounded branch circuit or circuit breaker is recommended. Install a properly grounded 3-prong electrical receptacle recessed into the back wall.

OVERALL DIMENSIONS

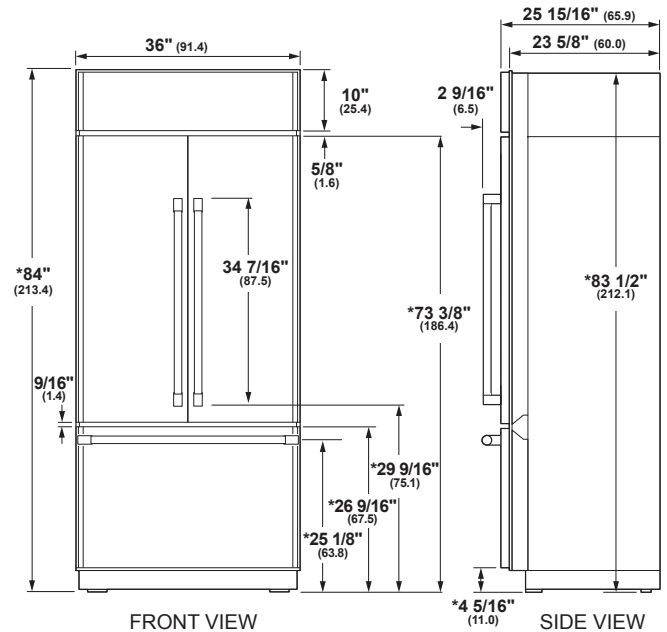

*Shipping height. Use leveling legs and wheels for maximum 1" height adjustment from shipping height.

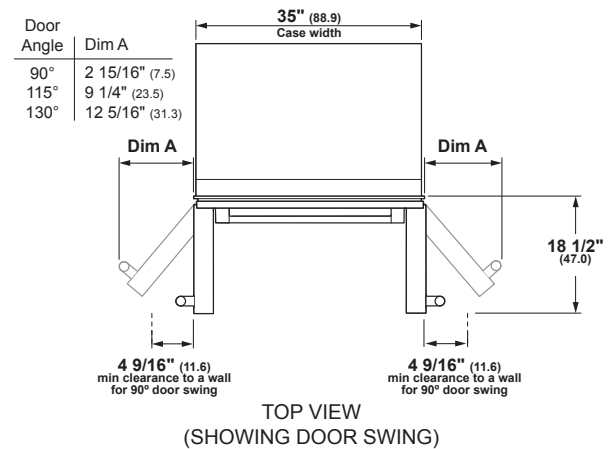

Dimensions in parentheses are in centimeters unless otherwise noted. Actual product dimensions may vary due to manufacturing tolerances.

DUAL INSTALLATIONS

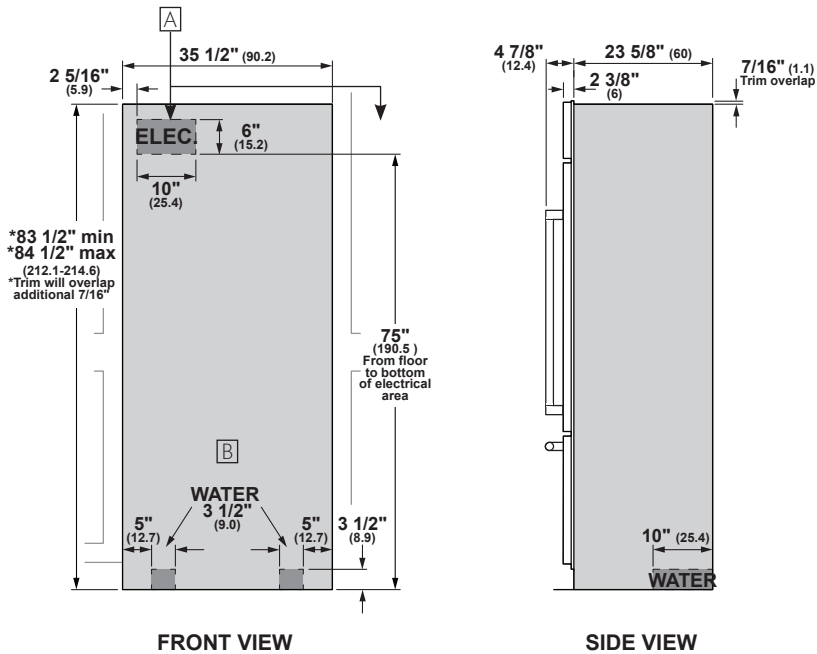

ANTI-TIP BRACKET

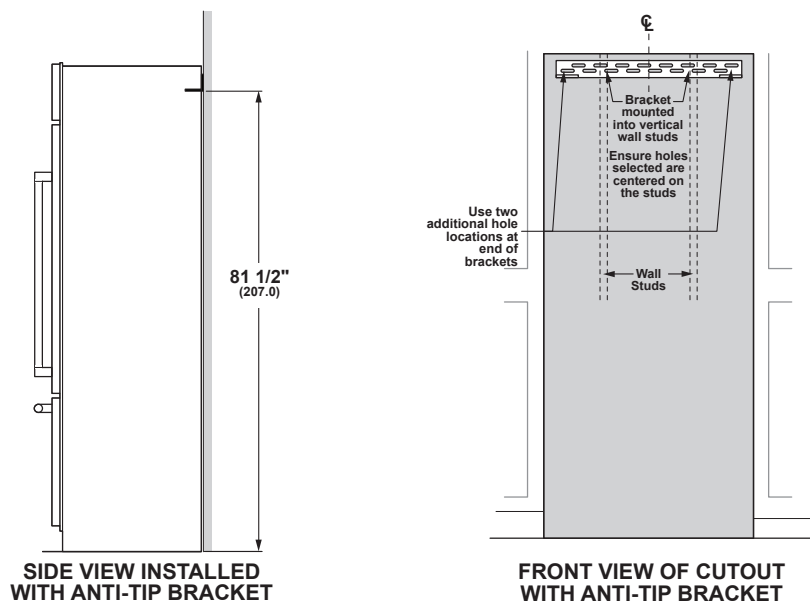

HELPFUL TIPS

A Mounting the junction box in this location will also allow for front accessibility through access panel.

B Water supply area

⚠ WARNING:

The refrigerator is top heavy and must be secured to prevent the possibility of tipping forward. Failure to do so may result in death or serious injury.

The information below is for cabinet design only. When installing the anti-tip system you must use the product installation instructions.

The information below applies to all installation constructions:

- A wall bracket, bolts and toggles will be supplied with the unit.
- The bolts will be used to attach bracket to wall in 4 locations. Two of the locations must penetrate the center of the wall studs.
- The toggles are used for stability in drywall and when metal studs are encountered. Lag bolts are used in wood studs.
- In installation opening, measure 81-1/2" from floor and draw a horizontal line.
- Locate and mark the wall studs on horizontal line. Verify at least two studs have their centerlines within the center 32-1/2" of installation opening to ensure 2 wall studs are penetrated.
- The bracket will be centered left to right in opening with bottom of bracket on the horizontal line.
- When unit is placed in opening, the bracket tabs will align with openings in back of the unit. The unit will be secured to the bracket using supplied "L" bolts.

See Installation Instructions for detailed instructions.