

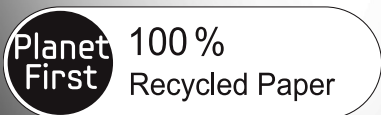

NE597N0PBSR

Electric Range user manual



This manual is made with 100 % recycled paper.

imagine the possibilities

ENGLISH

Thank you for purchasing this Samsung product.
To receive more complete service, please register
your product at

www.samsung.com/register

1-800-SAMSUNG (726-7864)



important safety instructions











Read and follow all instructions before using your oven to prevent the risk of fire, electric shock, personal injury, or damage when using the range. This guide does not cover all possible conditions that may occur. Always contact your service agent or manufacturer about problems that you do not understand.

WHAT YOU NEED TO KNOW ABOUT SAFETY INSTRUCTIONS

Warnings and Important Safety Instructions in this manual do not cover all possible conditions and situations that may occur. It is your responsibility to use common sense, caution, and care when installing, maintaining, and operating your oven.

IMPORTANT SAFETY SYMBOLS AND PRECAUTIONS

What the icons and symbols in this user manual mean:

 WARNING	Hazards or unsafe practices that may result in severe personal injury or death.
 CAUTION	Hazards or unsafe practices that may result in minor personal injury or property damage.
 CAUTION	To reduce the risk of fire, explosion, electric shock, or personal injury when using your oven, follow these basic safety precautions.
	Do NOT attempt.
	Do NOT disassemble.
	Do NOT touch.
	Follow directions explicitly.
	Unplug the power plug from the wall socket.
	Make sure the machine is grounded to prevent electric shock.
	Call the service center for help.
	Note

These warning icons and symbols are here to prevent injury to you and others. Please follow them explicitly.

After reading this section, keep it in a safe place for future reference.

ANTI-TIP DEVICE



WARNING - To reduce the risk of tipping the range, the range must be secured by a properly installed Anti-Tip device. **AFTER THE RANGE HAS BEEN INSTALLED, CONFIRM THAT THE ANTI-TIP DEVICE HAS BEEN PROPERLY INSTALLED AND VERIFY THAT THE ANTI-TIP DEVICE IS PROPERLY ENGAGED.** Refer to the installation manual for instructions.

- a) If the anti-tip device is not installed, a child or adult can tip the range and be killed.
- b) Verify the anti-tip device has been properly installed and engaged at rear right (or rear left) of the range bottom.
- c) If you move the range and then move it back into place, ensure the anti-tip device is re-engaged at the right or left rear of the range bottom.
- d) Do not operate the range without the anti-tip device in place and engaged.
- e) Failure to do so can result in death or serious burns to children or adults.



WARNING

- Do not step, lean, or sit on the doors of the range.** You can cause the range to tip, resulting in burns or serious injuries.
- Confirm that the Anti-Tip device is installed properly. Then, to verify that the Anti-Tip device is engaged, grasp the top rear edge of the range and carefully attempt to tilt it forward. The Anti-Tip device should prevent the range from tilting forward more than a few inches.

If you pull the range out from the wall for any reason, make sure the anti-tip device is properly engaged when you push the range back against the wall. If it is not, there is a possible risk of the range tipping over and causing injury if you or a child stand, sit or lean on an open door.

FOR YOUR SAFETY

When using electrical appliances, you should follow basic safety precautions, including the following:





Use this appliance only for its intended purpose as described in this Owner's Manual.

Potentially hot surfaces include the cooktop, areas facing the cooktop, oven vent opening, surfaces near the opening, crevices around the oven door.



Be sure your appliance is properly installed and grounded by a qualified technician.

 **User servicing** - Do not repair or replace any part of the appliance unless specifically recommended in the manual. All other servicing should be referred to a qualified technician.

 Always disconnect the power to the appliance before servicing by removing the fuse or switching off the circuit breaker.

 **Do not enter the oven.**

Do not store items of interest to children in cabinets above a range or on the back guard of a range. Children climbing on the range to reach items could be seriously injured.

Do not leave children alone. Never leave children alone or unattended in an area where this appliance is in use. They should never be allowed to sit or stand on any part of the appliance.

Never use your appliance for warming or heating the room.

Do not use water on grease fires. Turn off the oven to avoid spreading the flame. Smother the fire or flame by closing the door or use a dry chemical, baking soda, or foam-type extinguisher.

The inner portion of the split oven rack (if equipped) could drop down accidentally if not assembled properly. Place the inner rack in the proper position within the outer rack.

 **Storage in or on appliance.** Do not store flammable materials in the oven or near the surface units. Be sure all packing materials are removed from the appliance before operating it. Keep plastics, clothes, and paper away from parts of the appliance that may become hot.

Wear proper apparel. Never wear loose-fitting or hanging garments while using the appliance.

Use only dry potholders. Placing moist or damp potholders on hot surfaces may result in burns from steam. Do not let the potholder touch hot heating elements. Do not use a towel or other bulky cloth.

Teach children not to play with the controls or any other part of the range.

For your safety, do not use high-pressure water cleaners or steam jet cleaners.

If the power cord is damaged, it must be replaced by the manufacturer, its service agent or similarly qualified persons in order to avoid a hazard.

The appliance is not intended for use by persons (including children) with reduced physical, sensory or mental capabilities, or lack of experience and knowledge, unless they have been given supervision or instruction concerning use of the appliance by a person responsible for their safety.



INDUCTION COOKTOP ELEMENTS

- ★ **Be sure you know which touch control operates each surface heating unit.** Place a pan of food on the unit before turning it on, and turn the unit off before removing the pan.

Use proper pan sizes - This appliance is equipped with surface units of different sizes. Select pots and pans that have flat bottoms large enough to cover the surface area of the heating element. Using undersized cookware will expose a portion of the heating element to direct contact and may result in the ignition of clothing. Matching the size of the pot or pan to the burner will also improve efficiency.

Cookware Handles Should Be Turned Inward and Not Extend Over Adjacent Surface Elements - To reduce the risk of burns, ignition of flammable materials, and spillage due to unintentional contact with the cookware, cookware handles should be positioned so that they are turned inward, and do not extend over adjacent surface units.

Glazed Cookware - Only certain types of glass, glass/ceramic, ceramic, earthenware, or other glazed cookware are suitable for range-top service without breaking due to the sudden change in temperature.

Never Leave Surface Elements Unattended at High Heat Settings - Boilovers cause smoking and greasy spillovers that may ignite, or a pan that has boiled dry may melt.

Metallic objects such as knives, forks, spoons and lids should not be placed on the Induction Cooktop surface since they can get hot.

When preparing flaming foods under a ventilating hood, turn the fan on.

Use care when touching the cooktop. The glass surface of the cooktop will retain heat after the controls have been turned off.

Always turn the surface units off before removing cookware.

Keep an eye on foods being fried at high or medium high heat settings.

Be careful when placing spoons or other stirring utensils on the glass cooktop surface when it is in use. They may become hot and could cause burns.

- ☐ **Do not lift the cooktop.** Lifting the cooktop can lead to damage and improper operation of the range.

Never use the glass cooktop surface as a cutting board.

Do not operate the cooktop when there is no cookware.

ELECTRICAL SAFETY

-  **Proper Installation-** Be sure your appliance is properly installed and grounded by a qualified technician.

The appliance should be serviced only by qualified service personnel. Repairs carried out by unqualified individuals may cause injury or a serious malfunction. If your appliance is in need of repair, contact a Samsung authorized service center. Failure to follow these instructions may result in damage and void the warranty.

Flush - mounted appliances may be operated only after they have been installed in cabinets and workplaces that conform to the relevant standards. This ensures sufficient protection against contact for electrical units as required by the essential safety standards.

If your appliance malfunctions or if fractures, cracks or splits appear:

- switch off all cooking zones.
- unplug the range from the AC wall outlet.
- contact your local service center.



WARNING- If the surface is cracked, switch off and unplug the appliance to avoid the possibility of electrical shock. Do not use your Induction cooktop until the glass surface has been replaced.



WARNING- Ensure that the appliance is switched off before replacing the lamp to avoid the possibility of electric shock.

The range should not be placed on a base.

CHILD SAFETY



WARNING- This appliance is not intended for use by young children or infirm persons without the adequate supervision of a responsible adult.

Young children should be supervised to ensure that they do not play with the appliance.

Keep children away from the door when opening or closing it as they may bump themselves on the door or catch their fingers in the door.

The cooking zones will become hot when you cook. Always keep small children away from the appliance.

The inner rack of the Split Rack can be dropped if it is not assembled properly. Place the Inner rack in the proper place on the Outer rack. Always insert the rack or split rack assembly (if equipped) on the same level of the oven cavity side.

During cleaning, the surfaces may get hotter than usual and children should be kept away.



WARNING- Accessible parts may become hot during use. To avoid burns, young children should be kept away.

OVEN



DO NOT TOUCH THE HEATING ELEMENTS OR INTERIOR SURFACES OF THE OVEN.

Heating elements may be hot even though they are dark in color. Interior surfaces of an oven become hot enough to cause burns. During and after use, do not touch or let clothing or other flammable materials contact the heating elements or interior surfaces of the oven until they have had sufficient time to cool. Other surfaces of the appliance may become hot enough to cause burns. Among these surfaces are oven vent openings and surfaces near these openings, oven doors, and windows of oven doors.

Do not heat unopened food containers. Build-up of pressure may cause the container to burst and result in injury.

Do not use the oven to dry newspapers. If overheated, they can catch on fire.

Do not use the oven for a storage area. Items stored in an oven can ignite.

- ★ **Use care when opening the door.** Let hot air or steam escape before you remove food from or put food into the oven.

Protective liners. Do not use aluminum foil to line the oven bottoms, except as suggested in the manual. Improper installation of these liners may result in a risk of electric shock or fire.

Keep oven vent ducts unobstructed. The oven vent is located above the right rear surface unit. This area could become hot during oven use. Never block this vent or place plastic or heat-sensitive items on it.

Placement of oven racks. Always place oven racks in the desired location while the oven is cool. If the rack must be moved while the oven is hot, use potholders. Do not let the potholders come in contact with the hot heating element in the oven.

- ☒ Do not allow aluminum foil or a meat probe to contact the heating elements.

During use, the appliance becomes hot. Care should be taken to avoid touching heating elements inside the oven.

- ☒ Do not use harsh abrasive cleaners or sharp metal scrapers to clean the oven door glass since they can scratch the surface, which may result in the glass shattering.

WARMING DRAWER

- ☒ **DO NOT TOUCH THE HEATING ELEMENT OR THE INTERIOR SURFACE OF THE DRAWER.** These surfaces may be hot enough to burn.

REMEMBER: The inside surface of the drawer may be hot when the drawer is opened.

- ☒ **The purpose of the warming drawer is to hold hot cooked foods at serving temperature.** Always start with hot food; cold food cannot be heated or cooked in the warming drawer.

- ★ **Use care when opening the drawer.** Open the drawer a crack and let hot air or steam escape before removing or replacing food. Hot air or steam which escapes can cause burns to hands, face and/or eyes.



- Do not use the drawer to dry newspapers.** If overheated, they can catch on fire.

Do not use aluminum foil to line the drawer. Foil is an excellent heat insulator and will trap heat beneath it. This will upset the performance of the drawer and it could damage the interior finish.

Do not leave paper products, plastics, canned food or combustible materials in the drawer.

Never leave jars or cans of fat drippings in or near your drawer.

Do not warm food in the drawer for more than three hours.

SELF-CLEANING OVENS

- Do not clean the door gasket.** The door gasket is essential for a good seal. Care should be taken not to rub, damage, or move the gasket.
- Never keep pet birds in the kitchen.** Birds are extremely sensitive to the fumes released during an oven self-clean cycle. Fumes may be harmful or fatal to birds. Move birds to a well-ventilated room.

Clean only the parts listed in this manual in the self-clean cycle. Before self-cleaning the oven, remove the partition, rack, utensils, and food.

Do not use any commercial oven cleaner or oven liner protective coating of any kind in or on the outside of the oven. Use only a ceramic cooktop cleaner.

- Remove the nickel oven shelves from the oven before you begin the self-cleaning cycle, or they may discolor.

If the self-clean mode malfunctions, turn the oven off and disconnect the power supply. Have it serviced by a qualified technician.

Excess spillage must be removed before cleaning.

VENTILATING HOOD

- Clean ventilating hoods frequently.** Do not let grease accumulate on the hood or filter.

When flaming foods under the hood, turn the fan on.

GLASS/CERAMIC COOKING SURFACES



 **DO NOT TOUCH SURFACE UNITS OR AREAS NEAR UNITS.**

Surface units may be hot even though they are dark in color. Areas near surface units may become hot enough to cause burns. During and after use, do not touch, or let clothing or other flammable materials contact the surface units or areas near the units until they have had sufficient time to cool. Among these areas are the cook-top and the facing of the cook-top.

Do not cook on a broken cooktop. If the cooktop should break, cleaning solutions and spillovers may penetrate the broken cook-top and create a risk of electric shock. Contact a qualified technician immediately.

-  **Clean the cooktop with caution.** If a wet sponge or cloth is used to wipe spills on a hot cooking area, be careful to avoid steam burn. Some cleaners can produce noxious fumes if applied to a hot surface.

BEFORE YOU BEGIN

-  **Clean the oven thoroughly before using for the first time.** Remove the accessories and operate the oven at the bake setting of 400 °F for 1 hour before using. There will be a distinctive odor. This is normal. Ensure your kitchen is well ventilated during this conditioning period.



CRITICAL INSTALLATION WARNINGS

-  This appliance must be installed by a qualified technician or service company.
- Failing to have a qualified technician install the range may result in electric shock, fire, an explosion, problems with the product, or injury.

Unpack the oven. remove all packaging material and examine the oven for any damage such as dents on the interior or exterior of the oven, broken door latches, cracks in the door, or a door that is not lined up correctly. If there is any damage, do not operate the oven and notify your dealer immediately.

Plug the power cord into a properly grounded outlet with the proper configuration. Your oven should be the only item connected to this circuit.

Keep all packaging materials out of the reach of children. Children may use them for play and injure themselves.

Install your appliance on a level and hard floor that can support its weight.

- Failing to do so may result in abnormal vibrations, noise, or problems with the product.

 This appliance must be properly grounded.

Do not ground the appliance to a gas pipe, plastic water pipe, or telephone line.

- This may result in electric shock, fire, an explosion, or problems with the product.

Do not cut or remove the ground prong from the power cord under any circumstances.

Connect the oven to a circuit that provides the correct amperage.

 Do not install this appliance in a humid, oily or dusty location, or in a location exposed to direct sunlight or water (rain drops).

- This may result in electric shock or fire.

Do not use a damaged power cord or loose wall socket.

- This may result in electric shock or fire.

Do not pull or excessively bend the power cord.

Do not twist or tie the power cord.

Do not hook the power cord over a metal object, place a heavy object on the power cord, or insert the power cord between objects.

- This may result in electric shock or fire.

 If the power cord is damaged, contact your nearest service center.



CRITICAL USAGE WARNING

 If the appliance is flooded by any liquid, please contact your nearest service center. Failing to do so may result in electric shock or fire.

If the appliance produces a strange noise, a burning smell, or smoke, unplug the power plug immediately and contact your nearest service center.



- Failing to do so may result in electric shock or fire.

In the event of a gas leak (such as propane gas, LP gas, etc.), ventilate the area immediately. Do not touch the power cord. Do not touch the appliance.

- A spark may result in an explosion or fire.

Take care not to contact the oven door, heating elements, or any of the other hot parts with your body while cooking or just after cooking.

- Failing to do so may result in burns.

- 
- 
- 
- If materials inside the oven should ignite, keep the oven door closed, turn the oven off and disconnect the power cord, or shut off power at the fuse or circuit breaker panel. If the door is opened, the fire may spread.

Always observe safety precautions when using your oven. Never try to repair the oven on your own - there is dangerous voltage inside. If the oven needs to be repaired, contact an authorized service center near you.

If you use the appliance when it is contaminated by foreign substances such as food waste, it may result in a problem with the appliance.

Take care when removing the wrapping from food taken out of the appliance.

- If the food is hot, hot steam may be emitted abruptly when you remove the wrapping and this may result in burns.

- Do not attempt to repair, disassemble, or modify the appliance yourself.
 - Since a high voltage current enters the product chassis, it may result in electric shock or fire.
 - When a repair is needed, contact your nearest service center.
- If any foreign substance such as water has entered the appliance, contact your nearest service center.
 - Failing to do so may result in electric shock or fire.

- Do not touch the power cord with wet hands.
 - This may result in electric shock.

Do not turn the appliance off while an operation is in progress.

- This may cause a spark and result in electric shock or fire.

Keep all packaging materials well out of the reach of children, as packaging materials can be dangerous to children.

- If a child places a plastic bag over its head, the child can suffocate.

Do not let children or any person with reduced physical, sensory or mental capabilities use this appliance unsupervised.

Make sure that the appliance's controls and cooking areas are out of the reach of children.

- Failing to do so may result in electric shock, burns or injury.



Do not touch the inside of the appliance immediately after cooking. The inside of the appliance will be hot.

- Failing to do so may result in burns.

Do not use or place flammable sprays or objects near the oven.

- Flammable items or sprays can cause fires or an explosion.



- 
- 
- 
- Do not insert fingers, foreign substances, or metal objects such as pins or needles into inlets, outlets, or holes. If foreign substances are inserted into any of these holes, contact your product provider or nearest service center.

Do not tamper with or make any adjustments or repairs to the door. Under no circumstances should you remove the door or outer shell of the oven.

Do not store or use the oven outdoors.

Never use this appliance for purposes other than cooking.

- Using the appliance for any purpose other than cooking may result in fire.

Open the cap or stopper of sealed containers (herb tonic tea bottle, baby bottle, milk bottle and so on) before heating them. Make a hole in food items that have shells (eggs, chestnuts, etc) with a knife before cooking them.

- Failing to do so may result in burns or injury.

Never heat plastic or paper containers and do not use them for cooking.

- Failing to do so may result in fire.

Do not heat food wrapped in paper from magazines, newspapers, etc.

- This may result in fire.

Do not open the door when the food in the oven is burning.

- If you open the door, it causes an inflow of oxygen and may cause the food to ignite.

Do not apply excessive pressure to the door or the inside of the appliance. Do not strike the door or the inside or the appliance.

- Hanging on to the door may result in the product falling and cause serious injury.
- If the door is damaged, do not use the appliance. Contact a service center.

Do not hold food in your bare hands during or immediately after cooking.

- Use cooking gloves. The food may be very hot and you could burn yourself.



USAGE CAUTIONS

★ If the surface is cracked, turn the appliance off.

- Failing to do so may result in electric shock.

Dishes and containers can become hot. Handle with care.

Hot foods and steam can cause burns. Carefully remove container coverings, directing the steam away from hands and face.

Remove lids from baby food jars before heating. After heating baby food, stir well to distribute the heat evenly. Always test the temperature by tasting before feeding the baby. The glass jar or the surface of the food may appear to be cooler than the interior, which can be hot enough to burn an infant's mouth.

Take care as beverages or food may be very hot after heating.

- Especially when feeding a child. Check that it has cooled sufficiently.

Take care when heating liquids such as water or other beverages.

- Make sure to stir during or after cooking.
- Avoid using a slippery container with a narrow neck.
- Wait at least 30 seconds after heating before removing the heated liquid.
- Failing to do so may result in an abrupt overflow of the contents and cause burns.

□ Do not stand on top of the appliance or place objects (such as laundry, oven cover, lighted candles, lighted cigarettes, dishes, chemicals, metal objects, etc.) on the appliance.

- Items, such as a cloth, may be caught in the door.
- This may result in electric shock, fire, problems with the product, or injury.

Do not operate the appliance with wet hands.

- This may result in electric shock.

Do not spray volatile substances such as insecticide onto the surface of the appliance.

- As well as being harmful to humans, it may also result in electric shock, fire or problems with the product.

Do not put your face or body close to the appliance while cooking or when opening the oven door just after cooking.

- Take care that children do not come too close to the appliance.
- Failing to do so may result in children burning themselves.

Do not place food or heavy objects over the edge of the oven door.

- If you open the door, the food or object may fall and this may result in burns or injury.

Do not abruptly cool the door, the inside of the appliance, or a dish by pouring water over it during or just after cooking.

- This may result in damage to the appliance. The steam or water spray may result in burns or injury.

- ☐ Do not operate while empty except for self-cleaning.

Do not defrost frozen beverages in narrow-necked bottles. The containers can break.

Do not scratch the glass of the oven door with a sharp object.

- This may result in the glass being damaged or broken.

Do not store anything directly on top of the appliance when it is in operation.

Do not use sealed containers. Remove seals and lids before cooking. Sealed containers can explode due to buildup of pressure even after the oven has been turned off.

Take care that food you are cooking in the oven does not come into contact with the heating element.

- This may result in fire.

Do not over-heat food.

- Overheating food may result in fire.



CRITICAL CLEANING WARNINGS

- ☑ Do not clean the appliance by spraying water directly on to it.

Do not use benzene, thinner or alcohol to clean the appliance.

- This may result in discoloration, deformation, damage, electric shock or fire.

Take care not to hurt yourself when cleaning the appliance (external/internal).

- You may hurt yourself on the sharp edges of the appliance.

Do not clean the appliance with a steam cleaner.

- This may result in corrosion.

Keep the inside of the oven clean. Food particles or spattered oils stuck to the oven walls or floor can cause paint damage and reduce the efficiency of the oven.



STATE OF CALIFORNIA PROPOSITION 65 WARNINGS:

WARNING: This product contains chemicals known to the State of California to cause cancer and reproductive toxicity.



features of your new range

Enhanced convenience. Better cooking. Easy maintenance. Your new electric range has been designed to bring you these benefits and more.

- **The latest in heat-distribution technology**

Other ranges with just one fan tend to make a swirl of heat that fails to cover the whole inside of the oven. This means uneven heat distribution and uneven cooking. Your new range has Surround Airvection™, which Samsung enhanced by adding a third heating element and a multi-fan system that circulates the heat evenly in all directions. You get more efficient energy consumption and more even cooking.

- **Steam Quick cleaning**

Thanks to Steam Quick™, Samsung's unique technology for light-duty cleaning jobs, keeping your oven spick-and-span is a snap — no hassle, no odor, no chemicals. Steam Quick™ cleans the inside of your range with high-temperature steam in just 20 minutes.

- **Bigger is better**

With a capacity of 5.9 cubic feet, your new range is equipped with more space than any of its competitors in the U.S. market. This means greater convenience for you when cooking for the holidays or when entertaining.

- **Induction Cooktop Features**

Fast and Efficient - Induction cooking heats faster while using less energy. Induction power levels are quick to boil and efficient when simmering.

A Cooler Cooktop - A unique feature of the Induction Cooktop is, whether ON or OFF, the cooktop surface remains cooler than Radiant ceramic style cooktops. Virtually no wasted heat is produced since induction elements heat only when covered by a pan.

Easy Clean-ups - The cooler cooktop surface (when compared to a Radiant cooktop) makes clean-ups easier. Spills resist sticking or burning so they wipe up easier.

Magnetic Detector - The coil sensor automatically detects whether a pan is magnetic and eliminates any accidental "turn-ons". No need to worry if you accidentally set a plastic or wooden spatula or spoon down on an induction element.

Pan Size Detection - The pan size recognition sensor automatically detects and adapts the Cooking Zones to the pan sizes in use for consistent, more even cooking.

More Responsive - Induction cooktops are more responsive than their electric or gas counterparts because only the pan heats. This type of cooking heats easier and is just as responsive when reduced to a simmer.

Flexcook Zone - Lets you use a giant pan or griddle, which does not fit on a conventional sized heating element, by combining the two left side Induction elements into one.

Boil Alert - After water is boiling, the Boil Alert function automatically reduces power to a power level you have selected and sounds a signal.

 **CAUTION** -The Cooking Zones may appear to be cool while turned ON and after they have been turned OFF. **The ceramic glass surface may be HOT** from residual heat transferred from the cookware and burns may occur.

contents

INTRODUCING YOUR NEW RANGE

18

- 18 Overview
- 18 What's included with your range

INDUCTION COOKTOP COOKING

19

- 19 About induction cooktop cooking
- 20 Location of the induction cooktop elements and controls
- 21 Induction touch control
- 22 Using the touch control pads
- 22 How to set the appliance for cooktop cooking
- 22 Select cooking zone on
- 22 Power setting
- 23 Induction power boost control
- 23 Induction simmer control
- 23 Switching a cooking zone off
- 23 Flexcook zone control
- 25 Boil alert control (only use the largest burner)
- 26 Before using the cooktop
- 28 Cookware for induction cooking zones
- 28 Use the correct size cookware
- 28 Size of pans
- 29 Operating noises
- 29 Using suitable induction cookware
- 30 Temperature detection
- 30 Suggested settings for cooking specific foods
- 31 Protecting the cooktop surface

USING THE WARMING DRAWER

32

- 32 About the warming drawer
- 33 Turning the warming drawer on or off



contents

OPERATING THE OVEN

34

- 34 The oven control panel
- 35 Setting the clock
- 36 Minimum and maximum settings
- 36 Setting the kitchen timer
- 37 Using the oven racks
- 38 Baking
- 39 Convection baking
- 41 Convection roasting
- 43 Timed cooking
- 44 Delay timed cooking
- 45 Broiling
- 47 Using the custom cook feature
- 48 Using the easy cook feature
- 49 Using the defrost function
- 50 Using the keep warm function
- 51 Extra features
- 53 Turning the oven light on and off
- 54 Setting the Sabbath Feature

MAINTAINING YOUR APPLIANCE

56

- 56 Self-cleaning
- 58 Steam-cleaning
- 59 Care and cleaning of the oven
- 61 Care and cleaning of the glass cooktop
- 63 Removing and replacing the oven door
- 64 Removing and replacing the warming drawer
- 65 Changing the oven light

TROUBLESHOOTING

66

- 66 Troubleshooting

WARRANTY

70

- 70 Warranty

introducing your new range

OVERVIEW

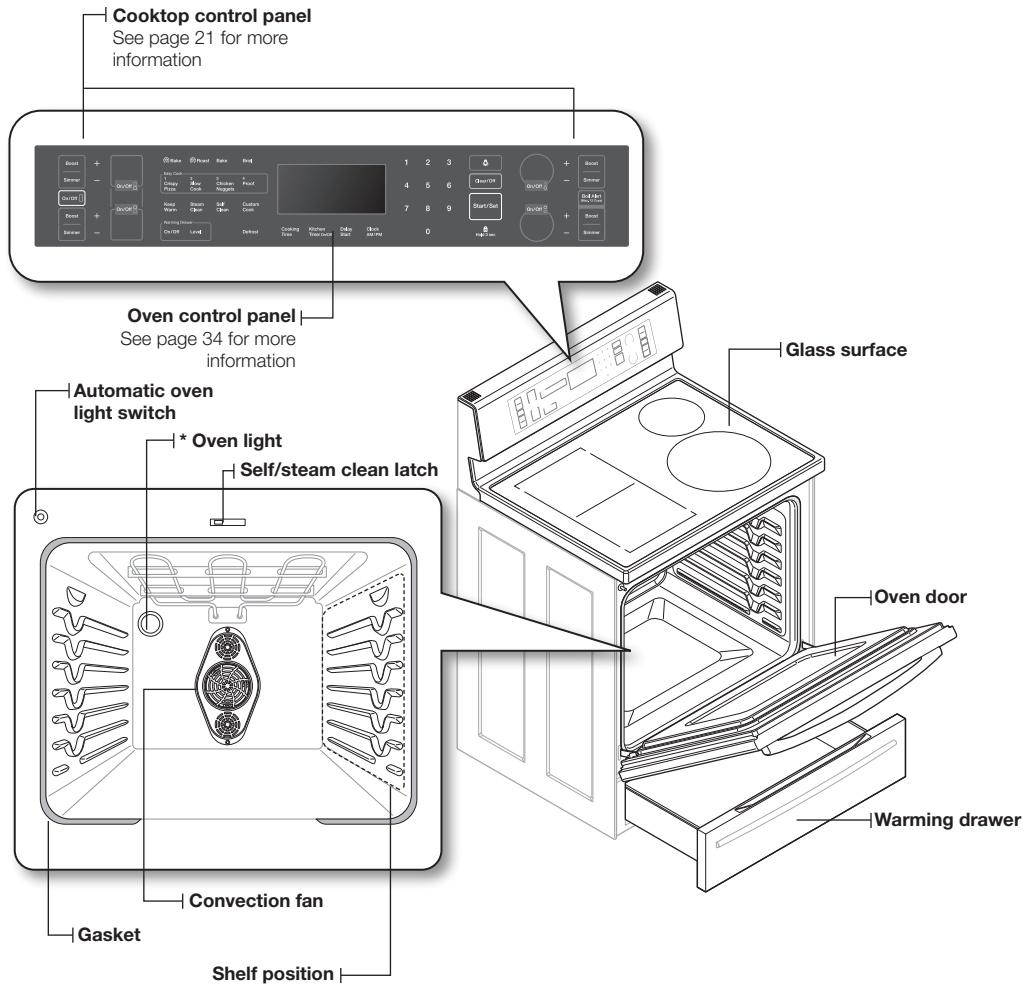

INTRODUCING

WHAT'S INCLUDED WITH YOUR RANGE

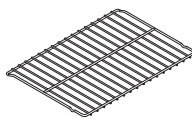

* Wire racks(2)

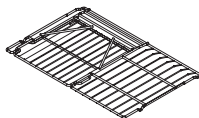

* Split rack(1)

If you need an accessory marked with a *, you can buy it from the Samsung Contact Center (1-800-726-7864).

induction cooktop cooking

ABOUT INDUCTION COOKTOP COOKING



CAUTION

BEFORE COOKING

- Do not use the Induction cooktop surface as a cutting board.
- Do not place or store items that can melt or catch fire on the Induction cooktop, even when it is not being used.
- Turn the induction cooktop on only after placing the cookware on them.
- Do not store heavy items above the cooktop surface. They could fall and damage it.



CAUTION

DURING COOKING

- Metallic objects such as knives, forks, spoons and lids should not be placed on the induction cooktop surface since they can get hot.
- After use, switch off the induction element using its control. Do not rely on the pan detector.
- Use this appliance for normal cooking and frying in the home only. It is not designed for commercial or industrial use.
- Never use the induction cooktop range to heat the room.
- Take care when plugging electrical appliances into a power outlet near the cooktop. Power cords must not come into contact with the cooktop.
- Overheated fat and oil can catch fire quickly. Never leave surface units unattended when preparing foods in fat or oil, for example, when cooking french fries.
- Turn the cooking zones off after use.
- Always keep the control panels clean and dry.
- Never place combustible items on the induction cooktop. It may cause a fire.
- Do not use the induction cooktop to heat aluminium foil, products wrapped in aluminium foil or frozen foods packaged in aluminium cookware.
- There is the risk of burns from the appliance if used carelessly.
- Do not let cables from electrical appliances touch hot cookware or the hot surface of the induction range cooktop.
- Do not use the induction range to dry clothes.
- Never store flammable materials such as aerosols and detergents in the drawer or cupboards under the induction cooktop.



WARNING

- Users with Pacemakers and Active Heart Implants must keep their upper body at a minimum distance of 1 ft. (30cm) from induction cooking zones when it is turned on. If in doubt, you should consult the manufacturer of your device or your doctor.

**AFTER COOKING**

- Do not touch the Induction elements until they have cooled down.
- The surface can stay hot for some time after cooking is complete. If you touch the surface before it has had time to cool down sufficiently, you can burn yourself.
- Immediately clean spills on the cooking area to prevent a tough cleaning chore later.
- After you have activated elements on the cooktop, the internal fan may come on for cooling purposes.
- The fan activation time may differ depending on the temperature of internal sensor. (10 minutes or 20 minutes)
- If you have cabinet storage directly above the cooking surface, make sure that the items in the cabinet are infrequently used and can be safely stored in an area subjected to heat. Temperatures may be unsafe for items such as volatile liquids, cleaners or aerosol sprays.

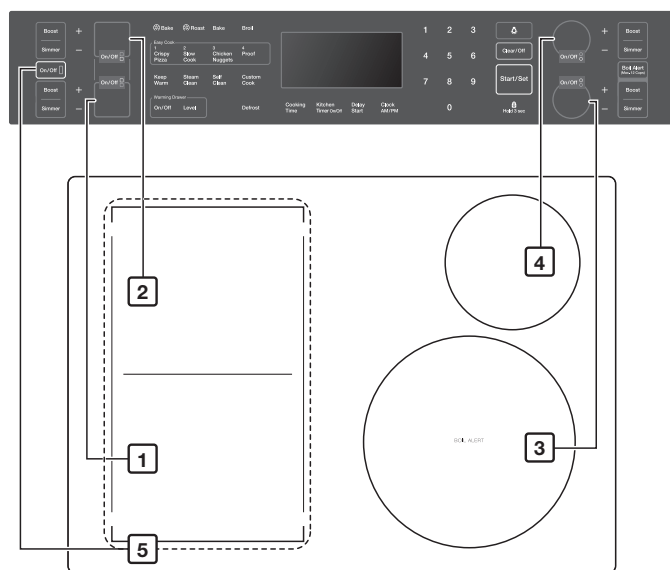
LOCATION OF THE INDUCTION COOKTOP ELEMENTS AND CONTROLS

1. Induction Left Front Cooking Zone
2. Induction Left Rear Cooking Zone
3. Induction Right Front Cooking Zone
4. Induction Right Rear Cooking Zone
5. Induction Flexcook zone

Safety instructions. Residual heat

- The Induction cooktop has a residual heat indicator for each element. It shows which elements are still hot. You should, therefore, avoid touching an element when this indicator is displayed.
- Although the Induction cooktop is switched off, the **H** indicator will stay lit while the element is still hot.
- If the pan has been removed but the element has not been switched off, the **H** indicator will flash, showing the power level selected.



INDUCTION TOUCH CONTROL

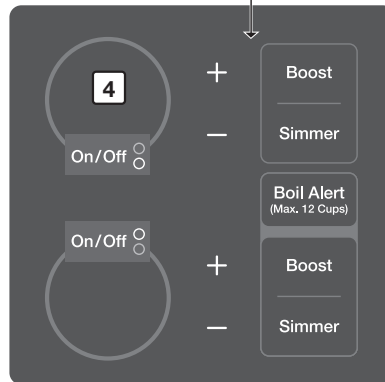
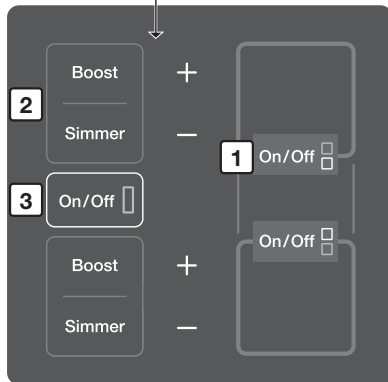

1. COOKING ZONE SELECTOR AND BURNER ON/OFF
2. POWER LEVEL SETTING SELECTORS
 - a. +,-
 - b. Boost
 - c. Simmer
3. FLEXCOOK ZONE BURNER ON/OFF
4. INDICATOR FOR
 - a. Power Setting(Lo~Hi)
 - b. Boost(P)
 - c. Simmer(Si)
 - d. Boil Alert(A)
 - e. Hot Surface(H)

- **Power Boost **Boost****: Use this function to heat up the contents of the pan faster than maximum power level **Hi**. (The display will show **P**)
- **Digital displays**: The four display fields are assigned to the four cooking zones. They show the following information:
 - **On** The appliance has been switched on.
 - **90, 40, 15, to 90, Hi, P** Selected power level settings.
 - **L** The child lock is activated.
 - **SE** Error message. The touch pad has been touched for longer than 1 minute. Example: The control touch is partially covered by a damp cloth or liquid has boiled over. To reset, touch the **On/Off Control**.
 - **AL** Error message. When the Induction cooktop is overheated because of abnormal operation. Example : Operating with empty cookware.
 - **U** Error message. Cookware is unsuitable or too small or no cookware has been placed on the cooking zone.
- **Flexcook Zone **F****: Use this function to expand the cooking zone over the entire left side.
- **Boil Alert**: After water is boiling, the Boil Alert function automatically reduces power to a power level you have selected and sounds a signal. (The display will show **A**.)

 Boil Alert function is only applicable to water boiling (mixing with other ingredients diminishes the effectiveness of the feature, so we recommend you to use power level control pads when cooking pasta etc.)

USING THE TOUCH CONTROL PADS

-  If more than one touch pad is pressed for longer than 1 minute, **SE** appears in the power setting display. To reset, touch the **On/Off control** pad.

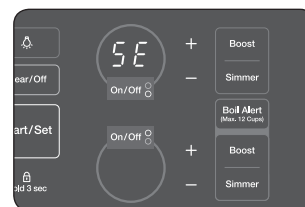

HOW TO SET THE APPLIANCE FOR COOKTOP COOKING



- The cooktop elements can be hot and can cause burns. Do not touch the surface elements until they have cooled down sufficiently.
- Never leave cooking food unattended when you set the heating element to 6 or higher. Boilovers cause smoke. Greasy spillovers may catch on fire.
- Be sure you turn the Touch control to **OFF** when you finish cooking.

SELECT COOKING ZONE ON

1. To switch on the cooking zone, touch the **On/Off** control pad.
2. The digital displays will show **---**.

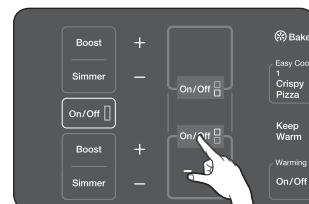

-  After you have activated the **On/Off** control pad to switch on your appliance, you must select a power setting within approximately 5 seconds. Otherwise, the appliance will switch itself off for safety reasons.

POWER SETTING

1. In the next 5 seconds, move your finger along the control panel until the desired power level setting appears in the digital display.
 - Display will show 5.0 when you select the + or - touch pad.

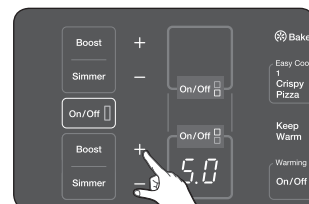

2. To set and adjust the power level from **L0** to **H1** for cooking, touch the Power level setting selectors (+ or -).

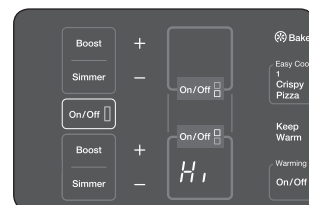

INDUCTION POWER BOOST CONTROL

The power boost function **Boost** makes additional power available to the induction cooking zone. Example: To bring a large volume of water to a boil.

The power boost function is activated for a maximum of 10 minutes for each cooking zone.

After Power Boost is finished, the cooking zones automatically return to power level **Hi**.

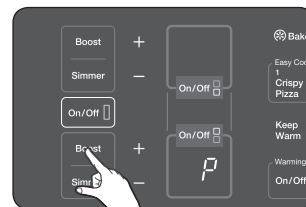

 In certain circumstances, the Power boost function may be deactivated automatically to protect the internal electronic components of the induction element.

INDUCTION SIMMER CONTROL

The simmer controls **Simmer** are used to simmer and keep large quantities of foods warm such as stews and soup.

The simmer settings of the small cooking zone are ideal for delicate foods and melting chocolate.

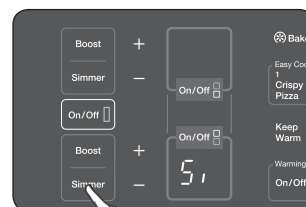

SWITCHING A COOKING ZONE OFF

To switch off a cooking zone, return the setting to **Off** by using the control panel's **Off control** pad.

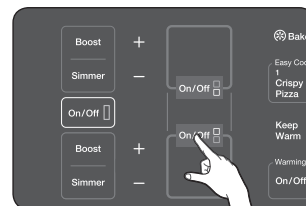

 After you switch off a cooking zone, the presence of residual heat is indicated by the 'Hot Surface indicator'.

FLEXCOOK ZONE CONTROL

- The Flexcook zone On control turns the displays for the left side front and rear elements on and off at the same time, combining the two elements into one. You can use the combined elements to heat a giant pan or griddle.

You can use the upper +/- or lower +/- key to adjust the power level.

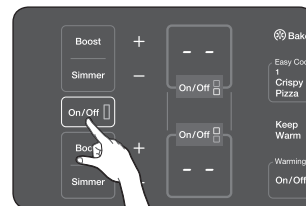

- When the Flexcook zone control is off and you are not using a giant pan or griddle, touch the on/off control of each Induction element to adjust the element's settings separately.

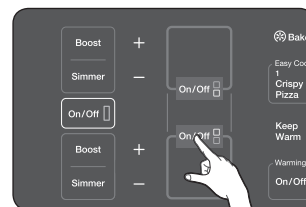



If you use the Flexcook Zone and place a pan on each of the front and rear burners, and then remove any one pan for about 1 minute, only the burner left will be enabled. (The Flexcook Zone key will be positioned to On whenever you use the Flexcook Zone function.) To reactivate the Flexcook zone function, touch the Flexcook Zone On/Off control to adjust the setting.

Using the Griddle

Type of Food	Preheat Time	Preheat Conditions	Cook Conditions
Pancakes	3 - 5 min.	4.0 - 4.5	4.0 - 4.5
Hamburgers	5 min.	4.0 - 4.5	4.0 - 4.5
Steak	5 min.	4.5 - 5.0	4.0 - 4.5
Fried Eggs	5 min.	4.0 - 5.0	4.0 - 4.5
Bacon	-	None	5.5 - 6.0
Breakfast Sausages	5 min.	4.0 - 4.5	4.0 - 4.5

- Effective temperature range of the griddle: Pancakes - 212~230 °F, Others - 275~320 °F
- To cook pancakes, we recommend you use a single burner in either the front or rear.
- We also recommend you use a griddle made of stainless steel rather than cast iron. (Note that the griddle made of cast iron may exceed the preheat time and cooking conditions suggested in "Using the Griddle".)



- The preheat time and cooking conditions vary depending on the pan, which may produce different cooking results.
- If you cook at a power level of 6 or greater, the cooking temperature will become too high, causing the griddle to smoke or your food to burn.
- Avoid cooking extremely greasy foods. Grease spill over can occur.
- Do not overheat the griddle. This can damage the non fixed coating.

Correct Pan Size and Pan Location for the Flexcook Zone

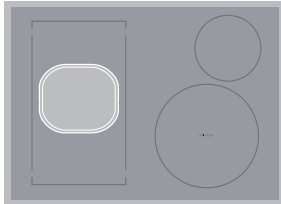
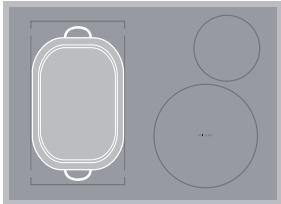
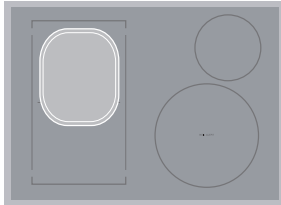
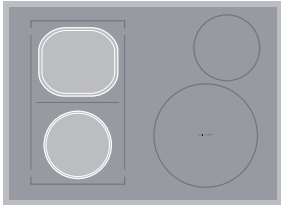
INCORRECT	CORRECT
 <ul style="list-style-type: none"> • Small size pan is located in center of Flexcook zone. 	 <ul style="list-style-type: none"> • Giant pan or Griddle.
 <ul style="list-style-type: none"> • Unsuitable size for Flexcook zone. see the "Size of Pans" section (28 page). 	 <ul style="list-style-type: none"> • 2 suitably sized pans for the Flexcook zone.

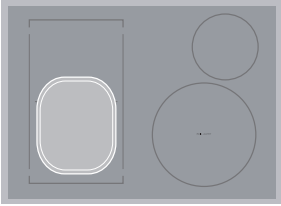
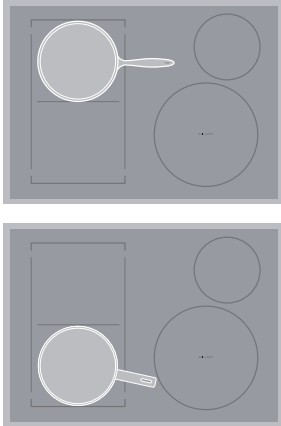

INCORRECT	CORRECT
 <ul style="list-style-type: none"> • Unsuitable size for Flexcook zone. See the “Size of Pans” section (28 page). 	 <ul style="list-style-type: none"> • Two examples of 1 suitably sized pan in the correct location in the Flexcook zone.

BOIL ALERT CONTROL (ONLY USE THE LARGEST BURNER)

The Boil Alert function automatically reduces power to a power level you have selected and sounds a signal.

1. Touch the **On/Off** control pad of the largest Burner (Right Front).

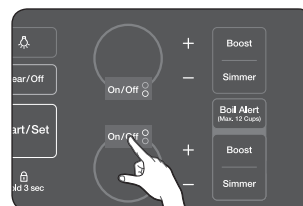

2. Touch the **Boil Alert** pad. The digital display will show **A**.

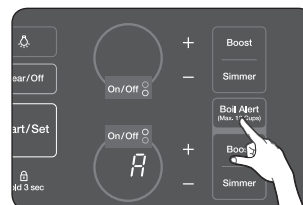

3. Touch the +/- pads to select the power level you want the element set to after the water boils. The range will automatically reduce the burner's power level to this level after the water boils and sound a signal (6 times).
 - If you want to adjust the power level while Boil Alert is in operation, touch the **Boil Alert** pad again and set the power level.
 - Required amount of water : 2 ~ 12 cups (500ml ~ 3000ml)

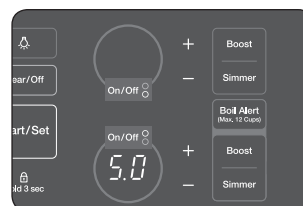



THE BOIL ALERT FEATURE IS NOT AN AUTOMATED SAFETY DEVICE. AS WITH ALL OTHER TYPES OF COOKING APPLIANCES, NEVER LEAVE THE INDUCTION COOKTOP UNATTENDED WHEN IT IS IN OPERATION, EVEN WHEN BOIL ALERT IS ACTIVATED. THE CONTENTS OF UNATTENDED COOKWARE MAY BOIL OVER, **POSING A RISK OF INJURY TO PERSONS OR DAMAGE TO PROPERTY FROM EXTREMELY HOT LIQUIDS OR FIRE.**



USE THE BOIL ALERT FUNCTION ONLY TO BOIL WATER. COMBINING OTHER INGREDIENTS (E.G. RICE, PASTA, POTATOES) WITH WATER WHILE USING THE BOIL ALERT FUNCTION MAY RESULT IN THE CONTENTS OF COOKWARE BOILING OVER AND ONTO THE COOKTOP WITHOUT ACTIVATING THE BOIL ALERT BEEP. **THIS MAY CAUSE INJURY TO PERSONS OR PROPERTY FROM EXTREMELY HOT LIQUID OR FIRE.**





-  Please note that the power level control pads(+/-,boost,simmer) are disabled once you activate the Boil alert function. **This is not a defect.** Please refer to the above text for instructions on how to change power levels during Boil alert operation.
-  The length of time it takes for the Boil alert beep to go off after the water reached the boiling point will vary. Factors that determine the timing of the alert beep include cookware diameter, amount of water in the cookware, the flatness of the cookware bottom surface(the flatter, the better) and iron content of cookware.
-  Since the Boil alert only works on the 11" element, we recommend that you use cookware that is at least 7.5" in surface diameter to enjoy the full benefit of Boil alert.

BEFORE USING THE COOKTOP

Use quality cookware in good condition

The cookware used with the cooktop surface should have flat bottoms that make good contact with the entire surface of the Cooking Zone. Check for flatness by rotating a ruler across the bottom of the cookware. Be sure to follow all the recommendations for using cookware.

Also remember to:

- Use cookware made with the correct material for induction cooking. See the "Correct Cookware Type" (28 page).
- Use quality cookware with heavier bottoms for better heat distribution allowing for more even cooking results.
- The pan size should match the amount of food being prepared.
- **Do not let pans boil dry.** This may cause permanent damage in the form of breakage, fusion, or marring that can affect the ceramic cooktop. (This type of damage is not covered by your warranty).
- Do not use dirty pans with grease buildup. Always use pans that are easy to clean after cooking.



- The Cooking Zones may appear to be cool while turned ON and after they have been turned OFF. The glass surface may be HOT from residual heat transferred from the cookware and burns may occur.



- **DO NOT TOUCH HOT COOKWARE or PANS directly with your hands.** Always use oven mitts or pot holders to protect your hands from burns.











- **DO NOT SLIDE cookware across the cooktop surface.** Doing so may permanently damage the appearance of the ceramic cooktop.



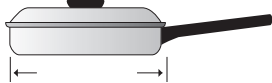
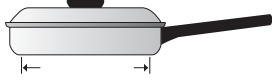
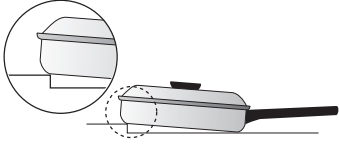

Use Quality Cookware in Good Condition

INCORRECT	CORRECT
 <ul style="list-style-type: none"> • Cookware not centered on Cooking Zone surface. 	 <ul style="list-style-type: none"> • Cookware centered correctly on Cooking Zone surface.
 <ul style="list-style-type: none"> • Curved or warped pan bottoms or sides. 	 <ul style="list-style-type: none"> • Flat pan bottom & straight sides.
 <ul style="list-style-type: none"> • Pan does not meet the minimum size required for the Cooking Zone used. See the "Size of pans" section (28 page). 	 <ul style="list-style-type: none"> • Pan size meets or exceeds the recommended minimum size for the Cooking Zone. See the "Size of pans" section (28 page).
 <ul style="list-style-type: none"> • Pan bottom rests on cooktop trim or does not rest completely on the cooktop surface. 	 <ul style="list-style-type: none"> • Pan rests completely on the Cooktop surface.
 <ul style="list-style-type: none"> • Heavy handle tilts pan. 	 <ul style="list-style-type: none"> • Pan is properly balanced.

 ANY one of the incorrect conditions listed above may be detected by the sensors located below the ceramic cooktop surface. If the cookware does not meet one or more of these conditions, one or more of the Cooking Zones will not heat, and settings will flash in the affected Cooking Zone display. Correct the problems before attempting to activate the cooktop.





COOKWARE FOR INDUCTION COOKING ZONES

The Induction element can only be turned on when cookware with a magnetic base is placed on one of the cooking zones. You can use the cookware identified as suitable below.

Cookware material

Cookware material	Suitable
Steel, Enamelled steel	Yes
Cast iron	Yes
Stainless steel	If appropriately labelled by the manufacturer
Aluminium, Copper, Brass	No
Glass, Ceramic, Porcelain	No

-  Cookware for induction cooking zone is labelled as suitable by the manufacturer.
-  Certain cookware can make noise when being used on induction cooking zones. These noise are not a fault in the appliance and do not affect operation in any way.

USE THE CORRECT SIZE COOKWARE

- The Induction Cooking Zones require a **minimum** pan size to be used at each location. The inner ring of each Cooking Zone is your guide to the correct **minimum** pan size. The pan bottom must fully cover the inner ring for proper cooking to occur.
 - The thicker outer ring at each Cooking Zone is helpful to determine the **maximum** pan size. After centering the cookware on the cooktop, make sure the cookware does not extend more than 1/2" beyond the thicker line on the Cooking Zone. The pan must fully contact the glass surface without the bottom of the pan touching the metal cooktop trim.
-  If a pan made of the correct material is centered properly on any of the active Cooking Zones but is too small, the affected Cooking Zone display will flash and the pan will not heat.

SIZE OF PANS

Induction cooking zones adapt automatically to the size of the bottom of the cookware up to a certain limit. However the magnetic part of the bottom of the cookware must have a minimum diameter depending upon the size of the cooking zone.

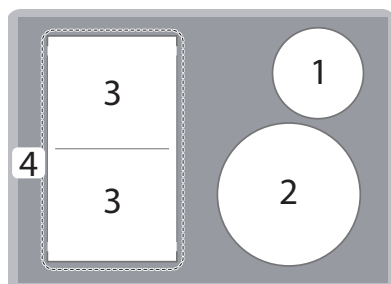

Cooking zones	Minimum diameter of the bottom of the cookware
1	5 "/ 145 mm
2	7.5 "/ 190 mm
3	6 "/ 160 mm
4	Size to occupy more than 60% of the Flexcook zone

OPERATING NOISES

You may hear the following operating noises:

- Cracking noises : The cookware you are using is made of two or more different materials.
- Whistling : You are using more than two cooking zones and the cookware you are using is made of two or more different materials.
- Humming : You are using high power levels.
- Clicking : Electric switches are operating.
- Hissing, Buzzing : The cooling fan is operating.

These noises are normal and do not indicate any defects.

USING SUITABLE INDUCTION COOKWARE

Suitability test

Cookware is suitable for induction cooking if a magnet sticks to the bottom of the cookware and the cookware is labelled as suitable by the cookware manufacturer.

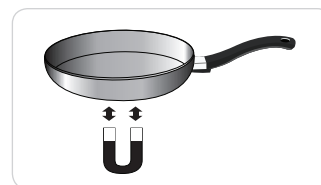

Better pans produce better results

- You can recognize good pans by their bases. The base should be as thick and flat as possible.
- When buying new pans, pay particular attention to the diameter of the base. Manufacturers often give only the diameter of the upper rim.
- Do not use pans which have damaged bases with rough edges or burrs. You can scratch the ceramic cooktop permanently if you slide a pan with a damaged base across the surface.
- When cold, pan bases are normally bowed slightly inwards (concave). They should never be bowed outwards (convex).
- If you wish to use a special type of pan, for example, a pressure cooker, a simmering pan, or a wok, please observe the manufacturer's instructions.

Energy saving tips

You can save valuable energy by observing the following points:

- Always position pots and pans before switching on the cooking zone.
- Dirty cooking zones and pan bases increase power consumption.
- When possible, position the lids firmly on pots and pans so that the lids cover them completely.
- Switch the cooking zones off before the end of the cooking time to use the residual heat for keeping foods warm or for thawing.

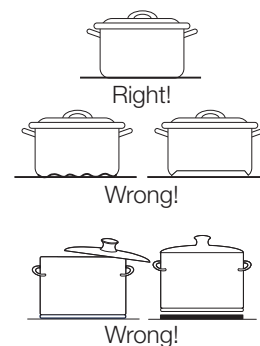

TEMPERATURE DETECTION

If for any reason the temperatures on any of the cooking zones were to exceed the safety levels, then the cooking zone will automatically reduce the heat to a lower power level.

When you have finished using the cooktop, the cooling fan will continue to run until the cooktop's electronics have cooled down. The cooling fan switches itself on and off depending upon the temperature of the electronics.

Power Management

The cooking zones, which consist of paired cooking elements, are restricted to drawing a certain maximum amount of power.

If you cause a cooking zone to exceed its maximum allowed power by switching on the Power Boost function, the Power Management function automatically reduces the power setting of the two elements in the cooking zone and reduces the power draw.

For example, the right side elements No.1 and No.2 are a cooking zone. If you have one element set at Hi, and turn on the Power Boost function for the other element, the Power Management function reduces the power settings of one of the elements as described in the tables below.

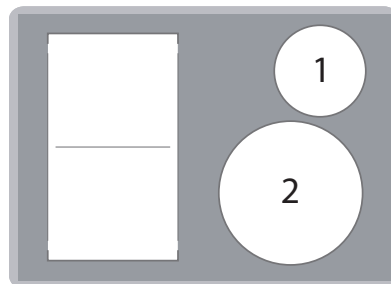

- Example

Power setting of Cooking Zone no.1	No. 2 setting	No. 1 power setting is automatically reduced to:
Power Boost	Power Boost is selected	Level 3.5
	Hi is selected	Hi

Power setting of Cooking Zone no.2	No. 1 setting	No. 2 power setting is automatically reduced to:
Power Boost	Power Boost is selected	Level 5.5
	Hi is selected	Hi

SUGGESTED SETTINGS FOR COOKING SPECIFIC FOODS

The figures in the table below are guidelines. The power settings required for various cooking methods depend on a number of variables, including the quality of the cookware being used and the type and amount of food being cooked.

Setting	Cooking method	Examples for Use
8-Hi	Intensive Frying Boiling	Rapid boiling Deep frozen foods
6-8	Frying Stewing Boiling	Pancakes, Steak, Cutlet. Grilled meat Clear soup Pasta cooking
4-6	Frying Stewing Boiling	Egg, fried Thick soup, sauce and gravies Slow boiling rice and milk dishes Potato cooking
2-4	Poaching Defrosting	Soft vegetable cooking Defrosting frozen vegetable



Setting	Cooking method	Examples for Use
Lo-2	Melting, Warming	Melting chocolate and butter, dissolving gelatin, simmer, keep warm.



- The power settings indicated in the table above are provided only as guidelines for your reference.
- You will need to adjust the power settings according to specific cookware and foods.

PROTECTING THE COOKTOP SURFACE

Cleaning

- Clean the cooktop before using it for the first time.
- Clean your cooktop daily or after each use. This will keep your cooktop looking good and can prevent damage.
- If a spillover occurs while cooking, immediately clean the spill from the cooking area while it is hot to prevent a tough cleaning chore later. Using extreme care, wipe the spill with a clean dry towel.
- Do not allow spills to remain on the cooking area or the cooktop trim for a long period of time.
- **Do not** use abrasive cleansing powders or scouring pads, which will scratch the cooktop.
- **Do not** use chlorine bleach, ammonia, or other cleansers not specifically recommended for use on a glass-ceramic surface.

Preventing marks and scratches

- Do not use glass cookware. It may scratch the cooktop.
- **Do not** place a trivet or wok ring between the cooktop and the pan. These items can mark or scratch the cooktop.
- Make sure the cooktop and the pan bottom are clean.
- **Do not** slide metal pans across the cooktop.

Preventing stains

- **Do not** use a soiled dish cloth or sponge to clean the cooktop surface. A film will remain, which may cause stains on the cooking surface after the area is heated.
- Continuously cooking on a soiled surface may result in a permanent stain.

Preventing other damage

- Do not allow plastic, sugar, or foods with high sugar content to melt onto the hot cooktop. Should this happen, clean immediately.
- Do not let a pan boil dry as this will damage the cooktop and the pan.
- **Do not** use the cooktop as a work surface or cutting board.
- **Do not** cook food directly on the cooktop. Always cook food in the proper cookware.



using the warming drawer

ABOUT THE WARMING DRAWER

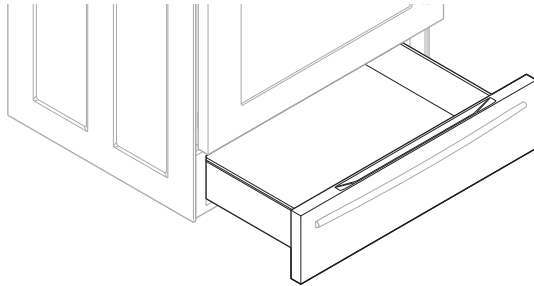

The **warming drawer** will keep hot, cooked foods warm. Always start with hot food. Do not use to warm cold food other than bread, crackers, chips or dry cereal.

Allow approximately 25 minutes for the warming drawer to preheat.

- **Do not line the warming drawer or pan with aluminum foil. Foil is an excellent heat insulator and will trap heat beneath it. This will upset the performance of the drawer and could damage the interior finish.**
- Do not put liquid or water in the warming drawer.
- All foods placed in the warming drawer should be covered with a lid. When warming pastries or breads, the cover should be vented to allow moisture to escape.
- Remove serving spoons, etc., before placing containers in the warming drawer.
- Food should be kept hot in its cooking container or transferred to a heat-safe serving dish.



Plastic containers or plastic wrap will melt if in direct contact with the drawer, pan or a hot utensil. Melted plastic may not be removable and is not covered under your warranty.

TURNING THE WARMING DRAWER ON OR OFF

1. Turn the warming drawer on.

Press the **WARMING DRAWER** On/Off pad.



2. Select the power setting you want.

Pressing the **WARMING DRAWER LEVEL** pad once for low, twice for medium, or 3 times for high.

The warming drawer starts automatically once you have finished selecting the level you want.



3. Turn the warming drawer off.

Press the **WARMING DRAWER** On/Off pad.



- Pressing the **CLEAR/OFF** pad does not turn the warming drawer off.
- The warming drawer cannot be used during a self-cleaning cycle.

Recommended settings

LEVELS		TYPE OF FOOD
	Low	Rolls (soft), empty dinner plates
	Medium	Gravies, eggs, biscuits, pastries, casseroles, vegetables, rolls (hard), roasts (beef, pork, lamb)
	High	Bacon, poultry, pizza, hamburger patties, pork chops, fried foods



- Different types of food may be placed in the warming drawer at the same time. For best results, do not leave food in the warming drawer for longer than 1 hour. Do not leave smaller quantities or heat-sensitive foods, such as eggs, for longer than 30 minutes.
- The warming drawer will shut off automatically after 3 hours.

operating the oven

THE OVEN CONTROL PANEL

READ THE INSTRUCTIONS CAREFULLY BEFORE USING THE OVEN. For the best results, familiarize yourself with the various features and functions of the oven as described below.

Detailed instructions for each feature and function follow later in this user manual.

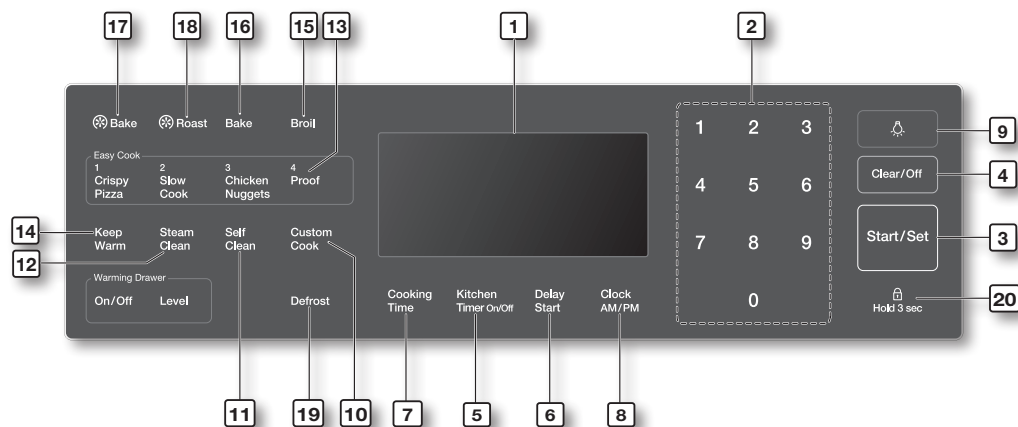

- 1. DISPLAY:** Shows the time of day, oven temperature, whether the oven is in the bake, broil or self-cleaning mode, and the times set for the timer or automatic oven operations.
- 2. NUMBER PAD:** Use to set any function requiring numbers such as the time of day on the clock, the timer, the oven temperature, the start time and length of operation for timed baking.
- 3. START/SET:** Must be pressed to start any cooking or cleaning function.
- 4. CLEAR/OFF:** Press to cancel all oven operations except the clock and timer.
- 5. KITCHEN TIMER ON/OFF:** Press to select the timer feature.
- 6. DELAY START:** Use with the Bake, Conv. Bake, Conv. Roast, Cooking Time, and Self Clean pads to set the oven to start and stop automatically at a time you set.
- 7. COOKING TIME:** Press and then use the number pad to set the amount of time you want your food to cook. The oven will shut off when the cooking time has run out. (Bake, Conv.bake /Roast only)
- 8. CLOCK:** Press to set the time of day.
- 9. OVEN LIGHT:** Press to turn the oven light on or off.
- 10. CUSTOM COOK:** Press to record and recall your favorite recipe setting.
- 11. SELF CLEAN:** Press to select the self-cleaning function.
- 12. STEAM CLEAN:** Press to select the steam-cleaning function.
- 13. PROOF:** Press to select a warm environment useful for rising yeast-leavened products.
- 14. KEEP WARM:** Press to keep cooked foods warm.
- 15. BROIL:** Press to select the broil function.
- 16. BAKE:** Press to select the bake function.
- 17. CONVECTION BAKE:** Press to select baking with the convection function.
- 18. CONVECTION ROAST:** Press to select roasting with the convection function.
- 19. DEFROST:** Press to select the defrost function.
- 20. CONTROL LOCKOUT:** Press to lock the buttons on the touch pad so they cannot be activated accidentally.

SETTING THE CLOCK

The **clock** must be set to the correct time of day for the automatic oven timing functions to work properly.

- The time of day cannot be changed during a timed cooking, a delay-timed cooking or a self-cleaning cycle.
- You can choose between a 12-hour or 24-hour display. The default is 12-hour.

How to set the clock

1. Start the set up.

Press the **CLOCK AM/PM** pad.

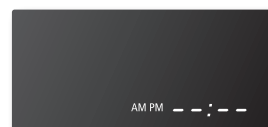

2. Select AM or PM.

Press the **CLOCK AM/PM** pad again, once to select AM or twice to select PM.

This step is skipped in the 24-hour display mode.



3. Enter the present time.

Enter the current time in hours and minutes on the number pad, eg. 1, 3, 0, for 1:30.



4. Exit the set up.

Press the **START/SET** or **CLOCK AM/PM** pad.

How to change between a 12-hour and 24-hour display

1. Start the set up.

Press **CLOCK AM/PM** and **0** on the number pad at the same time for 3 seconds.

The display will show the present mode (eg. 12 hour).



2. Select the display mode you want.

Press **0** on the number pad to select 12 hour or 24 hour.

Pressing **0** on the number pad toggles the display between 12 hour and 24 hour.



3. Exit the set up.



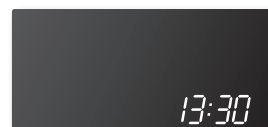





Press the **START/SET** pad.



MINIMUM AND MAXIMUM SETTINGS

All of the features listed in the table below have minimum and maximum time or temperature settings.

A beep will sound each time a pad on the control panel is pressed and the entry is accepted. An error tone will sound in the form of a long beep if the entered temperature or time is below the minimum or above the maximum setting for the feature.

FEATURE	MINIMUM	MAXIMUM
 Bake	150°F (65°C)	550°F (285°C)
 Broil	LO	HI
 Self Clean	2 Hr.	4 Hr.
 Convection Bake	150°F (65°C)	550°F (285°C)
 Convection Roast	150°F (65°C)	550°F (285°C)
 Keep Warm	-	3 Hr.
 Warming Drawer	-	3 Hr.
 Proof	-	12 Hr.
 Steam Clean	20 Min.	20 Min.

SETTING THE KITCHEN TIMER

The kitchen timer serves as an extra timer that will beep when the set time has elapsed. It does not start or stop cooking functions. You can use the kitchen timer with any of the other oven functions.

How to set the timer

1. Turn the timer on.

Press the **KITCHEN TIMER ON/OFF** pad.

2. Select the unit of time you want.

Press the **KITCHEN TIMER ON/OFF** pad once to select hours/minutes, twice to select seconds or three times to turn the kitchen timer off.

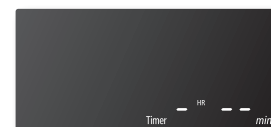

3. Enter the amount of time you want.

Enter the amount of time you want using the number pad, eg. 1, 5. The timer can be set for any amount of time from 1 minute to 9 hours and 99 minutes or 1 second to 99 minutes and 99 seconds. If you make a mistake, press the **KITCHEN TIMER ON/OFF** pad and start again.

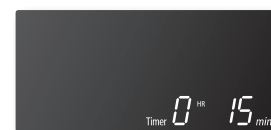

4. Start the timer.

Press the **KITCHEN TIMER ON/OFF** pad.

5. When the set time has elapsed, the oven will beep and the display will show End until you press the **KITCHEN TIMER ON/OFF** pad. You can cancel the timer at any time by pressing the **KITCHEN TIMER ON/OFF** pad.

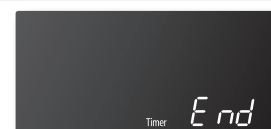

USING THE OVEN RACKS

Oven rack positions

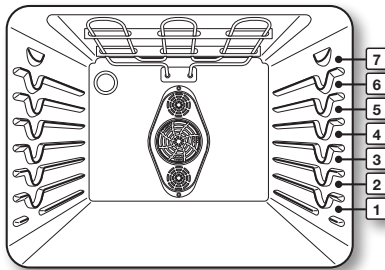

The oven has 7 rack positions (1~7).

TYPE OF FOOD	RACK POSITION
Frozen pies	4
Angel food cake	2
Bundt or pound cakes	3
Biscuits, muffins, brownies, cookies, cupcakes, layer cakes, pies	4
Casseroles	4
Small roast, ham	2
Turkey, large roast	1

Baking layer cakes

Centering the baking pans in the oven as much as possible will produce better results. If baking with more than one pan, place the pans so each has at least 1" to 1½" of air space around it. If baking four cake layers at the same time, place the oven racks in positions 2 and 5. If baking two cake layers at the same time, place one oven rack in position 4. Place the pans or cookware as show in Fig. 1 and Fig 2.

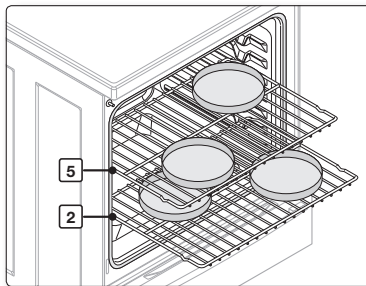

Fig. 1

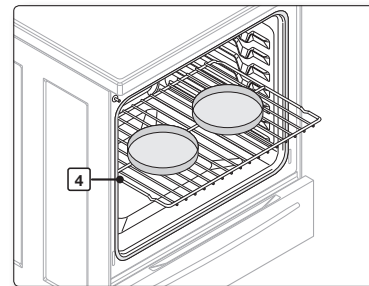

Fig. 2

Before using the racks

The oven has three racks.

Each rack has stops that need to be placed correctly on the supports. These stops will keep the rack from coming completely out.

Split rack

The right side of the split rack can be removed to accommodate a large roaster on the lower rack.

- The removable section of the Split Rack can be used as a roasting rack in the broiling pan.
- Be careful when removing cooked food from the split rack to avoid burns.

REMOVING THE RACKS

1. Pull the rack straight out until it stops.
2. Lift up the front of the rack and pull it out.

REPLACING THE RACKS

1. Place the end of the rack on the support.
2. Tilt the front end up and push the rack in.



- Do not cover a rack with aluminum foil or place on the oven bottom. This will disturb the heat circulation, resulting in poor baking, and may damage the oven bottom.
- Arrange the oven racks only when the oven is cool.

BAKING

The oven can be programmed to bake at any temperature from 150°F to 550°F.

How to set the thermostat

1. Start the set up.

Press the **BAKE** pad. The default temperature is 350°F.

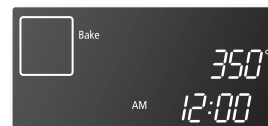

2. Enter the temperature you want on the number pad, eg. 3, 7, 5.

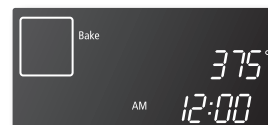

3. Start the bake function.

Press the **START/SET** pad. The temperature display will start to change once the oven temperature reaches 150°F.



4. If you want to cancel baking or if you have finished, press the **CLEAR/OFF** pad.

 Place food in the oven after preheating if the recipe calls for it. Preheating is very important for good results when baking cakes, cookies, pastry, and breads. After the oven has reached the desired temperature, a long beep will sound 6 times.

How to adjust the thermostat while cooking

1. Start the set up.

Press the **BAKE** pad. The display will show the present temperature, eg. 375°F.

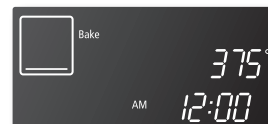

2. Enter the temperature you want, eg. 425°F, by using the number pad.

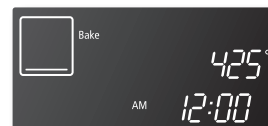

3. Complete the entry by pressing the **START/SET** pad.

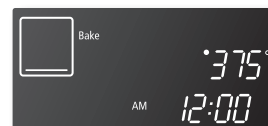

CONVECTION BAKING

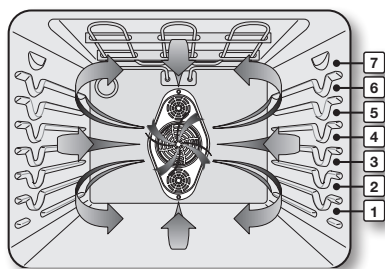

By using the convection bake feature, you will be able to cook faster. You can program the oven for convection baking at any temperature between 150°F and 550°F.

Convection baking uses a fan to circulate the oven's heat evenly and continuously within the oven. This improved heat distribution allows for even cooking and excellent results using multiple racks at the same time. Foods cooked on a single oven rack will generally cook faster and more evenly with convection baking. Multiple oven

rack cooking may slightly increase cook times for some foods, but the overall result is time saved. Breads and pastries brown more evenly.

Tips for convection baking

The amount of time you save will vary depending on the amount and type of food you are cooking. When baking cookies or biscuits, you should use pans with no sides or very low sides to allow the heated air to circulate around the food. Using a pan with a dark finish will allow faster cooking times.

When using convection baking with a single rack, place the oven rack in **position 4**. If cooking on multiple racks, place the oven racks in **positions 2 and 5** or **3, and 6**.

When baking a cake, using the bake mode will produce better results.

How to set the oven for convection baking

1. Start the convection baking mode.

Press the **CONV. BAKE** pad. The default temperature is 350°F.

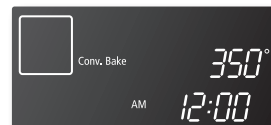

2. Enter the temperature you want, eg. 400°F, using the number pad.

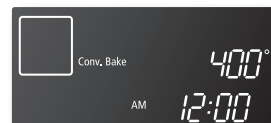

3. Press the **START/SET** pad to begin convection baking.

Conv. Bake and the adjusted oven temperature, eg. 400°F, will appear in the display for 2 seconds.

The temperature display will start to change once the oven temperature reaches 150°F.

A beep will sound 6 times when the oven reaches the adjusted oven temperature.

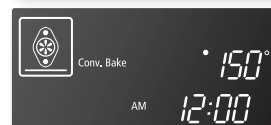
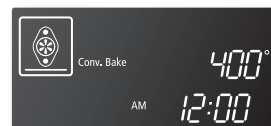

4. To turn off or cancel convection baking, press the **CLEAR/OFF** pad.



The convection oven fan shuts off when the oven door is opened.

DO NOT leave the door open for long periods of time while using convection cooking or you may shorten the life of the convection heating element.

Recommended convection baking guide

Food Item	Rack Position	Set Temp.* (preheated oven) °F	Convection bake time ** (min)
Cake			
Cupcakes	4	325	17-19
Bundt Cake	3	325	35-43
Angel Food	2	325	35-39
Pie			
2 crust, fresh, 9"	3	350-400	45-55
2 crust, frozen fruit, 9"	3	350	68-78
Cookies			
Sugar	4	325-350	12-17
Chocolate Chip	4	325-350	14-18
Brownies	4	325	29-36
Breads			
Yeast bread, loaf, 9x5	3	350	18-22
Yeast rolls	4	350-375	13-18
Quick Bread, loaf, 8x4	3	325-350	45-55
Biscuits	4	350-375	9-14
Muffins	4	400	15-19
Pizza			
Frozen	4	375-425	23-26
Fresh	4	400-425	12-15



* Actual times depend on the mixes or recipes baked.

CONVECTION ROASTING

Convection roasting is good for cooking large tender cuts of meat, uncovered.

Heat comes from the top heating element. The convection fan circulates the heated air evenly over and around the food. Meat and poultry are browned on all sides as if they were cooked on a rotisserie. The heated air seals in juices quickly for a moist and tender product while, at the same time, creating a rich golden brown exterior.

How to set the oven for convection roasting

1. Start the convection roasting mode.

Press the **CONV. ROAST** pad. The default temperature is 350°F.

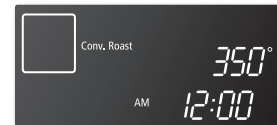

2. Enter the temperature you want, eg. 400°F, using the number pad.

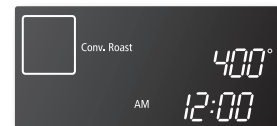

3. Press the **START/SET** pad to begin convection roasting.

Conv. Roast and the adjusted oven temperature, eg. 400°F, will appear in the display for 2 seconds.

The temperature display will start to change once the oven temperature reaches 150°F.

A beep will sound 6 times when the oven reaches the adjusted oven temperature.

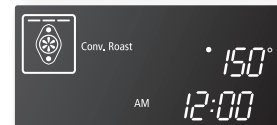
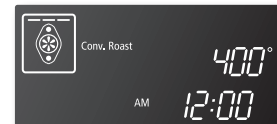

4. To turn off or cancel convection roasting, press the **CLEAR/ OFF** pad.



The convection oven fan shuts off when the oven door is opened.

DO NOT leave the door open for long periods of time while using convection cooking or you may shorten the life of the convection heating element.

Recommended convection roasting guide

Meat	Weight (lb)	Oven Temp. (°F)	Roasting time* (min per lb)	Internal temp. (°F)
Beef				
Rib Roast	4-6	350	25-28	145 (med/rare)
			28-32	160 (medium)
Rib Eye Roast, (boneless)	4-6	350	24-29	145 (med/rare)
			29-34	160 (medium)
Rump, Eye, Tip Sirloin (boneless)	3-6	350	25-30	145 (med/rare)
			28-35	160 (medium)
Tenderloin Roast	2-3	350	28-38	145 (med/rare)
Pork				
Loin Roast (boneless or bone-in)	5-8	375	15-25	170
Shoulder	3-6	375	20-30	160
Poultry				
Chicken - whole	3-4	400	17-23	180
Turkey, unstuffed**	12-15	350	12-16	180
Turkey, unstuffed**	16-20	350	11-15	180
Turkey, unstuffed**	21-25	350	8-12	180
Turkey Breast	3-8	325	20-25	170
Cornish Hen	1-1½	375	45-75 (total time)	180
Lamb				
Half Leg	3-4	350	25-30	160 (medium)
			30-35	170 (well)
Whole Leg	6-8	350	25-30	160 (medium)
			30-35	170 (well)



* Roasting times are approximate and may vary depending on the shape of the meat.

** Stuffed turkey requires additional roasting time. The minimum safe temperature for stuffing in poultry is 165~170°F.

TIMED COOKING

In timed cooking, the oven turns on immediately and cooks for the length of time you select. At the end of the cooking time, the oven turns off automatically.

- You can use the timed cooking feature only with another cooking operation (bake, convection bake, or convection roast).
- You can set the oven for timed cooking before setting other cooking operations.
- The clock must be set to the current time.

How to set the oven for timed cooking

1. Enter the set up.

Press the pad for the cooking operation you want, eg. BAKE. The default temperature is 350°F.

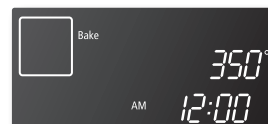

2. Enter the temperature you want, eg. 375°F, using the number pad.

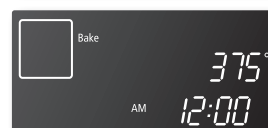

3. Press the **COOKING TIME** pad.



4. Enter the cooking time you want, eg. 45 min, using the number pad.

You can set the cooking time for any amount of time from 1 minute to 9 hours and 99 minutes.



5. Press the **START/SET** pad to begin the cooking operation.

The temperature display will start to change once the oven temperature reaches 150°F.

The oven will continue to cook until the set amount of time has elapsed, then turn off automatically unless the keep warm feature was set. (Refer to the section on the keep warm feature on page 50.)



6. You can cancel a timed cooking at any time by pressing the **CLEAR/OFF** pad.

- ★ Place food in the oven after preheating if the recipe calls for it. Preheating is important for good results when baking cakes, cookies, pastry, and breads. After the oven has reached the desired temperature, a long beep will sound 6 times.



Use caution with the **timed cooking** or **delay timed cooking** features. Use these features when cooking cured or frozen meats and most fruits and vegetables. Foods that can easily spoil, such as milk, eggs, fish, meat, or poultry, should be chilled in the refrigerator first. Even when chilled, they should not stand in the oven for more than 1 hour before cooking begins, and should be removed promptly when cooking is completed. Eating spoiled food can result in sickness from food poisoning.

DELAY TIMED COOKING

In a delay timed cooking, the oven's timer turns the oven on and off at times you select in advance.

- You can use the delay timed cooking feature only with another cooking operation (bake, convection bake, or convection roast).
- You can set the oven for a delay timed cooking before setting other cooking operations.
- The clock must be set to the current time.

How to set the oven for delay timed cooking

1. Position the oven rack(s) and place the food in the oven.

2. Enter the set up.

Press the pad for the cooking operation you want, eg. BAKE. The default temperature is 350°F.

3. Use the number pads to enter the temperature you want, eg. 375°F.

4. Press the **COOKING TIME** pad.

5. Enter the cooking time you want, eg. 45 min, by using the number pad.

You can set the cooking time for any amount of time from 1 minute to 9 hours and 99 minutes.



6. Press the **DELAY START** pad.

"AM, PM" is not displayed in 24 hour mode.

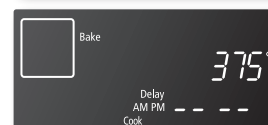

7. Select AM or PM.

Press the **CLOCK AM/PM** pad once to select AM or twice to select PM.

This step is skipped in the 24-hour display mode.



8. Enter the time you want the oven to turn on, eg. 4:30, using the number pad.



9. Press the **START/SET** pad.

At the set time, a short beep will sound. The oven will begin to bake. When the oven has reached the desired temperature, a long beep will sound 6 times.

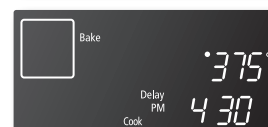

- ★ Place food in the oven after preheating if the recipe calls for it. Preheating is important for good results when baking cakes, cookies, pastry, and breads. After the oven has reached the desired temperature, a long beep will sound 6 times.

BROILING

Broil stop position

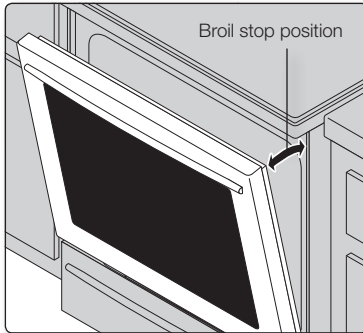

Leave the door open at the broil stop position. The door will stay open by itself, yet the proper temperature is maintained in the oven.



Should an oven fire occur, close the oven door and turn the oven off. If the fire continues, throw baking soda on the fire or use a foam-type fire extinguisher. Do not put water or flour on the fire. Flour can explode and water can cause a grease fire to spread and cause personal injury.

How to set the oven for broiling

1. Select the broil setting you want.

Press the **BROIL** pad once for HI or twice for LO.

Use LO to cook foods such as poultry or thick cuts of meat thoroughly without over-browning them.

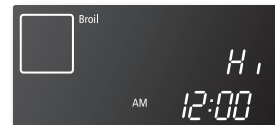

2. Start the broiling function.

Press the **START/SET** pad.

Broil on one side until food is browned; turn and cook on the other side.

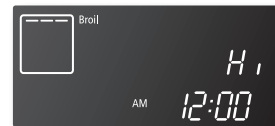

3. Press the **CLEAR/OFF** pad once you have finished cooking or if you want to cancel broiling.

Recommended broiling guide

The size, weight, thickness, starting temperature, and your doneness preference will affect broiling times.

This guide is based on meats at refrigerator temperature.

Food	Quantity and/or thickness	Shelf position	First side time (min.)	Second side time (min.)	Comments
Ground Beef Well Done	1 lb. (4 patties) ½ to ¾" thick	7	8-10	4-6	Space evenly. Up to 8 patties may be broiled at once.
Beef Steaks					
Rare	1" thick	7	8	3-5	Steaks less than 1" thick. Cook through before browning.
Medium	1 to 1½ lbs.	7	10	4-6	
Well Done		7	12	5-7	
Rare	1½" thick	6	14	7-9	Pan frying is recommended.
Medium	2 to 2½ lbs.	6	16	8-11	Slash fat.
Well Done		6	19	11-13	
Chicken	1 whole cut up 2 to 2½ lbs., split lengthwise	4	23-28	13-18	Broil skin-side-down first.
	2 Breasts	5	13-18	5-10	
Lobster Tails	2-4 10 to 12 oz. each	4	14-18	Do not turn over.	Cut through back of shell. Spread open. Brush with melted butter before broiling and halfway through broiling time.
Fish Fillets	¼ to ½" thick	6	5-9	3-4	Handle and turn very carefully. Brush with lemon butter before and during cooking, if desired.
Ham Slices (precooked)	½" thick	6	5-7	3-5	Increase time 5 to 10 minutes per side for 1½" thick or home-cured ham.
Pork Chops	2 (½" thick)	6	7	6-8	Slash fat.
Well Done	2 (1" thick) about 1 lb.	5	9-10	7-9	
Lamb Chops					
Medium	2 (1" thick) about 10 to 12 oz.	6	6	4-6	Slash fat.
Well Done		6	8	7-9	
Medium	2 (1½" thick) about 1 lb.	6	11	9	
Well Done		6	13	9-11	
Salmon	2 (1" thick)	6	8	3-4	Grease pan. Brush steaks with melted butter.
Steaks	4 (1" thick) about 1 lb.	6	9	4-6	

USING THE CUSTOM COOK FEATURE

By using the custom cook feature, you can record up to 3 different recipe settings. The feature may be used for baking, convection baking, or convection roasting. It will not work with any other function, including the delay start feature.

How to record a recipe setting

1. Press the pad for the cooking operation you want to store, eg. BAKE. The default temperature is 350°F.
2. Use the number pad to enter the temperature you want, eg. 375°F.



3. You can store a recipe setting in one of three **CUSTOM COOK** positions. Press the **CUSTOM COOK** pad the number of times that corresponds to the position in which you want to store the setting. eg. for **CUSTOM COOK** position 2, press the **CUSTOM COOK** pad twice.

Recipe settings can be stored at position 1, 2, or 3.

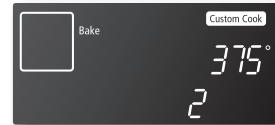
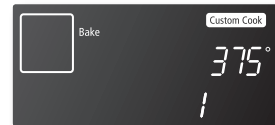

4. Press the **START/SET** pad.



How to recall a setting

1. Press the **CUSTOM COOK** pad the number of times that corresponds to the position in which the recipe setting is stored, eg. for **CUSTOM COOK** position 2, press the **CUSTOM COOK** pad twice.

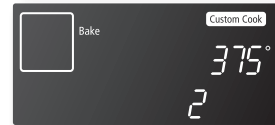
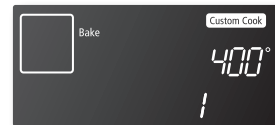

2. Start the stored cooking operation.
Press the **START/SET** pad.

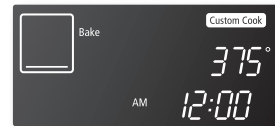

USING THE EASY COOK FEATURE

Slow Cook

The Slow Cook feature cooks food more slowly at lower oven temperatures. The extended cooking times allow better distribution of flavors in many recipes. This feature is ideal for roasting beef, pork, and poultry. Slow cooking meats may result on the exterior of meats becoming dark but not burnt. This is normal.

1. To enter the **Slow cook** mode, press the **Slow Cook** pad once for **Hi** or twice for **LO**.
2. To start the Slow cook function, press the **START/SET** pad.



Use only 1 rack and place the rack in position 2 or 3 for the best results. Preheating the oven is not necessary.

Chicken Nuggets

The Chicken Nuggets feature lets you cook convenience style frozen chicken nuggets easily.

1. To enter the **Chicken Nuggets** mode, press the **Chicken Nuggets** pad once for **Hi** or twice for **LO**.
2. To start the Chicken Nuggets function, press the **START/SET** pad.



When using this function, place the oven rack in position 5 of 6 for the best result. Preheating the oven is not necessary.

Proof

The proofing feature maintains a warm environment useful for rising yeast-leavened products.

1. To enter the **Proof** mode, press the **Proof** pad.
2. To start the proofing function, press the **START/SET** pad. The proofing feature automatically provides the optimum temperature for the proof process, and therefore does not have a temperature adjustment.
3. Press the **CLEAR/OFF** pad at any time to turn off the proofing feature.



- If you press the **Proof** pad when the oven temperature is above 100°F, **Hot** will appear in the display. Because these functions produce the best results when started while the oven is cool, we recommend that you wait until the oven has cooled down and Hot disappears from the display.
- To avoid lowering the oven temperature and lengthening proofing time, do not open the oven door unnecessarily.
- Check bread products early to avoid over-proofing.
- Do not use the proofing mode for warming food or keeping food hot. The proofing oven temperature is not hot enough to hold foods at safe temperatures. Use the warm feature. (see next page).
- For best results, cover the dough with a cloth or with plastic wrap. The plastic may need to be anchored underneath the container so the oven fan will not blow it off.

Crispy Pizza

The pizza function is designed to give pizzas crisp, browned bottoms while keeping the topping moist.

1. Press the **Pizza** pad.
2. Press the **START/SET** pad to begin pizza cooking.



Use only 1 rack and place the rack in position 2 or 3 for the best results when using the pizza feature. The default temperature is 400°F. You may adjust the oven temperature to fit your needs. Follow the package instructions for preheating and baking times. The pizza setting is not timed. Be sure to monitor the time to finish cooking the pizza.

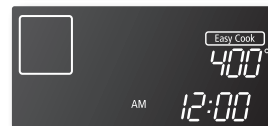
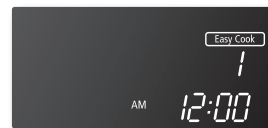

USING THE DEFROST FUNCTION

This function lets you defrost items in the oven much more quickly than at room temperature. The convection fan operates during defrosting.

How to set the Defrost function

1. Press the **DEFROST** pad.
The Defrost feature automatically provides the optimum temperature for the defrost process, and therefore does not have a temperature adjustment.
2. Press the **START/SET** pad.
3. Press the **CLEAR/OFF** pad at any time to turn off the defrost feature.

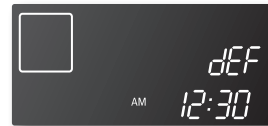

- If you press the **DEFROST** pad when the oven temperature is above 100°F, **Hot** will appear in the display. Because this function produces the best results when started while the oven is cool, we recommend that you wait until the oven has cooled down and Hot disappears from the display.
- Remove all packaging from the frozen food before defrosting for the best results.
- When defrosting food which has frozen together, e.g. berries, chops, fish fillets etc. separate it about half-way through the defrosting time.

USING THE KEEP WARM FUNCTION

The keep warm feature maintains an oven temperature of 170°F and will keep cooked food warm for serving up to 3 hours after cooking has finished.

After 3 hours, the feature will shut the oven off automatically. The feature may be used without any other cooking operations or may be set to activate after a timed or delay timed cooking operation.

You should not use this feature to reheat cold foods.

How to use the keep warm feature

1. Press the **KEEP WARM** pad.

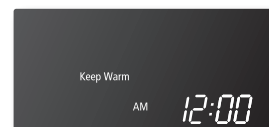

2. Press the **START/SET** pad.

3. Press the **CLEAR/OFF** pad at any time to turn the feature off.

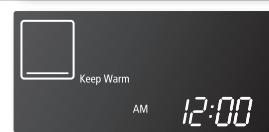

How to set the oven to activate the keep warm mode after a timed cooking

1. Set up the oven for **TIMED COOKING**.

(Refer to the section on the timed cooking feature on page 43.)

2. Press the **KEEP WARM** pad before pressing the **START/SET** pad to begin the cooking.

3. Press the **CLEAR/OFF** pad at any time to turn the feature off.



EXTRA FEATURES

12 hour energy saving

With this feature, should you forget and leave the oven on, the control will automatically turn off the oven after 12 hours during baking functions or after 3 hours during a broil function.

How to turn the 12 hour energy saving feature on or off

1. Press **COOKING TIME** and **0** on the number pad at the same time for 3 seconds.

The display will show **12 Hr** (12 hour shut-off) or **-- Hr** (no shut-off).

The default is 12 Hr.



2. Press **0** on the number pad to select OFF or ON.

Pressing **0** on the number pad toggles the mode between 12 Hr and -- Hr.



3. Press the **START/SET** pad.

Fahrenheit or Celsius temperature selection

The oven control can be programmed to display temperatures in Fahrenheit or Centigrade. The oven has been preset at the factory to display in Fahrenheit.

How to change the display from Fahrenheit to Centigrade or from Centigrade to Fahrenheit

1. Press **BROIL** and the **0** number pad at the same time for 3 seconds.

The display shows **F** (Fahrenheit) or **C** (Centigrade).

The default is F.



2. Press the **0** number pad to select F or C.

Pressing the **0** number pad toggles the display between F and C.



3. Press the **START/SET** pad.



Convection auto conversion feature

When you use the auto conversion feature, the convection auto conversion feature will automatically convert entered regular baking temperatures to convection baking temperatures.

If this feature is activated, the display will show the actual converted (reduced) temperature. For example, if you enter a regular recipe temperature of 350 °F and press the START/SET pad, the display will show the converted temperature of 325 °F.

How to disable or enable the auto conversion feature

1. Press **CONV. BAKE** and **0** on the number pad at the same time for 3 seconds.

The display will show **Con On** (enabled) or **Con OFF** (disabled).

The default setting is Con OFF.



2. Press **0** on the number pad to select Con On or Con OFF.

Pressing **0** on the number pad toggles the mode between Con On and Con OFF.



3. Press the **START/SET** pad.

Thermostat adjustment

The temperature in the oven has been preset at the factory. When first using the oven, be sure to follow recipe times and temperatures. If you think the oven is too hot or too cool, the temperature in the oven can be adjusted. Before adjusting, test a recipe by using a temperature setting that is higher or lower than the recommended temperature. The baking results should help you to decide how much of an adjustment is needed.

The oven temperature can be adjusted $\pm 35^{\circ}\text{F}$ ($\pm 19^{\circ}\text{C}$).

How to adjust the oven temperature

1. Press **BAKE** and **0** on the number pad at the same time for 3 seconds.

The display will show **Adj 0**.



2. Enter the adjustment you want, eg. 20°F, using the number pad.

You can adjust the temperature so that it is lower than the factory setting by pressing the **BAKE** pad.



3. Press the **START/SET** pad.



This adjustment will not affect the broiling or the self-cleaning temperatures. The adjustment will be retained in memory after a power failure.



Sound on/off

By using this feature, you can set the oven controls to operate silently.

How to turn the sound on or off

1. Press **Oven Light** and **0** on the number pad at the same time for 3 seconds.

The display will show **Snd On** (sound on) or **Snd OFF** (sound off).

The default setting is Snd On.



2. Press **0** on the number pad to select OFF or ON.

Pressing **0** on the number pad changes the mode between Snd On and Snd OFF.



3. Press the **START/SET** pad.

Control lockout

This feature will allow you to lock the buttons on the touch pad so they cannot be activated accidentally.

How to activate the control lockout feature

1. Press the **HOLD 3 SEC** pad for 3 seconds.

The display will show **Loc** and a Lock icon continuously, as well as the current time.

All functions must be cancelled before the control lockout is activated.

This function is available when the oven temperature is under 400°F.

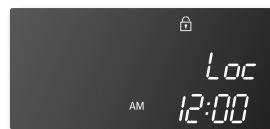

How to unlock the controls

1. Press the **HOLD 3 SEC** pad for 3 seconds.

Loc and the **lock icon** will disappear from the display.

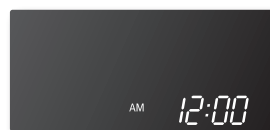

TURNING THE OVEN LIGHT ON AND OFF

- The oven light turns on automatically when the door is opened.
- The oven light turns off automatically when the door is closed.
- You can turn the oven light on and off manually by pressing the **OVEN LIGHT** pad.

SETTING THE SABBATH FEATURE

(For use on the Jewish Sabbath & Holidays)



For further assistance, guidelines for proper usage, and a complete list of models with the Sabbath feature, please visit the web at <http://www.star-k.org>.

You can use the Sabbath feature with baking only. The oven temperature may be set higher or lower after setting the Sabbath feature. (The oven temperature adjustment feature should be used only during Jewish holidays.) The display, however, will not change and tones will not sound when a change occurs. Once the oven is properly set for baking with the Sabbath feature active, the oven will remain on continuously until cancelled. This will override the factory preset 12 hour energy saving feature. If you need the oven light on during the Sabbath, press the **OVEN LIGHT** pad before activating the Sabbath feature. Once the oven light is turned on and the Sabbath feature is active, the oven light will remain on until the Sabbath feature is turned off. If the oven light needs to be off, be sure to turn the oven light off before activating the Sabbath feature.

How to use the Sabbath feature

1. Press the **BAKE** pad.

The default temperature is 350°F.

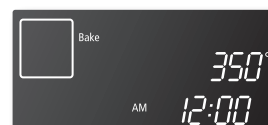

2. Enter the temperature you want, eg. 375°F, by using the number pad.

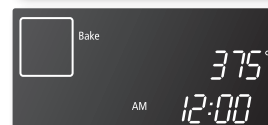

3. Press the **START/SET** pad.

The temperature display will start to change once the oven temperature reaches 150°F.

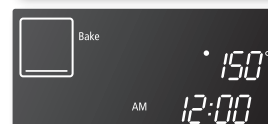

4. Press the **CLOCK AM/PM** and the **KITCHEN TIMER ON/OFF** pads at the same time for 3 seconds.





The display will show **SAb**.

Once SAb appears in the display, the oven will not beep or display any further changes.

You may change the oven temperature once baking has started. Remember that the oven will not beep or display any further changes once the Sabbath feature is engaged.



5. You can turn the oven off at any time by pressing the **CLEAR/OFF** pad. This will turn only the oven off. If you want to deactivate the Sabbath feature, hold down the **CLOCK AM/PM** and **KITCHEN TIMER ON/OFF** pads at the same time for 3 seconds. Sab will disappear from the display.

-  Do not attempt to activate any other program feature except BAKE while the Sabbath feature is active. ONLY the following key pads will function correctly with the Sabbath feature: **NUMBER, BAKE, START/SET** and **CLEAR/OFF** pad. **ALL OTHER KEYPADS** should not be used once the Sabbath feature is activated.
-  You can change the oven temperature, but the display will not change and tones will not sound when a change occurs. (The oven temperature adjustment feature should be used only on Jewish holidays.) After changing the temperature while the unit is in Sabbath mode there is a 15 seconds delay before the unit will recognize the change.
-  Should you experience a power failure or interruption, the oven will shut off. When power is returned, the oven will not turn back on automatically. SAb will be displayed in the oven control display, but the oven will not operate. The food may be safely removed from the oven while it is still in the Sabbath mode, however the oven cannot be turned back on until after the Sabbath/Holidays. After the Sabbath observance, turn OFF the Sabbath mode. Press and hold both CLOCK and TIMER ON/ OFF pads for at least 3 seconds simultaneously to turn the Sabbath mode off. The oven may be used with all normal functions.
-  Do not open the oven door or change the oven temperature for about 30 minutes after you have started Sabbath mode to allow the oven to reach the set temperature. Note that, for best performance, the oven fan operates only when the oven temperature is rising.
-  Do not use the cooktop when the oven is in the Sabbath MODE.

maintaining your appliance

SELF-CLEANING

This self-cleaning oven uses high temperatures (well above cooking temperatures) to burn off leftover grease and residue completely or reduce them to a finely powdered ash that you can wipe away with a damp cloth.



- During the self-cleaning cycle, the outside of the range will become very hot to the touch. **Do not** leave small children unattended near the appliance.
- Some birds can be sickened by the fumes given off during the self-cleaning cycle of any range. Move birds to another well-ventilated room.
- **Do not** line the oven walls, racks, bottom, or any other part of the range with aluminum foil. Doing so will result in poor heat distribution, produce poor baking results, and cause permanent damage to the oven interior. Aluminum foil will melt and adhere to the interior surface of the oven.
- **Do not** force the oven door open. This can damage the automatic door locking system. Use care when opening the oven door after the self-cleaning cycle is complete. Stand to the side of the oven when opening the door to allow hot air or steam to escape. The oven may still be **VERY HOT**.

Before a self-cleaning cycle

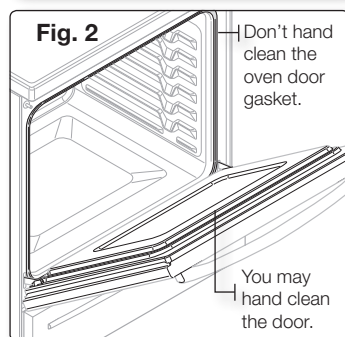
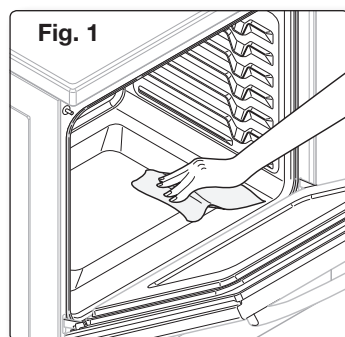

- We recommend venting your kitchen with an open window or using a ventilation fan or hood during the self-cleaning cycle.
- Remove the wire rack, broil pan, broil pan insert, all cookware, and any aluminum foil from the oven.
- Wipe up debris from the oven bottom. (Fig. 1)
- The silver-colored oven racks can be self-cleaned, but they will darken, lose their luster, and become hard to slide.
- Residue on the front frame of the range and outside the gasket on the door will need to be cleaned by hand. Clean these areas with hot water, soap-filled steel-wool pads, or cleansers such as Soft Scrub. Rinse well with clean water and dry.
- Do not clean the gasket. The fiberglass material of the oven door gasket cannot withstand abrasion. It is essential for the gasket to remain intact. If you notice it becoming worn or frayed, replace it. (Fig. 2)
- Make sure the oven light bulb cover is in place and the oven light is off.

How to set the oven for self-cleaning

1. Select the length of time for the self-cleaning operation, eg. 3 hours.

Press the **SELF CLEAN** pad once for a 3 hour clean time, twice for a 4 hour clean time, or 3 times for a 2 hour clean time.

The default setting is 3 hours.

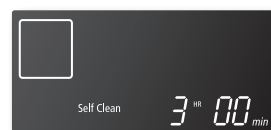

2. Start the self-cleaning cycle.

Press the **START/SET** pad. The motor-driven door lock will engage automatically.

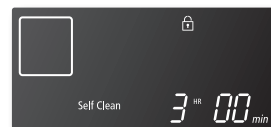

- ★ You will not be able to start a self-cleaning cycle if the control lockout feature is activated or if the oven's temperature is too hot.
- The oven door locks automatically. The display will show the clean time remaining. It is not possible to open the oven door until the temperature drops to a safe/cool temperature.
- The self-cleaning feature will not operate when the warming drawer is on.

How to delay the start of self-cleaning

1. Press the **SELF CLEAN** pad.
Select the desired self-clean time by pressing the **SELF CLEAN** pad.
2. Press the **DELAY START** pad.
3. Using the **CLOCK AM/PM** and number pads, enter the time you want the clean cycle to start
4. Press the **START/SET** pad.
The display will show **Delay, Self clean**, and the Lock icon. The motor-driven door lock will engage automatically.
5. The Self-Cleaning cycle will turn on automatically at the set time.

How to turn off the self-cleaning feature

You may find it necessary to stop or interrupt a self-cleaning cycle due to smoke in the oven. (When the self-cleaning cycle is done, End will show in the display and a beep will sound 6 times.)

1. Press the **CLEAR/OFF** pad.
2. You will be able to open the oven door once the oven has cooled down for approximately 1 hour.

After a self-cleaning cycle

- You may notice some white ash in the oven. Wipe it up with a damp cloth after the oven cools. (If white spots remain, remove them with a soap-filled steel wool pad and rinse thoroughly with a vinegar and water mixture.)
- If the oven is not clean after one cycle, repeat the cycle.
- You cannot set the oven for cooking until the oven is cool enough for the door to unlock.

STEAM-CLEANING

How to set the oven for steam-cleaning

For light cleaning, the Steam-cleaning function saves time and energy. For heavier-duty cleaning of debris and grease, use the self-cleaning function.

1. Remove all accessories from the oven.
2. Pour approximately 10 oz. (300 ml) of water onto the bottom of the empty oven and close the oven door.

Use normal water only, no distilled water.

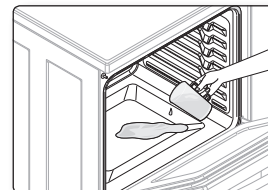

3. Press the **STEAM CLEAN** pad.

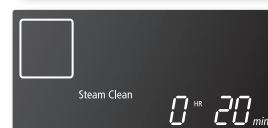

4. Press the **START/SET** pad.

When the operation is complete, the display will blink and a beep will sound.

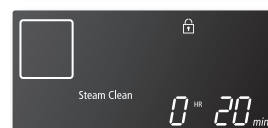

5. Press the **CLEAR/OFF** pad.

6. Clean the oven's interior.

There will be a significant amount of water remaining on the bottom of the oven after a steam-cleaning cycle. Remove the residual water with a sponge or soft dry cloth.

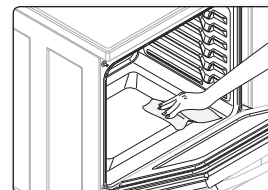

★ When steam-cleaning, use exactly 10 oz. of water since this produces the best results.

✍ If you press the **STEAM CLEAN** pad when the oven temperature is above 100°F, **Hot** will appear in the display. Because these functions produce the best results when started while the oven is cool, we recommend that you wait until the oven has cooled down and Hot disappears from the display.

After a steam-cleaning cycle

- Take care when opening the door before a steam-cleaning procedure has ended. The water on the bottom is hot.
- Open the oven door and remove the remaining water with a sponge. Do not leave the residual water in the oven for any length of time. Wipe the oven clean and dry with a soft cloth. Do not forget to wipe under the oven door seal.
- Use a detergent-soaked sponge, a soft brush, or a nylon scrubber to wipe the oven interior. Remove stubborn residue with a nylon scourer. You can remove lime deposits with a cloth soaked in vinegar.
- If the oven remains dirty, you can repeat the procedure once the oven has cooled.
- For heavy residue, such as grease left over from roasting, we recommend that you rub detergent into the residue before activating the steam-cleaning function.
- After cleaning, leave the oven door ajar at a 15° angle to allow the interior enamel surface to dry thoroughly.

CARE AND CLEANING OF THE OVEN



- **Be sure all controls are OFF and all surfaces are COOL before cleaning any part of the range.**
- **If your range is removed for cleaning, servicing, or any reason, be sure the Anti-Tip device is re-engaged properly when the range is replaced. If you fail to re-engage the Anti-Tip device, the range could tip and cause serious injury.**



Oven vent

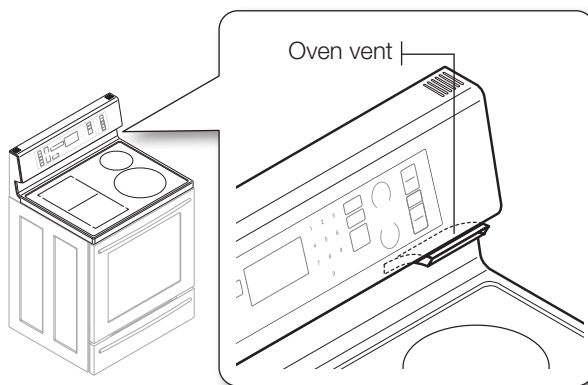

- The oven vent is located above the right rear surface unit.
- This area could become hot during oven use.
- It is normal for steam to come out of the vent.
- The vent is important for proper air circulation. Never block this vent.

Cleaning painted parts and decorative trim

- For general cleaning, use a cloth with hot and soapy water.
- For more difficult residue and built-up grease, apply a liquid detergent directly onto the area and leave for 30 to 60 minutes. Wipe with a damp cloth and dry. Do not use abrasive cleaners on any of these surfaces. They can scratch.

Cleaning stainless steel surfaces

1. Shake the bottle of Stainless Steel Appliance Cleaner or polish well.
2. Place a small amount of stainless steel appliance cleaner or polish on a damp cloth or damp paper towel.
3. Clean a small area, rubbing with the grain of the stainless steel if applicable.
4. Dry and buff with a clean, dry paper towel or soft cloth.
5. Repeat as necessary.



- **Do not use a steel-wool pad. It will scratch the surface.**
- If a mineral oil-based stainless steel appliance cleaner has been used before to clean the appliance, wash the surface with dishwashing liquid and water prior to using the Stainless Steel Appliance Cleaner or polish.



Oven racks

- If the racks are left in the oven during a self-cleaning cycle, their color will turn slightly blue and the finish will be dull. After the self-cleaning cycle is complete and the oven has cooled, rub the sides of the racks with wax paper or a cloth containing a small amount of oil. This will help the racks glide more easily into their tracks.

Oven door

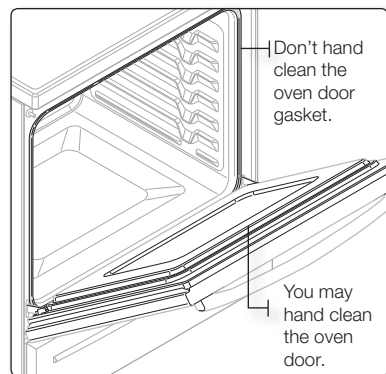

- Use soap and water to thoroughly clean the top, sides, and front of the oven door. Rinse well. You may use a glass cleaner on the outside glass of the oven door. **DO NOT** immerse the door in water. **DO NOT spray or allow water or the glass cleaner to enter the door vents.** **DO NOT** use oven cleaners, cleaning powders, or any harsh abrasive cleaning materials on the outside of the oven door.
- **DO NOT clean the oven door gasket.** The oven door gasket is made of a woven material which is essential for a good seal. Care should be taken not to rub, damage, or remove this gasket.



CARE AND CLEANING OF THE GLASS COOKTOP

Normal daily use cleaning

Use only a ceramic cooktop cleaner. Other creams may not be as effective.

By following these steps, you can maintain and protect the surface of your glass cooktop.

1. Before using the cooktop for the first time, clean it with a ceramic cooktop cleaner. This helps protect the top and makes cleanup easier.
2. Daily use of a ceramic cooktop cleaner will help keep the cooktop looking new.
3. Shake the cleaning cream well. Apply a few drops of cleaner directly to the cooktop.
4. Use a paper towel or a cleaning pad for ceramic cooktops to clean the entire cooktop surface.
5. Use a dry cloth or paper towel to remove all cleaning residue. No need to rinse.



DAMAGE to your glass surface may occur if you use scrub pads other than those recommended.

Removing burned-on residue

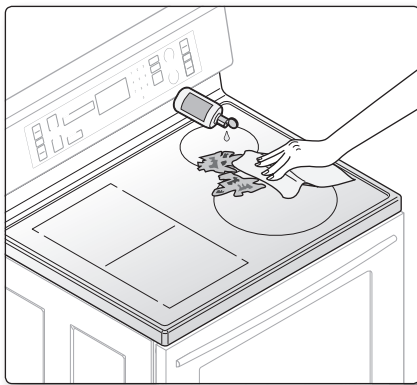

1. Allow the cooktop to cool.
2. Spread a few drops of ceramic cooktop cleaner on the entire burned residue area.
3. Using the cleaning pad for ceramic cooktops, rub the residue area, applying pressure as needed.
4. If any residue remains, repeat the steps listed above as needed.
5. For additional protection, after all residue has been removed, polish the entire surface with ceramic cooktop cleaner and a paper towel.

Removing heavy, burned-on residue

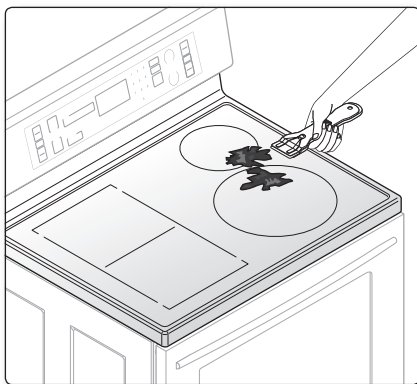

1. Allow the cooktop to cool.
2. Use a single-edge razor-blade scraper at approximately a 45° angle against the glass surface and scrape the soil. It will be necessary to apply pressure in order to remove the residue.
3. After scraping with the razor scraper, spread a few drops of ceramic cooktop cleaner on the entire burned residue area. Use the cleaning pad to remove any remaining residue. (Do not scrape the seal.)
4. For additional protection, after all residue has been removed, polish the entire surface with the cooktop cleaner and a paper towel.

Removing metal marks and scratches

1. Be careful not to slide pots and pans across your cooktop. It will leave marks on the cooktop surface. You can remove these marks by applying ceramic cooktop cleaner with a cleaning pad for ceramic cooktops.
2. If pots with a thin overlay of aluminum or copper are allowed to boil dry, the overlay may leave black discoloration on the cooktop. You should remove this discoloration immediately or it may become permanent.



Carefully check the bottoms of pans for roughness that may scratch the cooktop.

Cleaning the cooktop seal

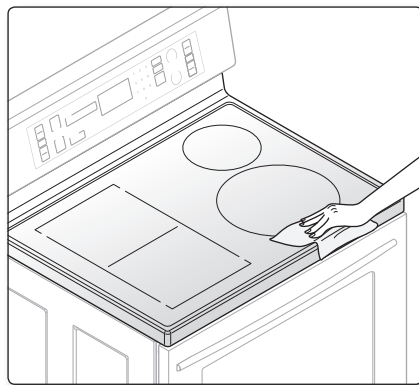

To clean the seal around the edges of the glass, lay a wet cloth on it for a few minutes, then wipe clean with a nonabrasive cleaner.

Potential for permanent damage to the glass surface

- Sugary spillovers (such as jellies, fudge, candy, syrups) or melted plastics can cause pitting of the surface of your cooktop. This is not covered under the warranty. You should clean the spill while it is still hot. Take special care when removing hot substances. Refer to the following section.
- When using a scraper, be sure it is new and the razor blade is still sharp. Do not use a dull or nicked blade.

Cleaning sugary spills and melted plastic

1. Turn off all surface units. Remove hot pans.
2. Wearing an oven mitt, use a single-edge razor-blade scraper to move the spill to a cool area of the cooktop. Remove the spill with paper towels.
3. Any remaining spillover should be left until the surface of the cooktop has cooled.
4. Don't use the surface units again until all of the residue has been completely removed.



If pitting or indentations in the glass surface have already occurred, the cooktop glass will have to be replaced. In this case, service will be necessary.

REMOVING AND REPLACING THE OVEN DOOR

How to remove the door



- The door is very heavy. Be careful when removing and lifting the door. Do not lift the door by the handle.
- Turn the power OFF before removing the door.

1. Open the door completely.
2. Pull the hinge locks down toward the door frame to the unlocked position.

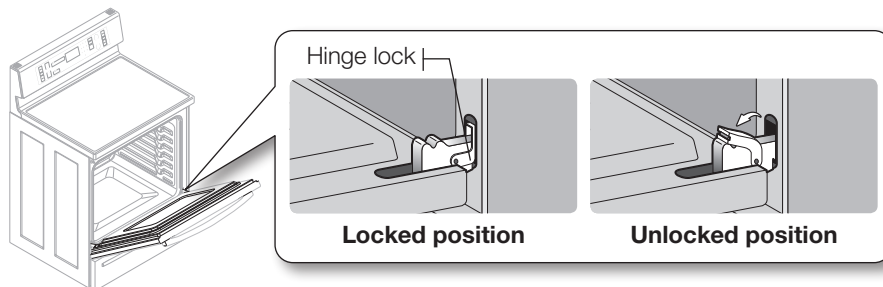

3. Firmly grasp both sides of the door at the top.
4. Close the door to the door removal position, which is approximately 5 degrees from vertical (Fig. 1).
5. Lift door up and out until the hinge arm is clear of the slot (Fig. 2).

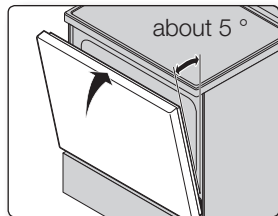

Fig. 1

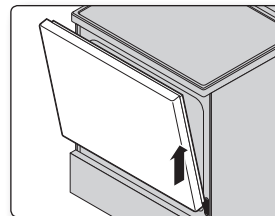
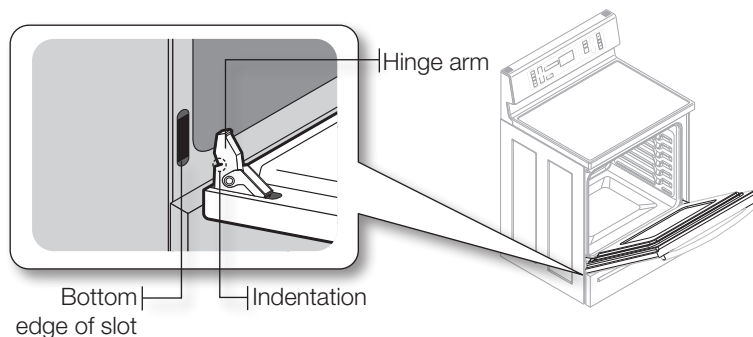

Fig. 2

How to replace the door

1. Firmly grasp both sides of the door at the top.
2. With the door at the same angle as the removal position, slide the indentation of the hinge arm into the bottom edge of the hinge slot. The notch in the hinge arm must be fully inserted into the bottom of the slot.





3. Open the door fully. If the door will not open fully, the indentation is not inserted correctly in the bottom edge of the slot.
4. Push the hinge locks up against the front frame of the oven cavity to the locked position.

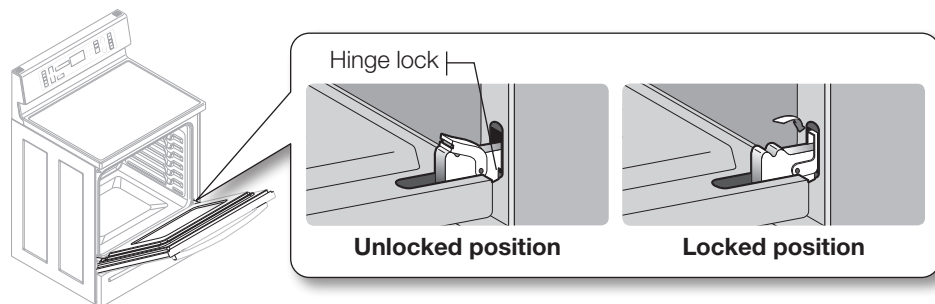

5. Close the oven door.

REMOVING AND REPLACING THE WARMING DRAWER



Turn the power OFF before removing the warming drawer.

How to remove the warming drawer

1. Pull out the drawer until it stops
2. Locate the locking clips near the back of each full-extension roller guide rail. Using two hands, push down on the left clip and lift up on the right clip to release the clips. Pull the drawer the rest of the way out.

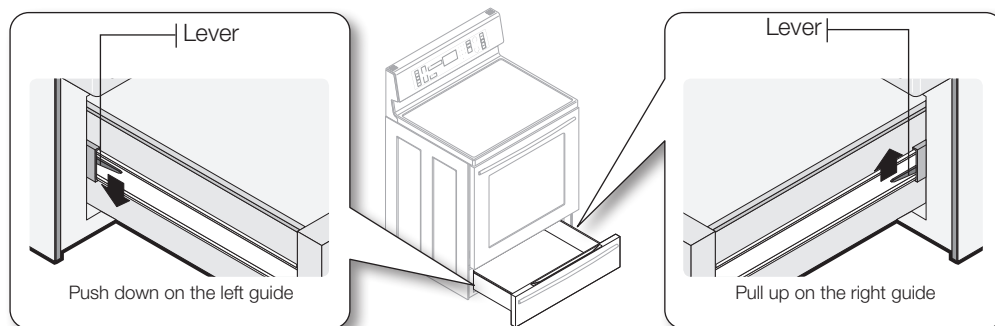

3. Pull the warming drawer away from the range.

How to replace the warming drawer

1. Position the ends of the full-extension roller guide rails in the side rails in the drawer opening.

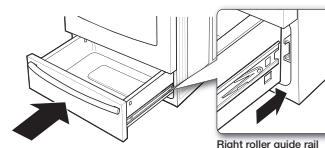

2. Push in the drawer to close it and snap the locking clips into place.

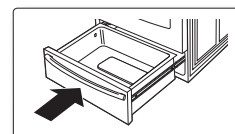

Changing the oven light

The oven light is a standard 40-watt appliance bulb. It will come on when the oven door is open. When the oven door is closed, press the **OVEN LIGHT** pad to turn it on or off. It will not work during a self-cleaning cycle.

1. Make sure the oven and the bulb are cool.
2. Unplug the range or disconnect power.
3. Turn the glass bulb cover in the back of the oven counterclockwise to remove.
4. Turn the bulb counterclockwise to remove it from its socket.

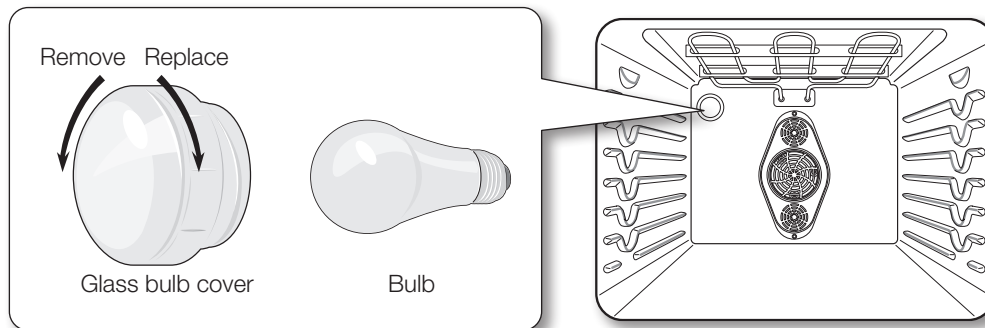

5. Replace the light bulb and glass bulb cover by turning them clockwise.
6. Plug in the range or reconnect power.



CAUTION

Before changing your oven light bulb, disconnect the electrical power to the range at the main fuse or circuit breaker panel. Make sure the oven and the bulb are cool.

troubleshooting

TROUBLESHOOTING

Samsung works hard to ensure that you don't have problems with your new electric range. If you run into unexpected trouble, look first for a solution in the table below. If, after trying the suggested solution, you're still having trouble, call Samsung at 1-800-SAMSUNG (1-800-726-7864).

PROBLEM	POSSIBLE CAUSE	SOLUTION
The range is not level.	The appliance has been installed improperly.	<ul style="list-style-type: none"> Place the oven rack in the center of the oven. Place a level on the oven rack. Adjust the leveling legs at the base of the range until the oven rack is level. Insure the floor is level and strong and stable enough to adequately support the range.
	The floor is sagging or sloping.	<ul style="list-style-type: none"> Contact a carpenter to correct the situation.
	The kitchen cabinets are not properly aligned and make the range appear to be not level.	<ul style="list-style-type: none"> Insure the cabinets are square and provide sufficient room for installation.
The appliance must be accessed for servicing and cannot be moved easily.	The kitchen cabinets are not square and built too tightly in to the appliance.	<ul style="list-style-type: none"> Contact a builder or installer to make the appliance accessible.
	Carpet is interfering with movement of the range.	<ul style="list-style-type: none"> Provide sufficient space so the range can be lifted over the carpet.
The oven control beeps and displays an error code.	You have a function error code.	<ul style="list-style-type: none"> Press the CLEAR/OFF pad and restart the oven. If the problem persists, disconnect all power to the range for at least 30 seconds and then reconnect the power. If this does not solve the problem, call for service.
	CODE CAUSE	
	-SE- Shorted key	
	E-27 Oven sensor opened	
	E-28 Oven sensor shorted	
	E-08 Oven heating error	
	E-0A Oven heating over	
	E-0E Door locking error	
E-84 Communication error		
The Cooktop control beeps and displays an error code.	You have a function error code.	<ul style="list-style-type: none"> Press touch the on/off control key pad. If the problem persists, disconnect all power to the range for at least 30 seconds and then reconnect the power. If this does not solve the problem, call for service. Call for service.
	CODE CAUSE	
	-SE- Touch pad Short Error	
	-LE- Low Voltage Error	
	-ot- Over Temperature Error	
	-□- Pan Detection Error	
	CODE CAUSE	
	-to- Top Sensor Open Error (Sensor-Top)	
	-t┐- Top Sensor Short Error (Sensor-Top)	
	-bo- IGBT Sensor Open Error (Assy-Inverter Module)	
	-b┐- IGBT Sensor Short Error (Assy-Inverter Module)	
	-FL- DC fan motor Error	



PROBLEM	POSSIBLE CAUSE	SOLUTION
The surface units will not maintain a rolling boil or will not cook fast enough.	Improper cookware is being used.	<ul style="list-style-type: none"> • Use pans which are flat and match the diameter of the surface unit selected.
	In some areas, the power (voltage) may be low.	<ul style="list-style-type: none"> • Cover the pan with a lid until the desired heat is obtained.
The surface units will not turn on.	A fuse in your home may be blown or the circuit breaker tripped.	<ul style="list-style-type: none"> • Replace the fuse or reset the circuit breaker.
	The cooktop controls are set improperly.	<ul style="list-style-type: none"> • Check to see the correct control is set for the surface unit you are using.
The surface unit stops glowing when changed to a lower setting.	This is normal. The unit is still on and hot.	
Areas of discoloration on the cooktop.	Food spillover was not cleaned.	<ul style="list-style-type: none"> • Refer to the section on care and cleaning of the glass cooktop on page 61.
	The surface is hot and the model features a light-colored cooktop.	<ul style="list-style-type: none"> • This is normal. The surface may appear discolored when it is hot. This is temporary and will disappear as the glass cools.
The surface unit frequently cycles on and off.	This is normal.	<ul style="list-style-type: none"> • The element will cycle on and off to maintain the power setting.
The oven will not turn on.	The range is not completely plugged into the electrical outlet.	<ul style="list-style-type: none"> • Make sure the electrical plug is inserted into a live, properly grounded outlet.
	A fuse in your home may be blown or the circuit breaker tripped.	<ul style="list-style-type: none"> • Replace the fuse or reset the circuit breaker.
	The oven controls have been set improperly.	<ul style="list-style-type: none"> • See the chapter on operating the oven.
	The oven is too hot.	<ul style="list-style-type: none"> • Allow the oven to cool.
The appliance will not turn on.	The appliance is not completely plugged into the electrical outlet or a fuse in your home may be blown or the circuit breaker tripped.	<ul style="list-style-type: none"> • Make sure the power cord is plugged into a live, properly grounded outlet. Check the fuse and circuit breakers.
	Incomplete service wiring.	<ul style="list-style-type: none"> • Call for service.
	Power outage.	<ul style="list-style-type: none"> • Check to see if the house lights will turn on. If required, call your local electric company for service.
The oven light will not turn on.	The light bulb is loose or defective.	<ul style="list-style-type: none"> • Tighten or replace the bulb.
	The switch operating light is broken.	<ul style="list-style-type: none"> • Call for service.
Oven smokes excessively during broiling.	The control has not been set properly.	<ul style="list-style-type: none"> • Refer to the section on setting oven controls. • Make sure the oven door is opened to the broil stop position.
	The meat has been placed too close to the element.	<ul style="list-style-type: none"> • Reposition the rack to provide proper clearance between the meat and the element. Preheat the broil element for searing.
	The meat has not been properly prepared.	<ul style="list-style-type: none"> • Remove the excess fat from the meat. Cut away fatty edges that may curl, leaving the lean intact.
	Grease has built up on oven surfaces.	<ul style="list-style-type: none"> • Regular cleaning is necessary when broiling frequently.





PROBLEM	POSSIBLE CAUSE	SOLUTION
Food does not bake or roast properly.	The oven controls have not been set correctly.	<ul style="list-style-type: none"> See the chapter on operating the oven.
	The oven rack has been positioned incorrectly or is not level.	<ul style="list-style-type: none"> See the section on using the oven racks on page 37.
	Incorrect cookware or cookware of improper size being used.	
	The oven sensor needs to be adjusted.	<ul style="list-style-type: none"> See the section on adjusting the thermostat on page 52.
Food does not broil properly.	The oven controls have been set incorrectly.	<ul style="list-style-type: none"> Press the BROIL pad.
	The rack has not been properly positioned.	<ul style="list-style-type: none"> See the broiling guide on page 46.
	Cookware not suited for broiling.	<ul style="list-style-type: none"> Use suitable cookware.
	In some areas the power (voltage) may be low.	<ul style="list-style-type: none"> Preheat the broil element for 10 minutes. See the broiling guide on page 46.
The oven temperature is too hot or too cold.	The oven sensor needs to be adjusted.	<ul style="list-style-type: none"> See the section on adjusting the thermostat on page 52.
Scratches or abrasions on cooktop surface.	The cooktop is being cleaned improperly.	<ul style="list-style-type: none"> Scratches are not removable. Tiny scratches will become less visible in time as a result of cleaning.
	Cookware with rough bottoms were used on the cooktop or there were coarse particles (eg. salt or sand) present between the cookware and the surface of the cooktop.	<ul style="list-style-type: none"> To avoid scratches, use the recommended cleaning procedures. Make sure cookware bottoms are clean before use, and use cookware with smooth bottoms.
	Cookware has been slid across the cooktop surface.	
Brown streaks or specks.	Boilovers have been cooked onto the surface.	<ul style="list-style-type: none"> Use the blade scraper to remove soil. See the section on care and cleaning of the glass cooktop on page 61.
Areas of discoloration with metallic sheen.	Mineral deposits from water and food have been left on the surface of the cooktop.	<ul style="list-style-type: none"> Remove using a ceramic-glass cooktop cleaning cream. Use cookware with clean, dry bottoms.
The oven will not self-clean.	The oven temperature is too high to set a self-clean operation.	<ul style="list-style-type: none"> Allow the range to cool and reset the controls.
	The oven controls have been set incorrectly.	<ul style="list-style-type: none"> See the section on self-cleaning on page 56.
	A self-cleaning cycle cannot be started if the oven lockout feature has been activated or if a induction surface element is on.	
“Crackling” or “popping” sound.	This is the sound of the metal heating and cooling during both the cooking and cleaning functions.	<ul style="list-style-type: none"> This is normal.
Excessive smoking during a self-cleaning cycle.	There is excessive soiling in the oven.	<ul style="list-style-type: none"> Press the CLEAR/OFF pad. Open the windows to rid the room of smoke. Wait until the self-cleaning cycle is cancelled. Wipe up the excessive soil and reset the oven for self-cleaning.





PROBLEM	POSSIBLE CAUSE	SOLUTION
The oven door will not open after a self-cleaning cycle.	The oven is too hot.	<ul style="list-style-type: none"> Allow the oven to cool.
Oven not clean after a self-cleaning cycle.	The oven controls were not set correctly.	<ul style="list-style-type: none"> See the section on self-cleaning on page 56.
	The oven was heavily soiled.	<ul style="list-style-type: none"> Wipe up heavy spillovers before starting the self-cleaning cycle. Heavily soiled ovens may need to self-clean again or for a longer period of time.
Steam from the vent.	When using the convection feature, it is normal to see steam coming out of the oven vent.	<ul style="list-style-type: none"> This is normal.
	As the number of racks or amount of food being cooked increases, the amount of visible steam will increase.	
Burning or oily odor emitting from the vent.	This is normal in a new oven and will disappear in time.	<ul style="list-style-type: none"> To speed the process, set a self-cleaning cycle for a minimum of 3 hours. See the section on self-cleaning on page 56.
Strong odor.	An odor from the insulation around the inside of the oven is normal for the first few times the oven is used.	<ul style="list-style-type: none"> This is temporary.
Fan noise.	A convection fan may automatically turn on and off.	<ul style="list-style-type: none"> This is normal.
Oven racks are difficult to slide.	The shiny, silver-colored racks were cleaned in a self-cleaning cycle.	<ul style="list-style-type: none"> Apply a small amount of vegetable oil to a paper towel and wipe the edges of the oven racks with the paper towel.
Display goes blank.	A fuse in your home may be blown or the circuit breaker tripped.	<ul style="list-style-type: none"> Replace the fuse or reset the circuit breaker.
Display flashes.	There was a power failure.	<ul style="list-style-type: none"> Reset the clock.
Drawer does not slide smoothly or drags.	The drawer is out of alignment.	<ul style="list-style-type: none"> Fully extend the drawer and push it all the way in. See the page 64.
	The drawer is over-loaded or the load is unbalanced.	<ul style="list-style-type: none"> Reduce weight. Redistribute drawer contents.
Warming drawer will not work.	A fuse in your home may be blown or the circuit breaker tripped.	<ul style="list-style-type: none"> Replace the fuse or reset the circuit breaker.
	The controls are not set correctly.	<ul style="list-style-type: none"> See the chapter on using the Warming drawer on page 32.
Excessive condensation in the drawer.	There is liquid present in the drawer.	<ul style="list-style-type: none"> Remove the liquid.
	Uncovered foods.	<ul style="list-style-type: none"> Cover food with a lid.
	The temperature is set too high.	<ul style="list-style-type: none"> Adjust the temperature to a lower setting.
Food dries out in the Warming drawer.	Moisture is escaping.	<ul style="list-style-type: none"> Cover food with a lid.
	The drawer is not fully closed.	<ul style="list-style-type: none"> Push the drawer in until the latch engages.



warranty

PLEASE DO NOT DISCARD THIS REPLACES THE WARRANTY PAGE IN THE USE & CARE GUIDE

SAMSUNG ELECTRIC RANGE

LIMITED WARRANTY TO ORIGINAL PURCHASER

This SAMSUNG brand product, as supplied and distributed by SAMSUNG ELECTRONICS AMERICA, INC. (SAMSUNG) and delivered new, in the original carton to the original consumer purchaser, is warranted by SAMSUNG against manufacturing defects in materials and workmanship for a limited warranty period of:

One (1) Year Parts and Labor, Five (5) Years Parts Warranty For Glass Cooktop

During this limited additional four-year warranty, you will responsible for any labor or in-home service.

This limited warranty begins on the original date of purchase, and is valid only on products purchased and used in the United States. To receive warranty service, the purchaser must contact SAMSUNG for problem determination and service procedures. Warranty service can only be performed by a SAMSUNG authorized service center. The original dated bill of sale must be presented upon request as proof of purchase to SAMSUNG or SAMSUNG's authorized service center. Samsung will provide in-home service during the warranty period at no charge subject to availability within the contiguous United States. In home service is not available in all areas. To receive in home service product must be unobstructed and accessible to the service agent. If service is not available Samsung may elect to provide transportation of the product to and from an authorized service center.

SAMSUNG will repair or replace this product, at our option and at no charge as stipulated herein, with new or reconditioned parts or products if found to be defective during the limited warranty period specified above. All replaced parts and products become the property of SAMSUNG and must be returned to SAMSUNG. Replacement parts and products assume the remaining original warranty, or ninety (90) days, whichever is longer.

This limited warranty covers manufacturing defects in materials and workmanship encountered in normal, noncommercial use of this product and shall not apply to the following: damage which occurs in shipment; delivery and installation; applications and uses for which this product was not intended; altered product or serial numbers; cosmetic damage or exterior finish; accidents, abuse, neglect, fire, water, lightning or other acts of nature; use of products, equipment, systems, utilities, services, parts, supplies, accessories, applications, installations, repairs, external wiring or connectors not supplied or authorized by SAMSUNG which damage this product or result in service problems; incorrect electrical line voltage, fluctuations and surges; customer adjustments and failure to follow operating instructions, maintenance and environmental instructions that are covered and prescribed in the instruction book; product removal and reinstallation; problems caused by pest infestations, and overheating or overcooking by user. This limited warranty shall not cover cases of incorrect electric current, voltage or supply, light bulbs, house fuses, house wiring, cost of a service call for instructions, or fixing installation errors. Furthermore, damage to the glass cooktop caused by the use of cleaners other than the recommended cleaners and pads, damage to the glass cook top caused by hardened spills of sugary materials or melted plastic that are not cleaned according to the directions in the use and care guide are not covered. SAMSUNG does not warrant uninterrupted or error-free operation of the product.

EXCEPT AS SET FORTH HEREIN THERE ARE NO WARRANTIES ON THIS PRODUCT EITHER EXPRESS OR IMPLIED AND SAMSUNG DISCLAIMS ALL WARRANTIES INCLUDING, BUT NOT LIMITED TO, ANY IMPLIED WARRANTIES OF MERCHANTABILITY, INFRINGEMENT OR FITNESS FOR A PARTICULAR PURPOSE. NO WARRANTY OR GUARANTY GIVEN BY ANY PERSON, FIRM OR CORPORATION WITH RESPECT TO THIS PRODUCT SHALL BE BINDING ON SAMSUNG. SAMSUNG SHALL NOT BE LIABLE FOR LOSS OF REVENUE OR PROFITS, FAILURE TO REALIZE SAVINGS OR OTHER BENEFITS, OR ANY OTHER SPECIAL, INCIDENTAL OR CONSEQUENTIAL DAMAGES CAUSED BY THE USE, MISUSE OR INABILITY TO USE THIS PRODUCT, REGARDLESS OF THE LEGAL THEORY ON WHICH THE CLAIM IS BASED, AND EVEN IF SAMSUNG HAS BEEN ADVISED OF THE POSSIBILITY OF SUCH DAMAGES. NOR SHALL RECOVERY OF ANY KIND AGAINST SAMSUNG BE GREATER IN AMOUNT THAN THE PURCHASE PRICE OF THE PRODUCT SOLD BY SAMSUNG AND CAUSING THE ALLEGED DAMAGE. WITHOUT LIMITING THE FOREGOING, PURCHASER ASSUMES ALL RISK AND LIABILITY FOR LOSS, DAMAGE OR INJURY TO PURCHASER AND PURCHASER'S PROPERTY AND TO OTHERS AND THEIR PROPERTY ARISING OUT OF THE USE, MISUSE OR INABILITY TO USE THIS PRODUCT. THIS LIMITED WARRANTY SHALL NOT EXTEND TO ANYONE OTHER THAN THE ORIGINAL PURCHASER OF THIS PRODUCT, IS NONTRANSFERABLE AND STATES YOUR EXCLUSIVE REMEDY.

Some provinces or territories may or may not allow limitations on how long an implied warranty lasts, or the exclusion or limitation of incidental or consequential damages, so the above limitations or exclusions may not apply to you. This warranty gives you specific legal rights, and you may also have other rights which vary from state to state. User Replaceable Parts may be sent to the customer for unit repair. If necessary, a Service Engineer can be dispatched to perform service.

To obtain warranty service, please contact SAMSUNG at:

**Samsung Electronics America, Inc.
85 Challenger Road, Ridgefield Park, NJ 07660
1-800-SAMSUNG (726-7864) and www.samsung.com**

WARRANTY



Scan the QR code* or visit
www.samsung.com/spsn
 to view our helpful
 How-to Videos and Live Shows

*Requires reader to be installed on your smartphone

Scan this with your smartphone

Please be advised that the Samsung warranty does NOT cover service calls to explain product operation, correct improper installation, or perform normal cleaning or maintenance.

QUESTIONS OR COMMENTS

COUNTRY	CALL	OR VISIT US ONLINE AT
CANADA	1-800-SAMSUNG (726-7864)	www.samsung.com/ca (English) www.samsung.com/ca_fr (French)
MEXICO	01-800-SAMSUNG (726-7864)	
U.S.A Consumer Electronics	1-800-SAMSUNG (726-7864)	www.samsung.com
U.S.A Mobile Phones	1-800-SAMSUNG (726-7864)	

DG68-00429A-04

