

# Built-In Microwave Combi Oven

---

User manual

NQ70\*\*700D\*\*

---



**SAMSUNG**

## Regulatory Notice

---

### PRECAUTIONS TO AVOID POSSIBLE EXPOSURE TO EXCESSIVE MICROWAVE ENERGY

---

- A. Do not attempt to operate this microwave oven with the door open since open-door operation can result in harmful exposure to microwave energy. It is important not to defeat or tamper with the safety interlocks.
- B. Do not place any object between the oven front face and the door or allow soil or cleaner residue to accumulate on the sealing surface.
- C. Do not operate the microwave oven if it is damaged. It is particularly important that the oven door close properly and that there is no damage to the:
  - 1) Door (bent),
  - 2) Hinges and latches, (broken or loosened),
  - 3) Door seals and sealing surface.
- D. The microwave oven should not be adjusted or repaired by anyone except properly qualified service personnel.

#### 1. FCC Notice

##### CAUTION

**FCC CAUTION:** Any changes or modifications not expressly approved by the party responsible for compliance could void the user's authority to operate the equipment.

This device complies with Part 15 of FCC Rules. Operation is Subject to following two conditions:

- 1) This device may not cause harmful interference period.
- 2) This device must accept any interference received including interference that cause undesired operation.

---

For products sold in the US and Canadian markets, only channels 1~11 are available. You cannot select any other channels.

#### FCC STATEMENT:

This equipment has been tested and found to comply within the limits for a Class B digital device, pursuant to part 15 of the FCC Rules. These limits are designed to provide reasonable protection against harmful interference in a residential installation.

This equipment generates, uses, and can radiate radio frequency energy and, if not installed and used in accordance with the instructions, may cause harmful interference to radio communications. However, there is no guarantee that interference will not occur in a particular installation.

## Regulatory Notice

---

If this equipment does cause harmful interference to radio or television reception, which can be determined by turning the equipment off and on, the user is encouraged to try to correct the interference by one or more of the following measures:

- Reorienting or relocating the receiving antenna
- Increasing the separation between the equipment and receiver
- Connecting the equipment to an outlet that is on a different circuit than the radio or TV
- Consulting the dealer or an experienced radio/TV technician for help.

### **FCC RADIATION EXPOSURE STATEMENT:**

This equipment complies with FCC radiation exposure limits set forth for an uncontrolled environment. This equipment should be installed and operated so there is at least 8 inches (20 cm) between the radiator and your body. This device and its antenna(s) must not be co-located or operated in conjunction with any other antenna or transmitter.

## **2. IC Notice**

The term “IC” before the radio certification number only signifies that Industry Canada technical specifications were met. Operation is subject to the following two conditions: (1) this device may not cause interference, and (2) this device must accept any interference, including interference that may cause undesired operation of the device.

This Class B digital apparatus complies with Canadian ICES-003. For products sold in the US and Canadian markets, only channels 1~11 are available. You cannot select any other channels.

### **IC RADIATION EXPOSURE STATEMENT:**

This equipment complies with IC RSS-102 radiation exposure limits set forth for an uncontrolled environment. This equipment should be installed and operated so there is at least 8 inches (20 cm) between the radiator and your body. This device and its antenna(s) must not be co-located or operated in conjunction with any other antenna or transmitter.

# Contents

<b>Important safety instructions</b>	<b>5</b>	<b>Oven (Lower Oven)</b>	<b>41</b>
What you need to know about safety instructions	5	Push to open door	41
California Proposition 65 Warning	6	Timed cooking	42
Grounding Instructions	7	Delay start	43
Use Of Extension Cords For Your Safety	7	Using the Temp probe	43
Electrical Safety	8	Twin cooking mode temperature setting ranges	45
Child Safety	10	Broiling recommendation guide	49
Oven	10	Air Fry	50
Self-cleaning ovens	11	Setting the mode	52
Ventilating hood	12	Setting the temperature	52
Critical installation warnings	12	Basic baking and broiling instructions	52
Critical usage warning	13	Steam Cook	55
Usage cautions	14	Air Sous Vide	56
Critical cleaning warnings	16	Convection Vegetable	58
<b>Introducing your new oven</b>	<b>19</b>	Using the special function feature	59
Overview	19	Using the smart control feature (Lower oven only)	60
What's included with your oven	19	Bixby	61
Assembling the steam container (applicable models only)	20	Amazon Alexa & Google Assistant	61
<b>Before you begin</b>	<b>21</b>	Installation Guide	61
Energy saving tips	21	Using the oven racks	62
Turntable (For microwave oven)	21	Using the gliding rack	64
Water reservoir	22	Using the divider	65
<b>Basic operations</b>	<b>23</b>	Using the clean feature	65
Control panel	23	Steam-Cleaning	68
Display	23	Settings	71
Setting the temperature	24	Using the sabbath feature	73
Control lockout	24	<b>Maintaining your appliance</b>	<b>75</b>
Kitchen timer	24	Care and cleaning of the oven	75
Minimum and maximum settings	26	Removing the oven door (Lower oven only)	77
<b>Microwave oven (Upper Oven)</b>	<b>27</b>	Replacing the oven door (Lower oven only)	78
Setting the power level	27	Changing the oven light (Lower oven only)	79
Timed cooking	27	<b>Troubleshooting</b>	<b>80</b>
Microwave	28	Control Display	80
Power Convection	29	For the Microwave Oven	80
Broil	29	For the Lower Oven	83
Speed Power Convection	30	Information codes	86
Speed Broil	30	<b>Warranty (U.S.A)</b>	<b>87</b>
Air Fry Auto Cook	31	<b>Warranty (CANADA)</b>	<b>88</b>
Healthy Cook	33	<b>Appendix</b>	<b>90</b>
Sensor Cook	35	Open Source Announcement	90
Auto Cook	38		
Defrost	40		

## Important safety instructions

Read and follow all instructions before using your oven to prevent the risk of fire, electric shock, personal injury, or damage when using the oven. This guide does not cover all possible conditions that may occur. Always contact your service agent or the manufacturer about problems that you do not understand.

### WHAT YOU NEED TO KNOW ABOUT SAFETY INSTRUCTIONS

Warnings and important safety instructions in this manual do not cover all possible conditions and situations that may occur. It is your responsibility to use common sense, caution, and care when installing, maintaining, and operating your oven.

### Important safety symbols and precautions

What the icons and signs in this user manual mean:

#### WARNING









Hazards or unsafe practices that may result in **severe personal injury or death**.

#### CAUTION

Hazards or unsafe practices that may result in **minor personal injury or property damage**.

#### CAUTION

To reduce the risk of fire, explosion, electric shock, or personal injury when using your oven, follow these basic safety precautions.

-  Do NOT attempt.
-  Do NOT disassemble.
-  Do NOT touch.
-  Follow directions explicitly.
-  Unplug the power plug from the wall socket.
-  Make sure the machine is grounded to prevent electric shock.
-  Call a Samsung service center for help.
-  Note

These warning signs are here to prevent injury to you and others. Please follow them explicitly.

After reading this section, keep it in a safe place for future reference.

## SAVE THESE INSTRUCTIONS

## Important safety instructions (Microwave Oven)

### CALIFORNIA PROPOSITION 65 WARNING

#### **⚠ WARNING**

Cancer and Reproductive Harm - [www.P65Warnings.ca.gov](http://www.P65Warnings.ca.gov).

#### **⚠ WARNING**

To reduce risk of burns, electric shock, fire, personal injury or exposure to excessive microwave energy:

1. Read all safety instructions before using the appliance.
2. Read and follow the specific "Precautions to avoid possible exposure to excessive microwave energy" on page 2.
3. This appliance must be grounded. Connect only to properly grounded outlets. See Important "Grounding instructions" on page 7 of this manual.
4. Install or locate this appliance only in accordance with the provided installation instructions.
5. Some products such as whole eggs and sealed containers (for example, closed glass jars) can explode if heated rapidly. Never heat them in a microwave oven.
6. Do not use this appliance for other purposes than cooking. Drying of clothing and heating of warming pads, slippers, sponges, damp cloth and similar may lead to risk of injury, ignition or fire. Use this appliance only for its intended use as described in the manual. Do not put corrosive chemicals or vapors in or on this appliance. This type of oven is specifically designed to heat, cook, or dry food. It is not designed for industrial or laboratory use.
7. As with any appliance, close supervision is necessary when it is used by children. Keep children away from the door when opening or closing it as they may bump themselves on the door or catch their fingers in the door.
8. Do not operate this appliance if it has a damaged cord or plug, if it is not working properly, or if it has been damaged or dropped.

9. This appliance should be repaired or serviced only by qualified service personnel. Contact the nearest authorized service facility for examination, repair, or adjustment.
10. Do not cover or block any openings in the appliance.
11. Do not tamper with or make any adjustments or repairs to the door.
12. Do not store this appliance outdoors. Do not use this product near water, for example, near a kitchen sink, in a wet basement, near a swimming pool, or similar locations.
13. Do not immerse the cord or plug in water.
14. Keep the cord away from heated surfaces (including the back of the oven).
15. Do not let the cord hang over edge of table or counter.
16. When cleaning surfaces of the door and oven that come together when the door closes, use only mild, nonabrasive soaps, or detergents applied with a sponge or soft cloth. Unplug the plug before cleaning the unit.
17. To reduce the risk of fire in the oven cavity:
  - Do not overcook food. Carefully attend appliance when paper, plastic, or other combustible materials are placed inside the oven to facilitate cooking.
  - Remove wire twist-ties from paper or plastic bags before placing the bags in the oven.
18. If materials inside the oven ignite, keep the oven door closed, turn the oven off, and disconnect the power cord, or shut off the power at the fuse or circuit breaker panel. If the door is opened, the fire may spread.
19. Do not use the cavity for storage purposes. Do not leave paper products, cooking utensils, or food in the cavity when not in use.

## SAVE THESE INSTRUCTIONS

- 
20. Liquids, such as water, milk, coffee, or tea can be overheated beyond the boiling point without appearing to be boiling. Visible bubbling or boiling when the container is removed from the microwave oven is not always present. THIS COULD RESULT IN VERY HOT LIQUIDS SUDDENLY BOILING OVER WHEN THE CONTAINER IS DISTURBED OR A SPOON OR OTHER UTENSIL IS INSERTED INTO THE LIQUID. To reduce the risk of injury:
- Do not overheat liquid.
  - Stir liquid both before and halfway through heating it.
  - Do not use straight-sided containers with narrow necks.
  - After heating, let containers with liquid stand in the microwave oven for a short time before removing.
  - Use extreme care when inserting a spoon or other utensil into a container holding liquid.
21. Oversized foods or oversized metal utensils should not be inserted into the microwave oven as they may create a fire or electric shock.
22. Do not clean with metal scouring pads. Pieces can burn off the pad and touch electrical parts creating a risk of electric shock.
23. Do not store any materials, other than manufacturer's recommended accessories, in this microwave oven when not in use.
24. Do not cover the racks or any other part of the microwave oven with metal foil. This will cause overheating of the oven.

## GROUNDING INSTRUCTIONS

---

This appliance must be grounded. In the event of an electrical short circuit, grounding reduces the risk of electric shock by providing an escape wire for the electrical current. This appliance is equipped with a cord that includes a grounding wire and a grounding plug. The plug must be plugged into an outlet that is properly installed and grounded.

## WARNING

Improper use of the grounding plug can result in a risk of electric shock.

- Plug into a grounded 3 prong outlet. Do not remove the third (grounding) prong. Do not use an adaptor or otherwise defeat the grounding plug.
- Consult a qualified electrician or service person if you do not understand the grounding instructions or if you are not sure if the appliance is properly grounded.
- We do not recommend using an extension cord with this appliance. If the power-supply cord is too short, have a qualified electrician or serviceman install an outlet near the appliance. However, if it is necessary to use an extension cord, read and follow the "Use of Extension Cords" section below.

## USE OF EXTENSION CORDS

---

A short power-supply cord is provided to reduce the risk of your becoming entangled in or tripping over a longer cord. Longer cord sets or extension cords are available and you can use them if you exercise care. If you use a long cord or extension cord:

1. The marked electrical rating of the cord set or extension cord should be at least as great as the electrical rating of the appliance.
2. The extension cord must be a grounding-type 3-wire cord and it must be plugged into a 3-slot outlet.
3. The longer cord should be arranged so that it will not drape over the counter top or tabletop where it can be pulled on by children or tripped over accidentally. If you use an extension cord, the interior light may flicker and the speed of the blower may vary when the microwave oven is on. Cooking times may be longer too.

# SAVE THESE INSTRUCTIONS

## Important safety instructions (Oven)

---

### FOR YOUR SAFETY

---

When using electrical appliances, you should follow basic safety precautions, including the following:

#### CAUTION

- Use this appliance only for its intended purpose as described in this Owner's Manual.
- Potentially hot surfaces include the oven vent opening, surfaces near the opening, and crevices around the oven door.

 **Proper Installation** - Be sure your appliance is properly installed and grounded by a qualified technician.

 **User servicing** - Do not repair or replace any part of the appliance unless specifically recommended in this manual. All other servicing should be referred to a qualified technician.

 Always disconnect the power to the appliance before servicing by removing the fuse or switching off the circuit breaker.

-  • **Do not enter the oven.**
- **Do not leave children alone.** Never leave children alone or unattended in an area where this appliance is in use. They should never be allowed to sit or stand on any part of the appliance.
- **Never use your appliance for warming or heating the room.**
- **Do not use water on grease fires.** Turn off the oven to avoid spreading the flames. Smother the fire or flames by closing the door or use a dry chemical, baking soda, or foam-type extinguisher.
- Avoid scratching or striking the glass doors and the control panel. Doing so may lead to glass breakage. Do not cook on a product with broken glass. Shock, fire, or cuts may occur.

## SAVE THESE INSTRUCTIONS



- 
- ☒ • If there is a fire in the oven during self-cleaning, turn the oven off and wait for the fire to go out. Do not force the door open. The introduction of fresh air at self-cleaning temperatures may lead to a burst of flame from the oven. Failure to follow these instructions may result in severe burns.
  - If the oven is heavily soiled with oil, self-clean the oven before using the oven again. Leaving the oil in place creates a risk of fire.
  - Wipe up heavy soil on the oven bottom with a paper towel or rag before self-cleaning. Self-cleaning the oven when there is heavy soil on the oven bottom requires longer cleaning cycles and produces more smoke.
  - ★ • **Storage in or on the appliance.** Do not store flammable materials in the oven or near the surface units. Be sure all packing materials are removed from the appliance before operating it. Keep plastics, clothes, and paper away from parts of the appliance that may become hot.
  - **Wear proper apparel.** Never wear loose-fitting or hanging garments while using the appliance.
- 
- ★ • **Use only dry potholders.** Placing moist or damp potholders on hot surfaces may result in burns from steam. Do not let the potholder touch hot heating elements. Do not use a towel or other bulky cloth instead of a potholder.
  - Teach children not to play with the controls or any other part of the oven.
  - For your safety, do not use high-pressure water cleaners or steam jet cleaners to clean any part of the oven.
  - If the power cord is damaged, it must be replaced by the manufacturer, its service agent, or similarly qualified persons to avoid creating a hazard.
  - The appliance is not intended for use by persons (including children) with reduced physical, sensory or mental capabilities, or lack of experience and knowledge, unless they have been given supervision or instruction concerning use of the appliance by a person responsible for their safety.

## SAVE THESE INSTRUCTIONS

## Important safety instructions (Oven)

---

### ELECTRICAL SAFETY

---

- ★ • Use only the factory installed flexible power cord to connect to the power supply. Do not use a 3rd party power supply cord kit.
- The appliance should be serviced only by qualified service personnel. Repairs carried out by unqualified individuals may cause injury or a serious malfunction. If your appliance is in need of repair, contact a Samsung authorized service center. Failure to follow these instructions may result in damage and void the warranty.
- Flush - mounted appliances may be operated only after they have been installed in cabinets and workplaces that conform to the relevant standards. This ensures that the appliances are installed in compliance with the appropriate safety standards.
- If your appliance malfunctions or if fractures, cracks, or splits appear:
  - Switch off the oven.
  - Unplug the oven from the AC wall outlet.
  - Contact your local Samsung service center.

### ⚠ WARNING

- Ensure that the appliance is switched off before replacing the lamp to avoid possibility of an electric shock.

### CHILD SAFETY

---

#### ⚠ WARNING

- This appliance is not intended for use by young children or infirm persons without the adequate supervision of a responsible adult.
- Young children should be supervised to ensure that they do not play with the appliance.
- Keep children away from the door when opening or closing it as they may bump themselves on the door or catch their fingers in the door.
- During self-cleaning, the surfaces may get hotter than usual. Keep small children away from the oven when it is in the self-cleaning mode.

#### ⚠ WARNING

Accessible parts may become hot during use. To avoid burns, young children should be kept away.

## SAVE THESE INSTRUCTIONS

---

## OVEN

---

- ☐ • **DO NOT TOUCH THE HEATING ELEMENTS OR INTERIOR SURFACES OF THE OVEN.** Heating elements may be hot even though they are dark in color. Interior surfaces of an oven become hot enough to cause burns. During and after use, do not touch or let clothing or other flammable materials contact the heating elements or interior surfaces of the oven until they have had sufficient time to cool. Other surfaces of the appliance may become hot enough to cause burns. Among these surfaces are oven vent openings and surfaces near these openings, the oven door, and the window of the oven door.
  - **Do not heat unopened food containers.** The build-up of pressure may cause the container to burst and result in injury.
  - **Do not use the oven to dry newspapers.** If overheated, newspapers can catch fire.
  - **Do not use the oven for a storage area.** Items stored in an oven can ignite.
- ★ • **Use care when opening the door.** Let hot air or steam escape before you remove food from or put food into the oven.
- **Protective liners.** Do not use aluminum foil to line the oven bottoms, except as suggested in this manual. Improper installation of these liners may result in a risk of electric shock or fire.
- **Placement of oven racks.** Always place oven racks in the desired location while the oven is cool. If the rack must be moved while the oven is hot, use potholders. Do not let the potholders come in contact with the hot heating element in the oven.
- ☐ • Do not allow aluminum foil or a meat probe to contact the heating elements.
- **During use, the appliance becomes hot.** Care should be taken to avoid touching heating elements inside the oven.
- Do not use harsh abrasive cleaners or sharp metal scrapers to clean the oven door glass. They can scratch the surface which may result in the glass shattering.

**SAVE THESE INSTRUCTIONS**

## Important safety instructions (Oven)

---



### CAUTION

#### **Do not attempt to operate the oven during a power failure.**

If the power fails, always turn the oven off. If the oven is not turned off and the power returns, the oven may begin to operate again. Food left unattended could catch fire or spoil.

### **SELF-CLEANING OVENS**

---

-  **Do not clean the door gasket.** The door gasket is essential for a good seal. Care should be taken not to rub, damage, or move the gasket.
- 
  - **Never keep pet birds in the kitchen.** Birds are extremely sensitive to the fumes released during an oven self-clean cycle. Fumes may be harmful or fatal to birds. Move birds to a well-ventilated room.
  - **Clean only the parts listed in this manual in the self-clean cycle.** Before self-cleaning the oven, remove the partition, rack, utensils, and any food.
  - Before operating the self-clean cycle, wipe grease and food soils from the oven. Excessive amounts of grease may ignite, leading to smoke damage to your home.

- 
  - Do not use any commercial oven cleaner or oven liner protective coating of any kind in or on the outside of the oven.
    - Remove the nickel oven shelves from the oven before you begin the self-cleaning cycle or they may discolor.
    - If the self-cleaning mode malfunctions, turn the oven off and disconnect the power supply. Have it serviced by a qualified technician.
    - Excess spillage must be removed before you run the self-cleaning cycle.

### **VENTILATING HOOD**

---

- 
  - **Clean ventilating hoods frequently.** Do not let grease accumulate on the hood or filter.
  - **When flaming foods under the hood, turn the fan on.**





## SAVE THESE INSTRUCTIONS

---

## CRITICAL INSTALLATION WARNINGS

---

### WARNING

-  • This appliance must be installed by a qualified technician or service company.
    - Failing to have a qualified technician install the oven may result in an electric shock, fire, explosion, problems with the product, or injury.
  - Unpack the oven, remove all packaging material and examine the oven for any damage such as dents on the interior or exterior of the oven, broken door latches, cracks in the door, or a door that is not lined up correctly. If there is any damage, do not operate the oven and notify your dealer immediately.
  - Keep all packaging materials out of the reach of children.
  -  • This appliance must be properly grounded.
  - Do not ground the appliance to a gas pipe, plastic water pipe, or telephone line.
    - This may result in electric shock, fire, an explosion, or problems with the product
- 
-  • Do not cut or remove the ground prong from the power cord under any circumstances.
  - Connect the oven to a circuit that provides the correct amperage.
  -  • Do not install this appliance in a humid, oily or dusty location, or in a location exposed to direct sunlight or water (rain drops).
    - This may result in electric shock or fire.
  - Do not use a damaged power cord or loose wall socket.
    - This may result in electric shock or fire.
  - Do not pull or excessively bend the power cord.
  - Do not twist or tie the power cord.
  - Do not hook the power cord over a metal object, place a heavy object on the power cord, or insert the power cord between objects.
    - This may result in electric shock or fire.
  -  If the power cord is damaged, contact your nearest Samsung service center.

## SAVE THESE INSTRUCTIONS

## Important safety instructions (Oven)



---

### CRITICAL USAGE WARNING

---

#### CAUTION

-  • If the appliance is flooded by any liquid, please contact your nearest Samsung service center. Failing to do so may result in electric shock or fire.
- If the appliance produces a strange noise, a burning smell, or smoke, unplug the power plug immediately and contact your nearest Samsung service center.
  - Failing to do so may result in electric shock or fire
- In the event of a gas leak (such as propane gas, LP gas, etc.), ventilate the area immediately. Do not touch the power cord. Do not touch the appliance.
  - A spark may result in an explosion or fire.
- Be careful not to contact the oven door, heating elements, or any of the other hot parts with your body while cooking or just after cooking.
  - Failing to do so may result in burns.
- If materials inside the oven should ignite, keep the oven door closed, turn the oven off and disconnect the power cord, or shut off power at the fuse or circuit breaker panel. If the door is opened, the fire may spread.

-  • Always observe safety precautions when using your oven. Never try to repair the oven on your own - there is dangerous voltage inside. If the oven needs to be repaired, contact an authorized Samsung service center near you.
- If you use the appliance when it is contaminated by foreign substances such as food waste, it may result in a problem with the appliance.
- Use caution when removing the wrap around the food taken out of the appliance.
  - If the food is hot, hot steam may be emitted abruptly when you remove the wrapping and this may result in burns.
-  • Do not attempt to repair, disassemble, or modify the appliance yourself.
  - Since a high voltage current enters the product chassis, it may result in electric shock or fire.
  - When a repair is needed, contact your nearest Samsung service center.
-  • If any foreign substance such as water has entered the appliance, contact your nearest Samsung service center.
  - Failing to do so may result in electric shock or fire.

## SAVE THESE INSTRUCTIONS

- 
- ☒ • Do not touch the power cord with wet hands.
    - This may result in electric shock.
  - Do not turn the appliance off while an operation is in progress.
    - This may cause a spark and result in electric shock or fire.
  - Do not let children or any person with reduced physical, sensory, or mental capabilities use this appliance unsupervised.
  - Make sure that the appliance's controls and cooking areas are out of the reach of children.
    - Failing to do so may result in electric shock, burns, or injury.
  - Do not touch the inside of the appliance immediately after cooking. The inside of the appliance will be hot.
    - Failing to do so may result in burns.
  - Do not use or place flammable sprays or objects near the oven.
    - Flammable items or sprays can cause fire or an explosion.

- 
- ☒ • Do not insert fingers, foreign substances, or metal objects such as pins or needles into inlets, outlets, or holes. If foreign substances are inserted into any of these holes, contact your product provider or nearest Samsung service center.
  - Do not tamper with or make any adjustments or repairs to the door. Under no circumstances should you remove the door or outer shell of the oven.
  - Do not store or use the oven outdoors.
  - Never use this appliance for purposes other than cooking.
    - Using the appliance for any purpose other than cooking may result in fire.
  - Open the cap or stopper of sealed containers (herb tonic tea bottle, baby bottle, milk bottle and so on) before heating them. Make a hole in food items that have shells (eggs, chestnuts, etc) with a knife before cooking them.
    - Failing to do so may result in burns or injury.
  - Never heat plastic or paper containers and do not use them for cooking.
    - Failing to do so may result in fire.

**SAVE THESE INSTRUCTIONS**

## Important safety instructions (Oven)

---

- ☐ • Do not heat food wrapped in paper from magazines, newspapers, etc.
  - This may result in fire.
- Do not open the door when the food in the oven is burning.
  - If you open the door, it causes an inflow of oxygen and may cause the food to ignite.
- Do not apply excessive pressure to the door or the inside of the appliance. Do not strike the door or the inside or the appliance.
  - Hanging on to the door may result in the product falling and cause serious injury.
  - If the door is damaged, do not use the appliance. Contact a Samsung service center.
- Do not hold food in your bare hands during or immediately after cooking.
  - Use cooking gloves. The food may be very hot and you could burn yourself.
  - As the handle and oven surfaces may be hot enough to cause burns after cooking, use cooking gloves to protect your hands from burns.

## USAGE CAUTIONS

---

### ⚠ CAUTION

- ★ • If the surface is cracked, turn the appliance off.
  - Failing to do so may result in electric shock.
- Dishes and containers can become hot. Handle with care.
- Hot foods and steam can cause burns. Carefully remove container coverings, directing the steam away your hands and face.
- Remove lids from baby food jars before heating. After heating baby food, stir well to distribute the heat evenly. Always test the temperature by tasting before feeding the baby. The glass jar or the surface of the food may appear to be cooler than the interior, which can be hot enough to burn an infant's mouth.
- Beverages or food may be very hot after heating.
  - Especially when feeding a child, make sure the food or beverage has cooled sufficiently.

## SAVE THESE INSTRUCTIONS



- 
- ★ • Use caution when heating liquids such as water or other beverages.
    - Make sure to stir during or after cooking.
    - Avoid using a slippery container with a narrow neck.
    - Wait at least 30 seconds after heating before removing the heated liquid.
    - Failing to do so may result in an abrupt overflow of the contents and cause burns.
  - ☐ • Do not stand on top of the appliance or place objects (such as laundry, an oven cover, lighted candles, lighted cigarettes, dishes, chemicals, metal objects, etc.) on the appliance.
    - Items, such as a cloth, may get caught in the door.
    - This may result in electric shock, fire, problems with the product, or injury.
  - Do not operate the appliance with wet hands.
    - This may result in electric shock.
  - Do not spray volatile substances such as insecticide onto the surface of the appliance.
    - These substances are not only harmful, but may also result in electric shock, fire, or problems with the product.
- 
- ☐ • Do not put your face or body close to the appliance while cooking or when opening the door just after cooking.
    - Do not let children come too close to the appliance.
    - Failing to do so may result in a burn.
  - Do not place food or heavy objects over the edge of the oven door.
    - If you open the door, the food or object may fall and this may result in burns or injury.
  - Do not abruptly cool the door, the inside of the appliance, or the dish by pouring water over it during or just after cooking.
    - This may result in damage to the appliance. The steam or water spray may result in burns or injury.
  - Do not operate while empty except for self-cleaning.
  - Do not defrost frozen beverages in narrow-necked bottles as bottles can break.
  - Do not scratch the glass of the oven door with a sharp object.
    - This may result in the glass being damaged or broken.
  - Do not store anything directly on top of the appliance when it is in operation.

**SAVE THESE INSTRUCTIONS**

## Important safety instructions (Oven)

---

- ☒ • Do not use sealed containers. Remove seals and lids before cooking. Sealed containers can explode due to the build up of pressure even after the oven has been turned off.
- Make sure the food you are cooking in the oven does not come into contact with the heating element.
  - This may result in fire.
- Do not over-heat food.
  - Overheating food may result in fire.
- Use caution when opening or closing the door. Your fingers may be pinched, resulting in physical injury.
- The door has wires at the bottom for connecting LED lights. Be careful not to pull or cut the wires when handling the door.

## CRITICAL CLEANING WARNINGS

---

### ⚠ CAUTION

- ★ • Do not clean the appliance by spraying water directly on to it.
- Do not use benzene, thinner, or alcohol to clean the appliance.
  - This may result in discoloration, deformation, damage, electric shock, or fire.
- Be cautious not to hurt yourself when cleaning the appliance (externally or internally).
  - You may hurt yourself on the sharp edges of the appliance.
- Do not clean the appliance with a steam cleaner.
  - This may result in corrosion.
- Keep the inside of the oven clean. Food particles or spattered oils stuck to the oven walls or floor can cause paint damage and reduce the efficiency of the oven.

**SAVE THESE INSTRUCTIONS**

# Introducing your new oven

## Overview

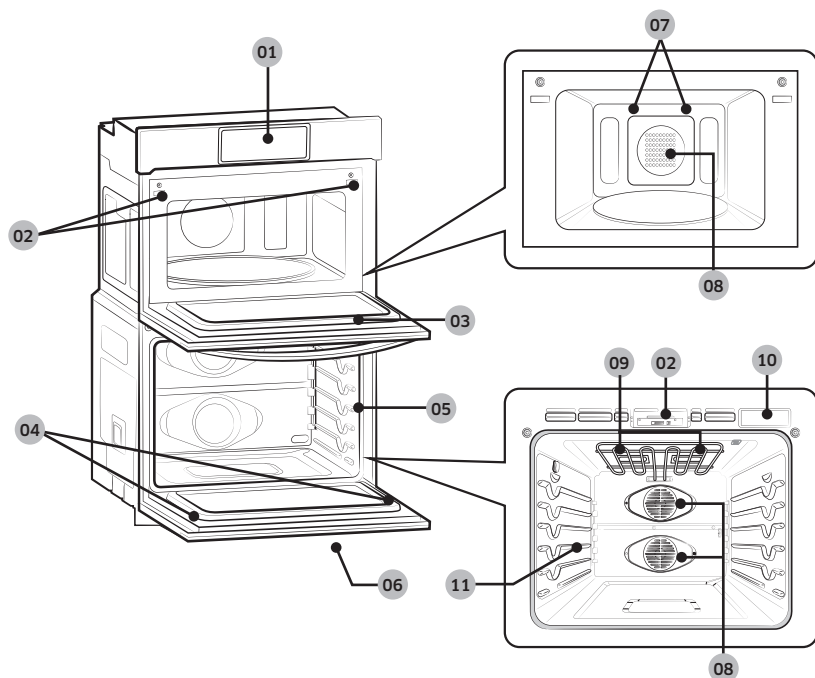

- |                           |                          |                          |
|---------------------------|--------------------------|--------------------------|
| <b>01</b> Control panel   | <b>02</b> Door latch     | <b>03</b> MWO door       |
| <b>04</b> Door LED light  | <b>05</b> Oven gasket    | <b>06</b> Oven door      |
| <b>07</b> LED lamp        | <b>08</b> Convection fan | <b>09</b> Halogen lamp * |
| <b>10</b> Water reservoir | <b>11</b> Shelf position |                          |

### NOTE

If you need an accessory marked with a \*, you can purchase by calling the Samsung Contact Center (1-800-726-7864) or visit our website([www.samsung.com/us/support](http://www.samsung.com/us/support)).

## What's included with your oven

This oven ships with different kinds of accessories that help you cook what you want.

### Accessories for oven

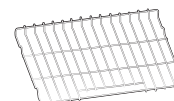

Wire rack (1)\*

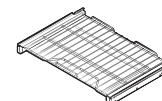

Gliding rack (1)\*

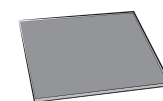

Divider (1)\*



Temp probe (1)\*

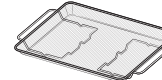

Air Fry tray (1)\*

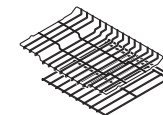

Wire Rack Steam (1)\*

Wire racks	Use these racks in the lower oven when baking and broiling.
Gliding rack	The fully extendable Gliding Rack makes food preparation easier, especially when you are preparing heavier dishes.
Divider	Use the Divider to divide the lower oven into two cavities so you can cook two different items at the same time.
Temp probe	The Temp probe lets you cook meat to the exact internal temperature you want, taking the guess work out of determining whether a piece of meat is done or not.
Air Fry tray	Use this rack in the oven when using Air Fry mode.
Wire rack steam	Use this rack in the oven when using Steam Bake, Steam Roast or Steam Cook mode.

# Introducing your new oven

## Accessories for microwave

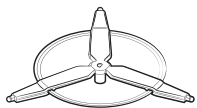

Roller ring\*

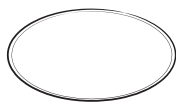

Turntable\*



Hot plate\*

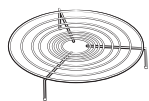

Low rack\*

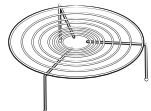

High rack\*

Roller ring	Put in the center of the base. It supports the turntable.
Turntable	Put on the roller ring with the center fitting of the coupler. It serves as a cooking base.
Racks	Use one of these racks as appropriate to cook two dishes simultaneously. A smaller dish on the turntable, and the other on the selected rack. You can use these racks with Broil or Convection function.  <b>NOTE</b> Do not use wire racks with Microwave mode except where specifically noted in this manual.
Hot plate	Put on the turntable. Use this to brown food, or to keep pastries or pizza crisp.

### NOTE

- Do not use the turntable without the roller ring.
- If you need an accessory marked with a \*, you can purchase by calling the Samsung Contact Center (1-800-726-7864) or visit our website([www.samsung.com/us/support](http://www.samsung.com/us/support)).

## Assembling the steam container (applicable models only)

The Steam container and glass lid are only for full steam cook function. Use the Steam container on the Wire rack steam only and make sure to insert fully into the compartment so the container touches the rear wall.

The steam container has 4 separate parts : Glass lid, metal pan, steam tray, and steam nozzle.

### WARNING

Do not use glass lid for broiling, baking. Use the Steam cook mode only.

### CAUTION

- Always wear oven gloves when handling the steam container and be careful not to drop the steam container.
- Sudden temperature changes could cause glass parts to break or shatter.

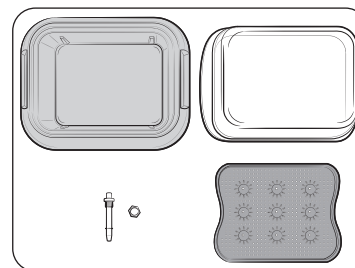

- Check and make sure you have all the parts for the steam container.

- Parts include glass lid, metal pan, steam tray, and steam nozzle.

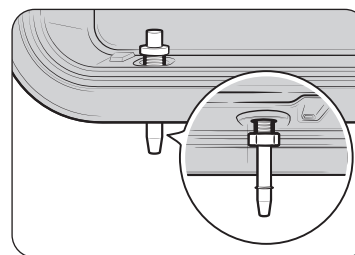

- Insert the steam nozzle into the hole on the right-rear side of the metal pan, and then tighten the provided nut.

## Before you begin

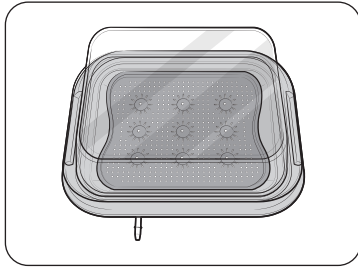

3. Put the steam tray in the metal pan, and then close the glass lid to use it in the oven.

### NOTE

If you need a steam container, you can buy it from the Samsung Contact Center (1-800-726-7864) or visit our website([www.samsung.com/us/support](http://www.samsung.com/us/support)).

Before using the top and bottom ovens for the first time, remove all the accessories, and then clean the ovens thoroughly. Then, set the lower oven to Bake, and run it at 400 °F for 1 hour. Next, set the microwave (top) oven to Power Convection, and then run it at 400 °F for 1 hour. There will be a distinctive odor. This is normal.

Ensure your kitchen is well ventilated during this conditioning period.

### Energy saving tips

- During cooking, the oven door should remain closed except when you turn food over. Do not open the door frequently during cooking to maintain the oven temperature and to save energy.
- If cooking time is more than 30 minutes, you can switch the oven off 5-10 minutes before the end of the cooking time to save energy. The residual heat will complete the cooking process.
- To save energy and reduce the time needed for re-heating the oven, plan oven use to avoid turning the oven off between cooking one item and the next.
- Whenever possible, cook more than one item at a time.

### Turntable (For microwave oven)

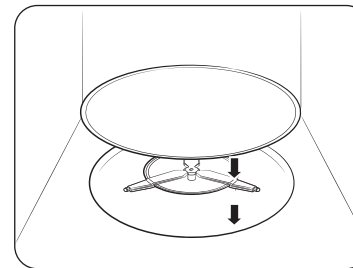

Remove all packing materials inside the oven. Install the roller ring and turntable. Check that the turntable rotates freely.

# Before you begin

## Water reservoir

The water reservoir is used for the Steam Bake, Steam Roast, Steam Proof and Steam Cook functions and also to remove water scale that may form on the oven walls, especially after Steam Baking, Steam Roasting, Steam Proofing and Steam Cooking. Fill it with water before steam cooking or descaling.

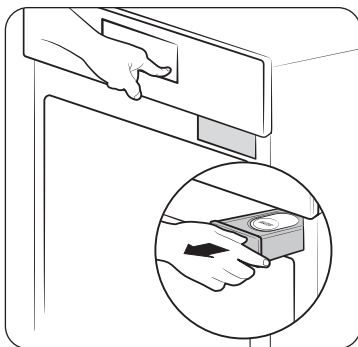

1. Locate the water reservoir. The water reservoir is on the right side of the oven, just above the oven opening. Touch **Open/Close Reservoir** on the control panel to eject the water reservoir. Grab the front of the reservoir, and then slide it out to remove.

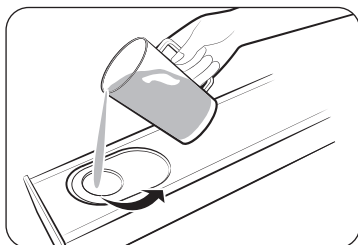

2. Open the reservoir cap, and then fill the reservoir with 22 oz. (650 ml) of drinkable water.

### NOTE

You can open the reservoir by removing the rubber cap or by removing the clear plastic top.

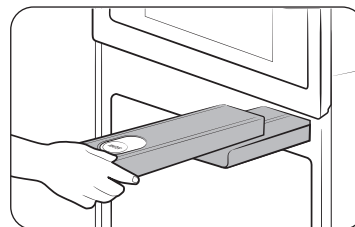

3. Replace the cap or the clear plastic top, and then slide the water reservoir back into the reservoir slot.
4. Push the reservoir in. There will be soft click when it is in place correctly. Touch **Open/Close Reservoir**. The oven retracts the water reservoir.
5. Close the oven door.

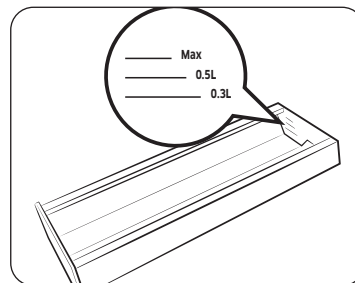

### NOTE

Do not exceed the max line.

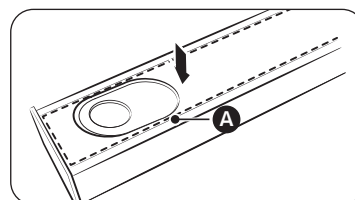

### NOTE

Make sure the cap and the upper portion of the water reservoir (**labeled A**) are closed before using the oven.

### CAUTION

The water reservoir becomes hot during cooking. Make sure you wear oven gloves to remove or refill the water reservoir.

# Basic operations

## Control panel

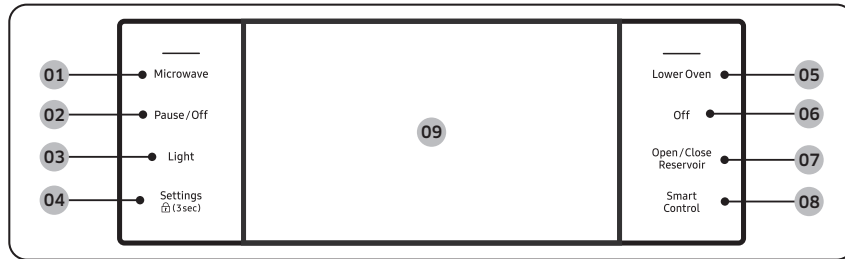

- 01 Microwave** : Use to display the upper Microwave oven mode screen on the display. Touching here does not turn the oven on or off. It only displays its current status.
- 02 Pause/Off** : Use to pause or turn off the upper Microwave oven's operation.
- 03 Light** : Use to turn the oven light on or off.
- 04 Settings** (3sec) : Use to display the Setting screen. If you touch and hold this key for 3 seconds, all oven functions will be disabled.
- 05 Lower Oven** : Use to display the lower oven mode screen on the display. Touching here does not turn the oven on or off. It only displays its current status.
- 06 Off** : Use to turn off the lower oven's operation.
- 07 Open/Close Reservoir** : Touch to open the water reservoir.
- 08 Smart Control** : Use to turn the Smart Control function on or off.
- 09 Display** : Swipe to navigate through the menus and tap to select a desired setting.

### NOTE

If you tap the display while wearing plastic or oven gloves, the display will not operate properly. Take the gloves off first, and then tap with a bare finger.

## Display

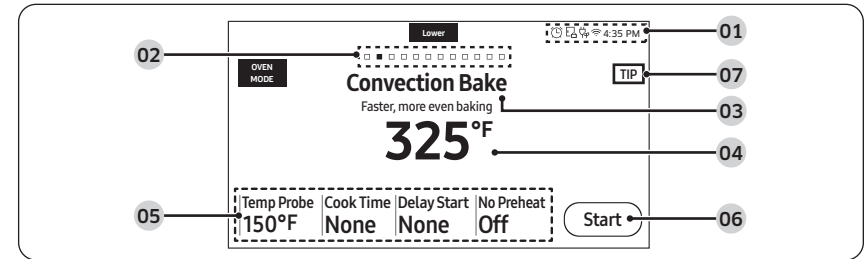

- 01 Indicator area**
  - **Timer** (🕒): When the timer is set, the **Timer** indicator is displayed.
  - **Door lock** (🔒): Displayed when the oven door is locked.
  - **Wi-Fi** (📶): Shows **Wi-Fi** signal strength in 5 steps. When **Wi-Fi** is disconnected, 📶 is shown.
  - **12-hour energy saving** (🔌): Displayed when **12-hour energy saving** is turned on.
  - **Current time** : The **Current time** is displayed.
- 02 Page indicator** : Shows location of current mode.
- 03 Mode** : The current or selected menu is displayed with a **Mode** description.
- 04 Temperature** : The current or selected temperature is displayed. When you tap this area, the **Temperature** adjustment screen is displayed.
- 05 Information area**
  - **Temp Probe** : The set temperature of the temp probe is displayed. When you tap this area, the **Temp Probe** screen is displayed.
  - **Cook Time** : The cooking time is displayed. When you tap this area, the cooking time screen is displayed.
  - **Delay Start** : The delay start time is displayed. When you tap this area, the **Delay Start** screen is displayed.
  - **No Preheat** : Indicates if the **No Preheat** feature is on or off. (Only displayed when you are using the Convection Bake or Convection Roast mode.)
  - **Steam** : The steam level is displayed. When you tap this area, the **Steam** level screen is displayed. (Only displayed when you are using the Steam Bake or Steam Roast mode.)
- 06 Start** : Tap to start the oven using the displayed settings.
- 07 TIP** : Tap to show popup guide about temp. (Only displayed when you are using the convection bake or convection roast mode.)

# Basic operations

## Setting the temperature

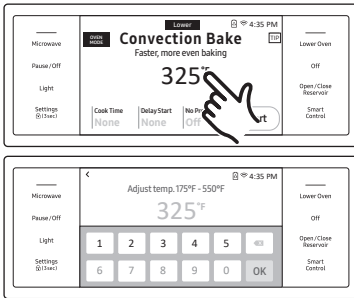

- Tap the temperature area to display the numeric pad.
- Tap the numbers in the numeric pad to set the temperature.
- Tap **OK**.

## Control lockout

Control lockout lets you lock the buttons on the touch pad so they cannot be activated accidentally. Control Lock locks only the lower oven door so it cannot be opened. You can only activate Control Lockout when the oven is in standby mode.

### How to activate the control lockout feature

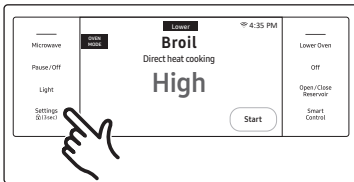

1. Cancel or turn off all functions.
2. Touch **Settings** (padlock icon) (3sec) for 3 seconds.

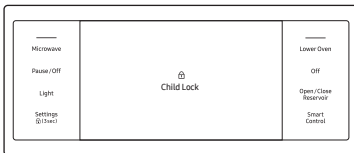

3. The display will change to the control lock screen and the control lock confirmation will appear at the bottom of the screen.

### NOTE

- Control Lockout is available only when the oven temperature is under 400 °F.
- All other functions must be cancelled before you activate Control Lockout.

### How to unlock the controls

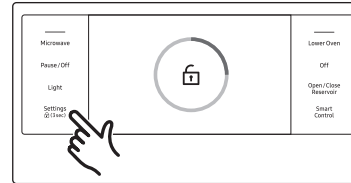

Touch **Settings** (padlock icon) (3sec) for 3 seconds. The control lock confirmation and the lock icon will disappear from the display.

### NOTE

It may take up to 10 seconds for the doors to unlock.

## Kitchen timer

The kitchen timer serves as an extra timer that will beep when the set time has elapsed. It does not start or stop cooking functions. You can use the kitchen timer with any of the other oven functions. You can set 10 timers maximum simultaneously. Each active timer will count down independently.

### How to set the timer



1. Touch **Settings**.

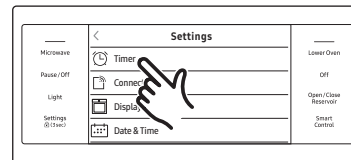

2. Touch **Timer**. The display will change to the timer screen.



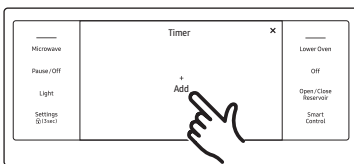

### 3. Tap + Add.

#### NOTE

After you have performed Steps 1 to 6, you can return to Step 3 and set additional timers. You can also name timers so you can identify them separately.

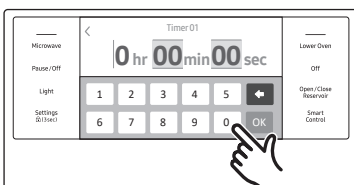

### 4. Tap the numbers in the numeric pad to set the timer. (You can set the timer for any amount of time from 1 sec to 99 hr 59 min 59 sec)

### 5. Tap **OK**.

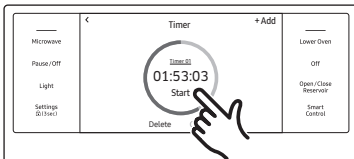

### 6. Tap **Start**.

When the set time has elapsed, the oven will beep and the display will show the Timer has finished.

- You can pause, cancel, or delete the timer at any time by tapping the screen.

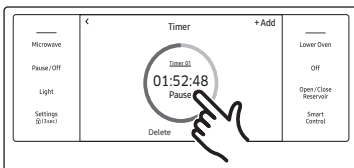

### How to change the timer name

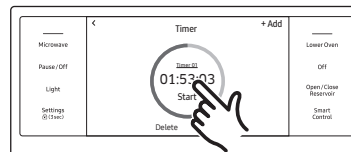

You can change the timer name to identify what you are timing, for example, a chicken defrosting.

- Tap the timer name area.
  - The keyboard appears.
- Enter the new timer name, and then tap **OK**.
  - The display shows the changed timer name.

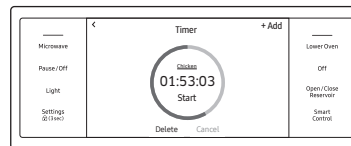

# Basic operations

## Minimum and maximum settings

### Upper microwave oven

All the features listed in the table below have minimum and maximum time, temperatures, and power level settings.

Feature		Temp./ Power range	Default Temp./ Power	Max. time
Manual mode	Microwave	10 - 100 %	100 %	1 Hr. 30 min.
		The microwave energy enables food to be cooked or reheated without changing its form or color.		
	Power Convection	100 - 450 °F (40-230 °C)	350 °F	2 Hr.
		Power Convection is similar to Convection mode. However, the heating elements generate stronger heat and distribute stronger air currents inside the oven. This is designed to cook food faster while keeping or improving the taste.		
	Broil	-	-	1 Hr. 30 min.
		Use this feature for grilling food such as meat.		
	Speed Power Conv.	100 - 450 °F (40 - 230 °C) 10 - 70 %	350 °F 30 %	1 Hr. 30 min.
		The heating elements generate heat and the convection fan distributes the heat inside the oven, which is reinforced by microwave energy.		
Speed Broil	10 - 70 %	30 %	1 Hr. 30 min.	
	The heating elements generate heat, which is reinforced by microwave energy.			

Feature		Temp./ Power range	Default Temp./ Power	Max. time
Auto mode	Air Fry Auto Cook	You will use less oil compared to frying with an oil fryer and feel much healthier as you reduce the use of oil. The oven offers 20 pre-programmed air frying recipes.		
	Healthy Cook	The Healthy Cook menu contains healthier alternative cooking items.		
	Sensor Cook	The 11 Sensor Cooking features provide preprogrammed cooking times. You do not need to set either the cooking times or the power levels.		
	Auto Cook	For cooking beginners, the oven offers various type of cooking programs including Soften & Melt.		
	Defrost	The oven offers 4 defrosting programs for your convenience.		

O = Available                      - = Not Available

\* To use the twin mode functionality of the lower oven, you must insert the divider into the lower oven and divide it into an upper and lower compartment. See page 65.

\*\* A blank means that a factory set temperature is applied for the best performance. You cannot adjust this temperature.

# Microwave oven (Upper Oven)

## Setting the power level



- Tap the **Power** area.

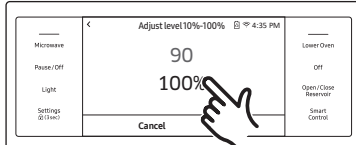

- Flick the screen to set the power level.

## Timed cooking

In timed cooking mode, the oven turns on immediately and cooks for the length of time you select.

At the end of the cooking time, the oven turns off automatically.

- You can use the timed cooking feature only with another cooking operation. (Microwave, Power Convection, Broil, Speed Power Convection, Speed Broil).

## How to set the oven for timed cooking

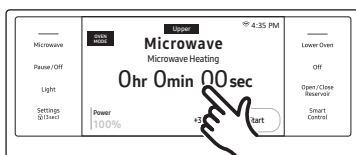

1. Select the Microwave Oven mode to select the cooking operation you want.
2. Tap Cook Time. The display will change to the cooking time screen.

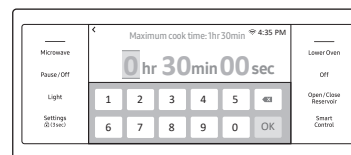

3. Tap numbers in the numeric pad to set the cooking time.



4. Tap **OK**. The cooking time screen closes.

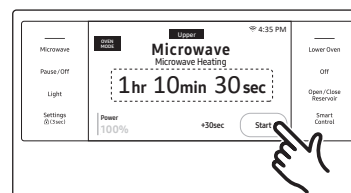

5. The cooking time is displayed in the Cook Time area on the screen.
6. Tap **Start** to start cooking.
7. If you want to pause cooking, tap **Pause**. In **Pause**, you can cancel or continue cooking by tapping **Off** or **Continue**.

## NOTE

See pages 52 through 53 for basic baking and broiling instructions.

## CAUTION

Caution when using the timed cooking features. You can use these features to cook cured or frozen meats and most fruits and vegetables. For food that can easily spoil such as milk, eggs, and unfrozen or fresh fish, meat, or poultry, chill them in the refrigerator first. Even when chilled, they should not stand in the oven for more than 1 hour before cooking begins, and should be removed promptly when cooking is completed. Eating spoiled food can result in sickness from food poisoning.

# Microwave oven (Upper Oven)

## Microwave

Microwaves are high-frequency electromagnetic waves that can be used to cook or reheat food without changing either the form or color of the food.

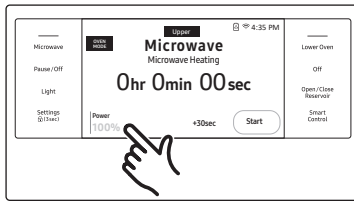

1. Put food in a microwave-safe container, and then place the container in the center of the turntable. Close the door.
2. Select the Microwave Oven mode to **Microwave**.
3. Tap **Power**, and then, flick the screen to set the power level. You can select a desired power level between 10 % and 100 % (default: 100 %).

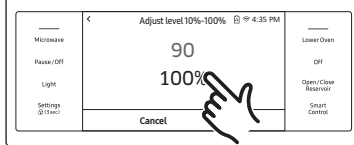

4. Tap **Cook Time**, and then use the number pad to input a desired cook time. You can also use the **+30sec** button to specify the cooking time.

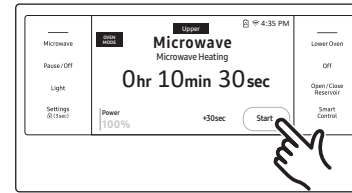
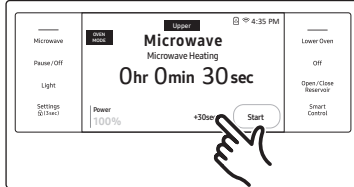
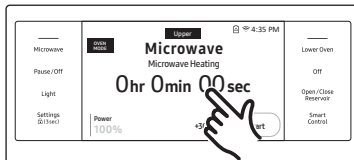

5. Tap **Start** to start cooking.
6. If you want to pause cooking, tap **Pause**. In **Pause**, you can cancel or continue cooking by tapping **Off** or **Continue**.

### ⚠ CAUTION

- Use only microwave-safe cookware.
- Use oven gloves when taking out food.

### Power level

100 %	(High)	50 %	(Medium)
90 %	(Sauté)	40 %	(Medium low)
80 %	(Reheat)	30 %	(Low)
70 %	(Medium high)	20 %	(Defrost)
60 %	(Simmer)	10 %	(Warm)

## Power Convection

The heating elements generate heat, which is evenly distributed inside the oven by the convection fan. You can use a microwave rack or a combination of a rack and hot plate on the turntable. Use this mode for biscuits, individual scones, rolls, and cakes as well as fruit cakes, choux pastries, and soufflés.

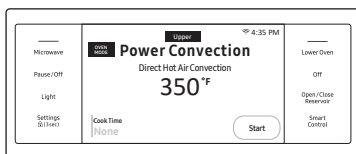

1. Put a rack or the combination of a rack and the hot plate on the turntable.
2. Select the Microwave Oven mode to **Power Convection**, and then tap the temperature area. If you tap the temperature area, the numeric pad will appear. You can input a desired temperature between 100 °F and 450 °F (default: 350 °F).



### NOTE

To preheat, simply tap **Start**.

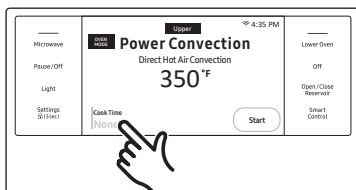

3. Tap **Cook Time**, and then use the number pad to specify a cooking time.

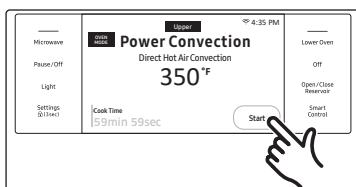

4. Tap **Start** to start cooking.
5. If you want to pause cooking, tap **Pause**. In **Pause**, you can cancel or continue cooking by tapping **Off** or **Continue**.

### CAUTION

Use oven gloves when taking out food.

## Broil

For best performance, make sure all heating elements are in a horizontal position.



1. Put a rack or the combination of a rack and the hot plate on the turntable.
2. Select the Microwave Oven mode to **Broil**. If preheating is preferred, simply tap **Start**.



### NOTE

You cannot set the temperature in **Broil** mode.



3. Tap **Cook Time**, and then use the number pad to specify a cooking time.

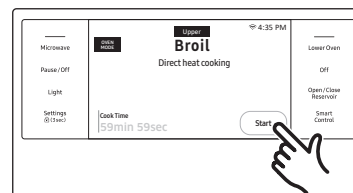

4. Tap **Start** to start cooking.
5. If you want to pause cooking, tap **Pause**. In **Pause**, you can cancel or continue cooking by tapping **Off** or **Continue**.

### CAUTION

Use oven gloves when taking out food.

# Microwave oven (Upper Oven)

## Speed Power Convection

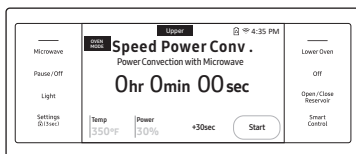

1. Put a rack or the combination of a rack and the hot plate on the turntable.
2. Select the Microwave Oven mode to **Speed Power Convection**, and then tap the temperature area. If you tap the temperature area, the numeric pad will appear. You can input a desired temperature between 100 °F and 450 °F (default: 350 °F).

### NOTE

To preheat, simply tap **Start**.



3. Tap **Power**, and then flick the screen to specify a power level between 10 % and 70 % (default: 30 %).

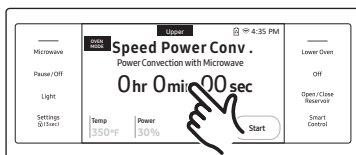

4. Tap **Cook Time**, and then use the number pad to specify a cooking time. You can also use the **+30sec** button to specify the cooking time.

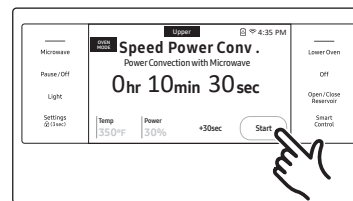

5. Tap **Start** to start cooking.
6. If you want to pause cooking, tap **Pause**. In **Pause**, you can cancel or continue cooking by tapping **Off** or **Continue**.

### CAUTION

- Use only microwave-safe cookware.
- Use oven gloves when taking out food.

## Speed Broil

The heating elements generate heat, which is reinforced by the microwave energy.



1. Put a rack or the combination of a rack and the hot plate on the turntable.
2. Select the Microwave Oven mode to **Speed Broil**.

### NOTE

You cannot set the temperature in Speed broil mode.

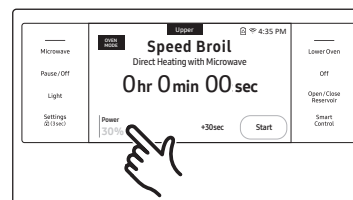

3. Tap **Power**, and then flick the screen to specify a power level between 10 % and 70 % (default: 30 %).

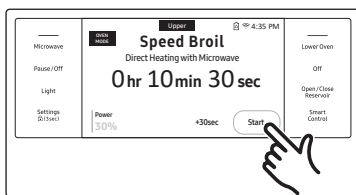
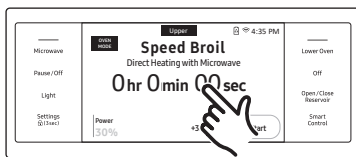

4. Tap **Cook Time**, and then use the number pad to specify a cooking time. You can also use the **+30sec** button to specify the cooking time.

5. Tap **Start** to start cooking.
6. If you want to pause cooking, tap **Pause**. In **Pause**, you can cancel or continue cooking by tapping **Off** or **Continue**.

#### ⚠ CAUTION

- Use only microwave-safe cookware.
- Use oven gloves when taking out food.

## Air Fry Auto Cook

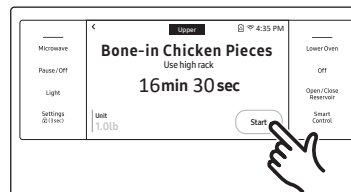
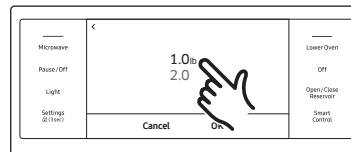
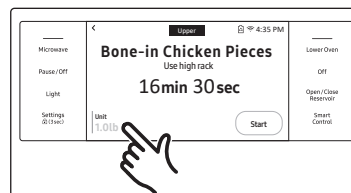

1. Put the food in the center of the turntable and close the door.
2. Select the Microwave Oven mode to **Air Fry Auto Cook**.
3. Tap to select one of 20 different options.
4. Tap the weight area to select the food weight screen.
5. Flick the screen to select the food weight.
6. Tap **Start** to start cooking.
7. If you want to pause cooking, tap **Pause**. In **Pause**, you can cancel or continue cooking by tapping **Off** or **Continue**.

#### ⚠ CAUTION

- Use only microwave-safe cookware.
- Use oven gloves when taking out food.

## Microwave oven (Upper Oven)

Food	Amount	Instructions
Bone-in Chicken Pieces	1.0 lb 2.0 lbs	Place the chicken pieces skin side down on the high rack and hot plate on the turntable to catch drips. When the oven beeps, turn over bone-in chicken pieces, and then press <b>Start</b> to continue.
Sirloin Steak, Medium (1 inch)	1.0 lb	Place the sirloin on the high rack and hot plate on the turntable to catch drips. When the oven beeps, turn over steak, and then press <b>Start</b> to continue.
Sirloin Steak, Well Done (1 inch)	1.0 lb	Place the sirloin on the high rack and hot plate on the turntable to catch drips. When the oven beeps, turn over steak, and then press <b>Start</b> to continue.
Boneless Pork Chops	2 ea 4 ea	Place the pork chops on the high rack and hot plate on the turntable to catch drips. When the oven beeps, turn over pork chops, and then press <b>Start</b> to continue.
Salmon Steaks	2 ea 4 ea	Put the salmon steaks on the high rack and hot plate on the turntable to catch drips.
Frozen Pizza (6 inch)	6 inch	Place the frozen pizza on the high rack.
Frozen Pizza (12 inch)	12 inch	Place the frozen pizza on the low rack.
Frozen Waffles	2 ea 4 ea	Place the frozen waffles on the hot plate, then place the plate on the low rack.
Frozen Mozzarella Sticks	6 ea 12 ea	Place the frozen mozzarella sticks on the hot plate, then place the plate on the high rack.
Frozen Buffalo Wings	12 oz 16 oz	Place the frozen buffalo wings on the hot plate, then place the plate on the high rack.

Food	Amount	Instructions
Frozen French Fries	12 oz 16 oz	Place the frozen french fries on the hot plate, then place the plate on the high rack.
Frozen Chicken Nuggets	8 oz 16 oz	Place the frozen chicken nuggets on the hot plate, then place the plate on the high rack.
Frozen Onion Rings	8 oz 12 oz	Place the frozen onion rings on the hot plate, then place the plate on the high rack.
Frozen Potato Croquettes	8 oz 16 oz	Place the frozen potato croquettes on the hot plate, then place the plate on the high rack.
Frozen Prawns, Breaded	8 oz 12 oz	Place the frozen breaded prawns on the hot plate, then place the plate on the high rack.
Frozen Fish Sticks	8 oz 12 oz	Place the frozen fish sticks on the hot plate, then place the plate on the high rack.
Homemade French Fries	8 oz 12 oz	Place the homemade french fries on the hot plate, then place the plate on the high rack.
Drumsticks	3 ea 6 ea	Place the chicken drumsticks on the hot plate, then place the plate on the high rack. When the oven beeps, turn over drumsticks, and then press <b>Start</b> to continue.
Chicken Wings	10 ea 20 ea	Place the chicken wings on the hot plate, then place the plate on the high rack.
Roasted Vegetables	8 oz 12 oz	Spread the vegetables on a hot plate, then place the plate on the high rack.



## Healthy Cook

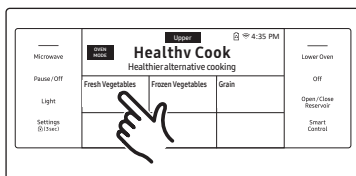

1. Put the food in the center of the turntable and close the door.
2. Select the Microwave Oven mode to **Healthy Cook**.

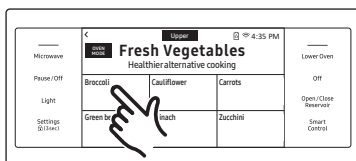

3. Tap to select **Healthy Cook**. The display will show 3 different menus. These provide 15 Healthy Cook options. (You can scroll down the list.)

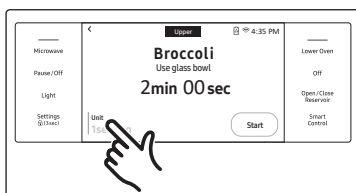

4. Tap the serving area to display the servings of food screen.

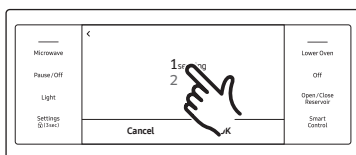

5. Flick the number to select the number of servings.
6. Tap **OK**.



7. Tap **Start** to start cooking.
8. If you want to pause cooking, tap **Pause**. In **Pause**, you can cancel or continue cooking by tapping **Off** or **Continue**.

### ⚠ CAUTION

- Use only microwave-safe cookware.
- Use oven gloves when taking out food.

Food	Amount	Instructions
<b>Fresh Vegetables</b>		
Broccoli	1 serving 2 servings 3 servings 4 servings	Place the broccoli florets in the microwave safe bowl. Add 1-4 tbsps. of water. (1tbsp. per serving) Cover with vented(1 inch vent) plastic wrap while cooking.
Cauliflower	1 serving 2 servings 3 servings 4 servings	Place the cauliflower florets in the microwave safe bowl. Add 1-4 tbsps. of water. (1tbsp. per serving) Cover with vented(1 inch vent) plastic wrap while cooking.
Carrots	1 serving 2 servings 3 servings 4 servings	Place the carrots in the microwave safe bowl. Add 1-4 tbsps. of water. (1tbsp. Per serving) Cover with vented(1 inch vent) plastic wrap while cooking.
Green Beans	1 serving 2 servings 3 servings 4 servings	Place the green beans in the microwave safe bowl. Add 1-4 tbsps. of water. (1tbsp. per serving) Cover with vented(1 inch vent) plastic wrap while cooking.

## Microwave oven (Upper Oven)

Food	Amount	Instructions
Spinach	1 serving 2 servings 3 servings 4 servings	Place the spinach in the microwave safe bowl. Add 1-4 tbsps. of water. (1tbsp. per serving) Cover with vented(1 inch vent) plastic wrap while cooking.
Zucchini	1 serving 2 servings 3 servings 4 servings	Place the zucchini in the microwave safe bowl. Add 1-4 tbsps. of water. (1tbsp. per serving) Cover with vented(1 inch vent) plastic wrap while cooking.
Brussel Sprouts	1 serving 2 servings 3 servings 4 servings	Place the brussel sprouts in the microwave safe bowl. Add 1-4 tbsps. of water. (1tbsp. Per serving) Cover with vented(1 inch vent) plastic wrap while cooking.
<b>Frozen Vegetables</b>		
Frozen Broccoli	1 serving 2 servings 3 servings 4 servings	Place the broccoli florets in the microwave safe bowl. Add 1-4 tbsps. of water. (1tbsp. per serving) Cover with vented(1 inch vent) plastic wrap while cooking.
Frozen Carrots	1 serving 2 servings 3 servings 4 servings	Place the carrots in the microwave safe bowl. Add 1-4 tbsps. of water. (1tbsp. Per serving) Cover with vented(1 inch vent) plastic wrap while cooking.
Frozen Corn	1 serving 2 servings 3 servings 4 servings	Place the corn in the microwave safe bowl. Add 1-4 tbsps. of water. (1tbsp. Per serving) Cover with vented(1 inch vent) plastic wrap while cooking.

Food	Amount	Instructions
Frozen Green Beans	1 serving 2 servings 3 servings 4 servings	Place the green beans in the microwave safe bowl. Add 1-4 tbsps. of water. (1tbsp. Per serving) Cover with vented(1 inch vent) plastic wrap while cooking.
Frozen Peas	1 serving 2 servings 3 servings 4 servings	Place the peas in the microwave safe bowl. Add 1-4 tbsps. of water. (1tbsp. Per serving) Cover with vented(1 inch vent) plastic wrap while cooking.
Frozen Mixed Vegetables	1 serving 2 servings 3 servings 4 servings	Place the mixed vegetables in the microwave safe bowl. Add 1-4 tbsps. of water. (1tbsp. Per serving) Cover with vented(1 inch vent) plastic wrap while cooking.
<b>Grain</b>		
Oatmeal	1 pack 2 packs	Place the oatmeal in the microwave safe bowl.
Quinoa	1 cup 2 cups	Place the quinoa in the microwave safe bowl.

## Sensor Cook

The oven offers 11 different sensor cook options for your convenience, which include pre-programmed cooking times. You do not need to set either the cooking time or the power level. Once you have selected a program and touched **Start**, the oven automatically sets the cooking time and starts to cook. The gas sensing animation effect shows the status of the sensing process.

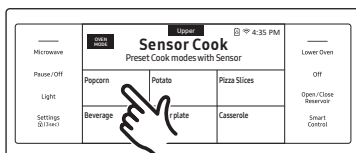

1. Put the food in the center of the turntable and close the door.
2. Select the Microwave Oven mode to **Sensor Cook**. The display will show 11 sensor cook options. (You can scroll down through the list.)
3. Tap the **Sensor Cook** option you want.
4. Tap **Start** to start cooking.
5. If you want to pause cooking, tap **Pause**. In **Pause**, you can cancel or continue cooking by tapping **Off** or **Continue**.

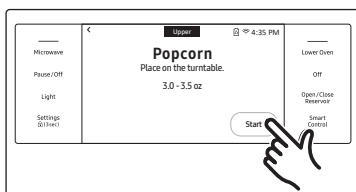

## ⚠ CAUTION

- Use only microwave-safe cookware.
- Use oven gloves when taking out food.

Food	Amount	Instructions
Popcorn	3.0-3.5 oz 1 package	Use only one microwave popcorn bag at a time. Be careful when removing the heated bag from the oven and when opening it.
Potato	1 to 5 ea	Pierce each potato several times with a fork. Place on the turntable in a spoke-like fashion. After cooking, let the potatoes stand for 3-5 minutes. Let the oven cool for at least 5 minutes before using it again.
Pizza Slices	1 to 4 slices	Place 1-4 pizza slices on a microwave safe plate with the wide ends of the slices towards the outside edge of the plate. Do not let the slices overlap. Do not cover. Let the oven cool for at least 5 minutes before using it again.
Beverage	6 to 8 oz	Use a measuring cup or mug and do not cover. Place the beverage in the oven. After heating, stir well. Let the oven cool for at least 5 minutes before using it again.

## Microwave oven (Upper Oven)

Food	Amount	Instructions
Dinner Plate	1 serving	Use only precooked, refrigerated foods. Cover the plate with vented (1 inch vent) plastic wrap or waxed paper tucked under the plate. If the food is not as hot as you would like after using the "Sensor" function, continue heating using additional time and power. <b>Contents:</b> <ul style="list-style-type: none"> <li>• 3-4 oz. meat, poultry, or fish (up to 6 oz. with bone)</li> <li>• ½ cup starch (potatoes, pasta, rice, etc.)</li> <li>• ½ cup vegetables (about 3-4 oz.)</li> </ul>
Casserole	1 to 4 servings	Cover the plate with vented (1 inch vent) plastic wrap. If the food is not as hot as you would like after using the "Sensor" function, continue heating using additional time and power. Stir the food once before serving. <b>Contents:</b> Casseroles: refrigerated
Pasta	1 to 4 servings	Cover the plate with vented (1 inch vent) plastic wrap. If the food is not as hot as you would like after using the "Sensor" function, continue heating using additional time and power. Stir the food once before serving. <b>Contents:</b> Pasta: canned spaghetti

Food	Amount	Instructions
Soup	1 to 4 servings	Cover the bowl with vented (1 inch vent) plastic wrap. If the soup is not as hot as you would like after using the "Sensor" function, continue heating using additional time and power. Stir the soup once before serving. <b>Contents:</b> Soup: refrigerated
Rice	1 to 2 cups	Add 1 cup of cold water for 1 cup of rice. Use a large glass pyrex bowl. Cover with vented (1 inch vent) plastic wrap. Rice doubles in volume during cooking. After the cooking time is over, stir before standing time, and then salt or add herbs and butter.
Fresh Vegetables	1 to 4 servings	Place the fresh vegetables (broccoli florets, cauliflower florets, zucchini, Eggplants etc.) in a microwave safe ceramic, glass, or plastic dish and add 2-4 tbs. water. Cover with vented (1 inch vent) plastic wrap while cooking and stir before letting stand. Let the oven cool for at least 5 minutes before using it again.
Frozen Vegetables	1 to 4 servings	Place the frozen vegetables in a microwave safe ceramic, glass, or plastic dish and add 2-4 tbs. water. Cover with vented (1 inch vent) plastic wrap to cook. Stir before letting stand for 3-5 minutes. Let the oven cool for at least 5 minutes before using it again.

---

### Auto sensor cooking instructions

The Auto Sensor cooks your food automatically by detecting the amount of gases generated from the food while it is cooking.

- When food is cooked, many kinds of gases are generated. The Auto Sensor determines the proper time and power level by detecting these gases, eliminating the need to set the cooking time and power level.
- When you cover a container with its lid or plastic wrap during Sensor Cooking, the Auto Sensor will detect the gases generated after the container has been saturated with steam.

#### NOTE

If using cling film or plastic wrap, leave a small opening (vent) near the edge of the dish for ventilation or pierce the plastic with a knife or fork in several places.

- Shortly before cooking ends, the remaining cooking time will begin its count down. This will be a good time for you to rotate or stir the food for even cooking if it is necessary.
- Before Auto Sensor cooking, food may be seasoned with herbs, spices, or browning sauces. A word of caution though: Salt or sugar may cause burn spots on food so these ingredients should be added after cooking.

---

### Utensils & cover

- To obtain good cooking results with the Auto Sensor function, follow the directions for selecting appropriate containers and covers in the charts in this manual.
- Always use microwave-safe containers and cover them with their lids or with plastic wrap. When using plastic wrap, turn back one corner to allow steam to escape at the proper rate.
- Always cover your microwave safe dish or container with its matching lid. If the dish or container does not have its own lid, use plastic wrap.
- Fill containers at least half full.
- Foods that require stirring or rotating should be stirred or turned toward the end of the Sensor Cook cycle, after the time has started to count down on the display.

#### CAUTION

- After installing the oven and plugging it into an electrical outlet, do not unplug the power cord for 24 hours. The gas sensor needs time to stabilize in order to cook satisfactorily.
- It is not advisable to use the Auto Sensor cooking feature continuously. i.e. one cooking operation immediately after another.
- Install the oven in a well ventilated location for proper cooling and airflow and to ensure the sensor will operate accurately.
- To avoid poor results, do not use the Auto Sensor cooking function when the room ambient temperature is above 90 °F or below 45 °F.
- Do not use volatile detergent to clean your oven. Gas resulting from this detergent may affect the sensor.
- Avoid placing the oven near high moisture or gas emitting appliances, since this will interfere with the proper performance of the Auto Sensor.
- Always keep the inside of the oven clean. Wipe all spills with a damp cloth. This oven is designed for household use only.

# Microwave oven (Upper Oven)

## Auto Cook

The oven offers 29 different auto cook options for your convenience. You do not need to set either the cooking time or the power level. You can adjust the size of the serving.

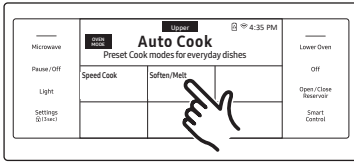

1. Put the food in the center of the turntable and close the door.
2. Select the Microwave Oven mode to **Auto Cook**. The display will show the Speed Cook and Soften/Melt menus. Choose the menu you want, and then view the auto cook programs in the menu by scrolling the list. The two menus together provide 29 auto cook options.



3. Tap the **Auto Cook** option you want.



4. Tap the weight area to select the food weight screen.

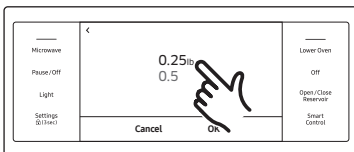

5. Flick the screen to select the food weight.
6. Tap **OK**.



7. Tap **Start** to start cooking.
8. If you want to pause cooking, tap **Pause**. In **Pause**, you can cancel or continue cooking by tapping **Off** or **Continue**.

### ⚠ CAUTION

- Use only microwave-safe cookware.
- Use oven gloves when taking out food.

Food	Amount	Instructions
<b>Speed Cook</b>		
Bacon	2 ea	Layer 2 paper towels on a microwave safe plate and arrange the bacon on the towels. Do not overlap bacon. Cover with an additional paper towel.
	4 ea	
	6 ea	
Hot Dog	2 ea	Pierce the hot dogs 3 times with a fork. Place the hot dogs on the hot plate. Place the hot dog on the hot plate, then place the plate on the low rack. When the oven beeps, add the buns and restart the oven.
	4 ea	
Nachos	1 serving	Arrange the tortilla chips uniformly on a microwave safe plate, then sprinkle evenly with cheese.
Baked Potatoes	2 ea	Pierce the potatoes 3 times with a fork. Place the potatoes on the low rack.
	4 ea	
Brownie Mix	1 pack	Pour the batter into an 8 x 8 inch cake tin, then place the tin on the low rack.
Frozen Cookie Dough	8 ea	Place 8 cookies on the hot plate, then place the plate on the low rack.

Food	Amount	Instructions
Box Cake Mix	1 pack	Pour the batter into an 8 x 8 inch cake tin, then place the tin on the low rack.
Frozen Garlic Bread	6 ea	Put frozen garlic bread on the hot plate, then place the plate on the low rack.
Homemade Lasagna	40 oz	Place a layer of lasagna sheets, then tomato and meat sauce, and then mixed cheese in an oven dish. Repeat with the remaining ingredients. Sprinkle the remaining mixed cheese evenly over the top layer of the lasagne. Place the oven dish on the low rack.
Hamburger	2 ea 4 ea	Place the 2 hamburgers on the hot plate. Place the plate on the high rack. When the oven beeps, turn the hamburgers over, and then press <b>Start</b> to continue.
Homemade Gratin	20 oz 40 oz	Layer the potato slices in the dish so that they are slightly overlapping, and then pour the milk, egg, and cream mixture over the top. Sprinkle the shredded mozzarella cheese over the top, and place the oven dish on the low rack.
Homemade Mac and Cheese	12 oz	Follow the package directions for the recommended amount of water needed. Put oven dish on the low rack and cook.
Frozen Pretzels	2 ea 4 ea	Place the frozen pretzels on the hot plate, then place the plate on the low rack.
Frozen Churros	2 ea 4 ea	Place the frozen churros on the hot plate, then place the plate on the high rack.
Quesadilla	1 ea 2 ea	Place the quesadilla on the hot plate, then place the plate on the low rack.

Food	Amount	Instructions
Chicken Breast	0.75 lb. 1.5 lbs.	Put the chicken breasts on the high rack, and hot plate on the turntable to catch drips.
Turkey Breast	0.75 lb. 1.5 lbs.	Put the turkey breasts on the high rack, and hot plate on the turntable to catch drips.
White Fish Fillet	1 ea 2 ea	Put the fish fillet on the hot plate, then place the plate on the low rack.
Meat Loaf	2.5 lbs.	In a large bowl, combine the beef, egg, onion, milk, and bread crumbs. Season with salt and pepper to taste, and then place in a lightly greased 5 x 9 inch loaf pan. Place the pan on the low rack.
Roast Beef	2.0 lbs. 3.0 lbs.	Put the sirloin on the low rack, and hot plate on the turntable to catch drips. When the oven beeps, turn over beef, and then press <b>Start</b> to continue.
Whole Chicken	4.0 lbs. 5.0 lbs.	Put breast side down in the middle of low rack, and hot plate on the turntable to catch drips. When the oven beeps, turn the chicken over, and then press <b>Start</b> to continue.

# Microwave oven (Upper Oven)

Food	Amount	Instructions
<b>Soften/Melt</b>		
Melt Butter	0.25 lb. 0.5 lb.	Place the butter in a dish and cover with wax paper.
Soften Butter	0.25 lb. 0.5 lb.	Place the butter in a dish and cover with wax paper.
Melt Chocolate	1 cup	Place the chocolate chips or squares in a microwave safe bowl.
Soften Ice Cream	1 pint 1.5 quarts	Remove the lid of the ice cream. Place the ice cream in the center of turntable.
Soften Cream Cheese	4 oz 8 oz	Unwrap the cream cheese and place in a microwave safe bowl. Cut in vertically.
Melt Cheese	4 oz 8 oz	Place the cheese in a microwave safe bowl and cover with wax paper.
Melt Marshmallows	5 oz 10 oz	Place the marshmallows in a large microwave safe dish.
Melt Caramel	4 oz 8 oz	Place the caramel in a large microwave safe dish.

## Defrost

The oven provides 4 different defrosting options for your convenience. The time and power levels are automatically adjusted according to your selection.

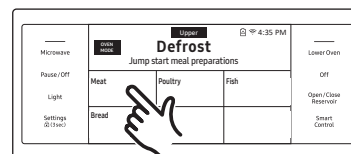

1. Put food in suitable cookware, then put the cookware on the turntable and close the door.
2. Select the Microwave Oven mode to **Defrost**. The display will show 4 defrost options.
3. Tap the **Defrost** option you want.



4. Tap the weight area to select the food weight.

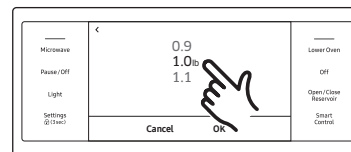

5. Flick the screen or tap the number to select the food weight. If you tap the number, the numeric pad appears.
6. Tap **OK**.

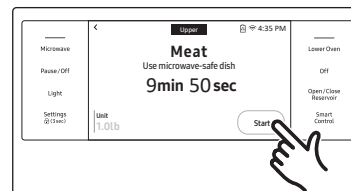

7. Tap **Start** to start defrosting.
8. If you want to pause defrosting, tap **Pause**. In **Pause**, you can cancel or continue defrosting by tapping **Off** or **Continue**.



## Oven (Lower Oven)

### ⚠ CAUTION

- Use only microwave-safe cookware.
- Use oven gloves when taking out food.

Food	Amount	Instructions
Meat	0.1-3.5 lbs.	Shield the edges with aluminium foil. Turn the meat over when the oven beeps. This program is suitable for lamb, pork, steaks, chops, and ground meat. For ground meat, place the meat directly on the turntable tray on wax paper. Do not use an extra tray. Let stand, covered with foil, for 5-10 minutes.
Poultry	0.1-3.5 lbs.	Shield the leg and wing tips with aluminium foil. Turn the poultry over when the oven beeps. This program is suitable for whole chicken as well as for chicken portions.
Fish	0.1-3.5 lbs.	Shield the tail of a whole fish with aluminium foil. Turn the fish over when the oven beeps. This program is suitable for whole fish as well as for fish fillets.
Bread	0.1-2.0 lbs.	Place bread on a ceramic plate and if possible, turn over as soon as the oven beeps. This program is suitable for all kinds of bread, sliced or whole, as well as for bread rolls and baguettes. Arrange bread rolls in a circle.

### Push to open door

**Push to open door** can be opened and closed by simply pressing it.

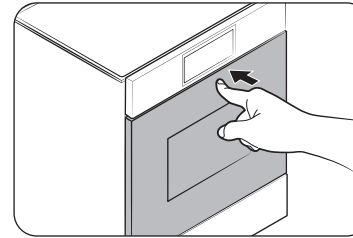

1. Press the upper side of the door.

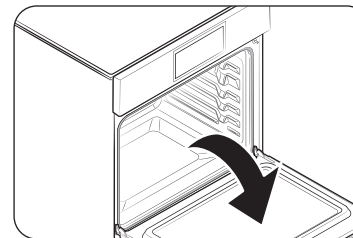

2. The door slowly open.

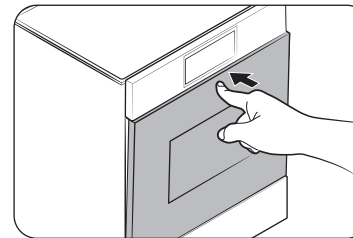

3. To close the door, press the upper side of the door again.

### ⚠ CAUTION

You can get hurt when the door opens and closes. Make sure you keep your distance from it.

# Oven (Lower Oven)

## Timed cooking

In timed cooking mode, the oven turns on immediately and cooks for the length of time you select.

At the end of the cooking time, the oven turns off automatically.

- You can use the timed cooking feature only with another cooking operation. (Bake, Convection Bake, Convection Roast, Convection Vegetable, Steam Bake, Steam Roast, Steam Cook, Air-Fry, Air Sous Vide, Steam Proof, Proof, Dehydrate).

### How to set the oven for timed cooking



- Tap the screen and then swipe to the cooking operation you want.
- Tap **Cook Time**. The display will change to the cooking time screen.



- Tap numbers on the numeric pad to set the cooking time. (You can set the cooking time for any amount of time from 1 minute to 9 hours and 59 minutes).



- The cooking time is displayed in the Cook Time area on the screen.
- You can cancel a cook time at any time by setting the Cook Time to 0 minutes.

### ⚠ CAUTION

Be careful when using the timed cooking or delay start features. You can use these features to cook cured or frozen meats and most fruits and vegetables.

For food that can easily spoil, such as milk, eggs, and unfrozen or fresh fish, meat, or poultry, chill them in the refrigerator first.

Even when chilled, they should not stand in the oven for more than 1 hour before cooking begins, and should be removed promptly when cooking is completed.

Eating spoiled food can result in sickness from food poisoning.

## Delay start

In the delay timed cooking mode, the oven's timer turns the oven on at a time you select in advance. You can have the oven turn off automatically after a set time has elapsed by setting the Timed Cooking function as well.

- You can use the delay start feature only with another cooking operation (Bake, Convection Bake, Convection Roast, Convection Vegetable, Steam Bake, Steam Roast, Steam Cook, Air-Fry, Air Sous Vide, Steam Proof, Proof, Dehydrate, Self Clean).
- You can set the oven for a delay start before setting other cooking operations.
- The clock must be set to the current time.

### How to set the oven for delay timed cooking

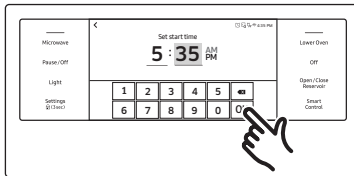

- Position the oven rack(s) and place the food in the oven.
- Tap the screen and then swipe to the cooking operation you want.
- Set the cooking time if you want the oven to turn off automatically after a set time. (See the **Timed cooking** section on page 42.)
- Tap **Delay Start**. The current time is displayed as the first entry.
- Tap numbers on the numeric pad to set the time you want the oven to start.

- The Delay Start screen closes. The start time, and, if you set it, the cooking time, is displayed on the screen.

## Using the Temp probe

For many foods, especially roasts and poultry (beef, chicken, turkey, pork, lamb, etc), measuring the internal temperature is the best way to determine if the food is properly cooked. The Temp probe lets you cook meat to the exact internal temperature you want, taking the guess work out of determining whether a piece of meat is done or not. This function can be used with Bake, Convection Bake, Convection Roast, or Convection Vegetable. After the internal temperature of the food reaches 100 °F, the increasing internal temperature will be shown in the display.

### How to use the Temp probe

- Push the tip of the Temp probe into the meat as fully as possible, so that the tip is in the center of the meat.

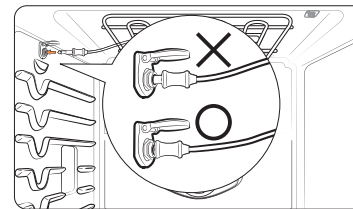
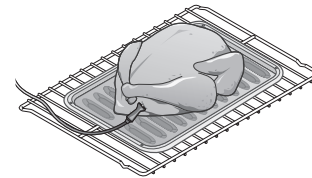
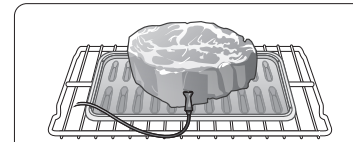

- Insert the probe completely into the meat as shown in the illustrations. It should not touch bone, fat, or gristle.
- If you do not fully insert the probe into the meat, the Temp Probe function will not work properly as the probe will sense the oven temperature and not the temperature of the meat.
- For bone-in meats, insert the probe into the center of the lowest and thickest portion of the piece.
- For whole poultry (turkey, large chickens, etc.), insert the probe into the thickest part of the inner thigh, parallel to the leg.
- If you activate the Keep Warm function to keep the meat warm after you have cooked it using the Temp Probe function, the meat's internal temperature will exceed the temperature you want.

## Oven (Lower Oven)

2. Insert the temp probe plug into the socket on the top side wall of the oven as far as it will go.
3. Tap the screen oven to select the desired cooking mode (Bake, Convection Bake, Convection Roast, or Convection Vegetable. Set the cooking temperature. (See page 24.)
4. Tap **Temp Probe** to set the desired internal temperature.
5. Set the desired internal temperature using the numeric pad.

Available temperatures	100 °F to 200 °F
------------------------	------------------

6. If you want to use the Cook time or Delay start, select the desired function.
7. Tap **Start**.
8. When the desired internal temperature is reached, the function automatically stops and an alarm sounds.

### CAUTION

- To protect the Temp probe's tip, be careful not to insert the probe so that the tip protrudes through the surface of the meat. Make sure that the tip is in or near the center of the meat.
- Do not store the probe in the oven.
- Do not leave the probe inside the oven during a self-cleaning or broiling cycle. You can permanently damage the probe and it will no longer work.
- To avoid breaking the probe's tip, defrost your food completely.
- Do not use tongs when inserting or removing the probe. Tongs can damage the probe.
- Use the Temp probe for Temp probe function cooking only. Do not use the Temp probe for any other purpose.

### NOTE

- If you remove the temp probe while the temp probe function is operating or insert the temp probe while baking or cooking normally, cooking will stop after 1 minute.
- If you use the probe to cook frozen food, there are times when it cannot be detected. (The probe icon won't appear in the display.)

### Temp probe table

Type of Food		Internal temperature
Beef / Lamb	Rare	140 °F
	Medium	160 °F
	Well done	170 °F
Pork		170 °F
Poultry		180 - 185 °F

### NOTE

If you cover the meat with aluminum foil and allow it to stand for 10 minutes after cooking, the Internal temperature will rise 5 - 10 degrees.

### Removing the Temp probe

Remove the temp probe plug from the socket.

### CAUTION

After cooking, the Temp probe is hot enough to cause burns. Let it cool sufficiently before attempting to remove it.

## Twin cooking mode temperature setting ranges

Using the divider, you can divide the oven into two compartments, upper and lower. This is also called twin mode. When you use the upper and lower compartments in the oven at the same time, each oven has a minimum and maximum amount of power available and consequently minimum and maximum temperature settings.

Oven temperatures in the lower compartment also limit broil settings in the upper compartment. The temperature and broil setting limitations are shown in the table below and on the next page.

UPPER COMPARTMENT		LOWER COMPARTMENT (Available function settings and temperatures)	
Mode	Set Temp.	Bake, Convection Bake	
		Min	Max
Broil	Hi	400 °F	480 °F
	Low	325 °F	480 °F
Convection Bake / Convection Roast	480 °F	400 °F	480 °F
	450 °F	350 °F	480 °F
	300 °F	250 °F	375 °F
	250 °F	225 °F	300 °F
	175 °F	175 °F	200 °F

### NOTE

To insert the divider, see page 65.

LOWER COMPARTMENT		UPPER COMPARTMENT (Available function settings and temperatures)			
Mode	Set Temp.	Broil		Convection Bake, Convection Roast	
		Low	Hi	Min	Max
Bake / Convection Bake	480 °F	O	O	400 °F	480 °F
	450 °F	O	O	350 °F	480 °F
	350 °F	O	X	275 °F	450 °F
	325 °F	O	X	275 °F	400 °F
	250 °F	X	X	225 °F	300 °F
	175 °F	X	X	175 °F	200 °F

O = Available

X = Not Available

### NOTE

The twin cooking mode lets you use different settings for the upper and lower compartments, such as different switch off times, cooking times, and temperatures settings.

To apply or modify settings in either compartment, tap the respective touch pad.

# Oven (Lower Oven)

Oven		Oven functions	
<div style="border: 1px solid black; padding: 5px; margin-bottom: 5px;">Upper Microwave Oven</div> <div style="border: 1px solid black; padding: 5px;">Single Lower</div> <p><b>Without a divider</b></p>	<p><b>Single oven</b></p>	Upper	Microwave, Power Convection, Broil, Speed Power Convection, Speed Broil, Air Fry Auto Cook, Healthy Cook, Sensor Cook, Auto Cook, Defrost
		Lower	Bake, Broil, Convection Bake, Convection Roast, Convection Vegetable, Steam Bake, Steam Roast, Air-Fry, Air Sous Vide, Steam Cook, Keep Warm, Steam Proof, Proof, Dehydrate, Smart Control, Clean
<div style="border: 1px solid black; padding: 5px; margin-bottom: 5px;">Upper Microwave Oven</div> <div style="border: 1px solid black; padding: 5px; margin-bottom: 5px;">Flex Upper</div> <div style="border: 1px solid black; padding: 5px;">Flex Lower</div> <p><b>With a divider</b></p>	<p><b>* Twin oven</b></p>	Flex Upper	Broil, Convection Bake, Convection Roast, Smart Control
		Flex Lower	Bake, Convection Bake, Smart Control

\* To use the twin flex oven functionality, you must insert the divider into the upper oven and divide it into an upper and lower compartment. See page 65.

## Cooking mode

Tap the screen to select the cooking mode.

Set the temperature using the numeric pad or the wheel picker. See **Setting the Temperature** on page 24 and **Basic Baking and Broiling Instructions** starting on page 52.

Mode	Temperature range		Single oven	*Twin oven		Temp probe	\
	Single oven	*Twin oven		Upper	Lower		
Bake	175 °F (80 °C) - 550 °F (285 °C)	175 °F (80 °C) - 480 °F (250 °C)	0	-	0	0	-
Broil	LO / HI	LO / HI	0	0	-	-	-
Convection Bake	175 °F (80 °C) - 550 °F (285 °C)	175 °F (80 °C) - 480 °F (250 °C)	0	0	0	0	0
Convection Roast	175 °F (80 °C) - 550 °F (285 °C)	175 °F (80 °C) - 480 °F (250 °C)	0	0	-	0	0
Convection Vegetable	350 °F (175 °C) - 450 °F (230 °C)	-	0	-	-	0	-
Steam Bake	230 °F (110 °C) - 550 °F (285 °C)	-	0	-	-	-	-
Steam Roast	230 °F (110 °C) - 550 °F (285 °C)	-	0	-	-	-	-
Steam Cook	0	-	0	-	-	-	-
Air fry	350 °F (175 °C) - 500 °F (260 °C)	-	0	-	-	-	-
Air Sous Vide	100 °F (40 °C) - 205 °F (95 °C)	-	0	-	-	-	-
Dehydrate	100 °F (40 °C) - 225 °F (105 °C)	-	0	-	-	-	-
Proof	95 °F (35 °C) or 105 °F(40 °C)	-	0	-	-	-	-
Steam Proof	95 °F (35 °C) or 105 °F(40 °C)	-	0	-	-	-	-
Keep Warm	175 °F (80 °C)	-	0	-	-	-	-

O = Available      - = Not Available

\* To use the twin oven functionality, you must insert the divider into the upper oven and divide it into an upper and lower compartment. See page 65.

Mode	Instruction
Bake	<ul style="list-style-type: none"> <li>Bake is used to cook cakes, cookies, and casseroles. Always preheat the oven first.</li> <li>Baking temperatures and times will vary depending on the ingredients and the size and shape of the baking pan used.</li> <li>Dark or nonstick coatings may cook faster with more browning.</li> </ul> <p> <b>NOTE</b> For performance reasons, the convection fan may turn on or off during baking.</p>
Broil	<ul style="list-style-type: none"> <li>Broiling is a method of cooking tender cuts of meat by direct heat under the broil element of the oven.</li> <li>The high heat cooks quickly and gives a rich, brown outer appearance. Broil mode is best for meats, fish, and poultry up to 1 inch thick.</li> <li>Always preheat the oven for 5 minutes before broiling.</li> <li>See the <b>Broiling recommendation guide</b> section starting on page 49.</li> </ul>
Convection Bake	<ul style="list-style-type: none"> <li>Convection Bake uses a fan to circulate the oven's heat evenly and continuously within the oven.</li> <li>This improved heat distribution allows for even cooking and excellent results while using multiple racks at the same time.</li> <li>Breads and pastries brown more evenly.</li> </ul>
Convection Roast	<ul style="list-style-type: none"> <li>Convection Roast is good for cooking large tender cuts of meat, uncovered. The convection fan circulates the heated air evenly over and around the food.</li> <li>Meat and poultry are browned on all sides as if they were cooked on a rotisserie.</li> <li>The heated air seals in juices quickly for moist and tender results while, at the same time, creating a rich golden brown exterior.</li> </ul>
Steam Bake	<ul style="list-style-type: none"> <li>Steam Bake provides excellent baking conditions for breads, pastries, and desserts by increasing moisture content and improving texture and flavor.</li> <li>See the <b>Steam cook</b> section starting on page 55.</li> </ul>

Mode	Instruction
Steam Roast	<ul style="list-style-type: none"> <li>Steam Roast provides excellent cooking conditions for roasted meats or poultry by maintaining a crispy surface while sealing in the juices for a moist and tender result.</li> <li>See the <b>Steam cook</b> section starting on page 55.</li> </ul>
Steam Cook	<ul style="list-style-type: none"> <li>Steam Cook allows you to use an indirect cooking method that uses hot steam generated from water to cook food.</li> <li>The hot steam from the steam generator is injected through the steam nozzle into the oven to cook food. This mode is a healthy way to cook vegetables, meats and fish so they keep their nutrients.</li> <li>For the best results, use this mode in single oven mode and place the Steam container in position 1.</li> <li>Preheating is not necessary for this mode.</li> </ul>
Air Fry	<ul style="list-style-type: none"> <li>Air Fry uses hot air for crispier and healthier frozen or fresh foods without or less oil than normal convection mode.</li> <li>For best results, use this mode in single oven mode and place the Air Fry tray in position 3.</li> <li>Preheating is not necessary for this mode.</li> <li>The temperature can be set between 350°F - 500°F.</li> <li>See the <b>Air Fry</b> section starting on page 50.</li> </ul>

## Oven (Lower Oven)

Mode	Instruction
Air Sous Vide	<ul style="list-style-type: none"> <li>• Air sous vide mode uses low-temperature hot air to implement Sous Vide mode without steam or the water tank.</li> <li>• In this mode, the oven keeps constant low temperatures, cooking food that can keep its original fragrance and nutrients while offering enriched flavor and soft texture.</li> <li>• It is not necessary to preheat the oven when using Air Sous Vide mode.</li> <li>• Place the sealed vacuum bags of food on the rack 3 of the oven.</li> <li>• The temperature can be set between 100°F - 205°F.</li> <li>• Use it to cook meat, fish, seafood, poultry or vegetables.</li> <li>• Use fresh and quality ingredients only. Trim them in a clean condition and store under refrigeration.</li> <li>• Use heat-resistant vacuum bags for moving and storing ingredients.</li> <li>• Use Air Sous Vide recommendation guide. To find the recommended cooking time and temperature for the food.</li> <li>• See the Air Sous Vide recommendation guide section starting on page <b>56</b>.</li> </ul>

Mode	Instruction
Convection Vegetable	<ul style="list-style-type: none"> <li>• Convection Vegetable provides excellent cooking conditions for vegetables such as potatoes, tomatoes, onions, carrots, bell peppers, broccoli and It creates optimal texture and taste for vegetable by increasing moisture content when compared to general convection.</li> <li>• The uniform air circulation provided by Pure Convection allows you to use more oven capacity at once.</li> <li>• For best results, use this mode in single oven mode and place the cooking tray in position 3.</li> <li>• Preheating is not necessary for this mode.</li> <li>• See the Convection Vegetable recommendation guide section starting on page <b>58</b>.</li> </ul> <p> <b>NOTE</b> For performance reasons, the convection fan may turn on or off during baking.</p>
Dehydrate	<ul style="list-style-type: none"> <li>• Dehydrate dries food or removes moisture from food via heat circulation. Place the food on rack position 3 or 4.</li> <li>• After drying the food, keep it in a cool and dry place.</li> <li>• For fruit, adding lemon or pineapple juice or sprinkling sugar on the fruit helps the fruit retain sweetness.</li> <li>• See the table below for Dehydrate settings.</li> </ul>
Proof	<ul style="list-style-type: none"> <li>• Proof provides an optimal temperature for the bread proofing process, and therefore does not require a temperature adjustment.</li> <li>• Place the dough on rack position 2. Proof needs to cover with cloth or with plastic wrap.</li> <li>• For the best results, always start the Proof option with a cool oven.</li> </ul>



Mode	Instruction
Steam Proof	<ul style="list-style-type: none"> <li>For bread dough (yeast dough and sour dough), added steam shortens fermentation time and keeps the surface of the dough from drying out.</li> <li>Place the dough on rack position 2 or 3. There is no need to cover it with cloth or with plastic wrap.</li> <li>For the best result, always start the Steam Proof option with a cool oven.</li> <li>Do not use Steam Bread Proof for warming food. The proofing temperature is not hot enough to keep food warm.</li> </ul>
Keep Warm	<ul style="list-style-type: none"> <li>The keep warm mode will keep cooked food warm for serving up to 3 hours after cooking has finished.</li> <li>You can use the keep warm mode without any other cooking operations or you can set it to activate after a timed or delay timed cooking operation.</li> <li>You should not use this mode to reheat cold food.</li> </ul>

## Broiling recommendation guide

The size, weight, thickness, starting temperature, and your doneness preference will affect broiling times. This guide is based on meats at refrigerator temperature. Always use a broiler pan and its grid when broiling. Always preheat the oven for 5 minutes before broiling.

Food	Doneness	Size	Thickness	Level	Rack position	Cooking time(min)	
						1st side	2nd side
Hamburgers	Medium	9 patties	3/4"	Hi	6	3:00	2:00
	Medium	9 patties	1"	Hi	6	3:20	2:20
Beef steaks	Rare	-	1"	Hi	5	5:00	4:00
	Medium	-	1 - 1 1/2"	Hi	5	6:00 - 6:30	4:30 - 4:00
	Well done	-	1 - 1 1/2"	Lo	4	7:00 - 8:00	4:00 - 5:00
Chicken pieces	Well done	4.5 lbs.	1/2 - 3/4"	Lo	3	16:00 - 18:00	13:00 - 15:00
	Well done	2 lbs.	1/2 - 3/4"	Lo	3 or 4	15:00 - 16:00	10:00 - 12:00
Pork chops	Well done	1 lbs.	1"	Lo	3	8:00 - 10:00	6:00 - 8:00
Fish fillets	Well done	-	1/4 - 1/2"	Lo	3 or 4	7:00 - 8:00	4:00 - 5:00

# Oven (Lower Oven)

## Air Fry

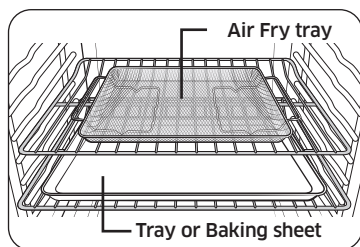

**Air Fry Tray recommended placement**

### NOTE

- Place a baking sheet or tray on the rack below the Air Fry Tray for getting any drippings. This will help to reduce splatter and smoke for high fat foods, such as chicken wings.
- Air Fry is designed for baking on a single oven rack. Place food on rack position 3 for best results. (Rack position number counts from the bottom.)

- Before using a baking ware, check the maximum allowable temperature of baking sheet.
- Place under a few sheets of paper like parchment paper to absorb the fat for reducing splatter and smoke during the Air Fry.
- For cooking fresh or homemade foods, spread the oil over a larger area more evenly, crisping up the food more effectively.
- Wet or thicken coating will not crisp or set to use with the Air Fry.

### CAUTION

- Foods that are high in fat fat will smoke when using the Air Fry model, such as chicken wings, bacon, sausage and turkey legs.
- Before you start Air Fry, turn on an exhaust hood at a high level fan setting.
- Open a window in your kitchen if it is possible to make sure the kitchen is well-ventilated.
- Once the oven has cooled, wipe down the interior of the oven before and after Air Fry cooking.
- Regularly, clean the grease filters of exhaust hood for preventing smoke during cooking.
- Avoid opening the oven door, or else it is difficult to maintain the oven temperature, prevent heat loss, and save energy.

### NOTE

- Preheating is not necessary.
- Place the Air Fry Tray on position 3.
- It is recommended to use avocado oil.
- Place a baking sheet or tray on the rack below the Air Fry Tray to catch any drippings. This will help to reduce splatter and smoke.

### Air Fry recommendation guide

Item	Amount	Temperature	Time	Tips
<b>Potatoes</b>				
Frozen French Fries	30 - 35 oz	425 °F - 450 °F	25 - 30 min	-
Frozen French Fries, Seasoned	25 - 30 oz	425 °F - 450 °F	20 - 25 min	-
Frozen Tater Tots	40 - 45 oz	450 °F	20 - 25 min	-
Frozen Hash Brown	25 - 30 oz	450 °F	20 - 25 min	-
Frozen Potato Wedges	30 - 35 oz	425 °F - 450 °F	20 - 25 min	-
Homemade French Fries	25 - 30 oz	425 °F	25-30 min	Peel potatoes and cut into sticks with a thickness of ½ inch. Soak in cold water for 30 min. Brush with 3tbsp of oil. Add salt and pepper to taste.
Homemade Potato Wedges	25 - 30 oz	450 °F	25 - 30 min	Cut them into wedges. Brush with 3 tbsp of oil. Add salt and pepper to taste.

Item	Amount	Temperature	Time	Tips
<b>Frozen</b>				
Frozen Chicken Nuggets	24 - 28 oz	400 °F - 425 °F	15 - 25 min	-
Frozen Chicken Wings	30 - 35 oz	425 °F	20 - 30 min	-
Frozen Onion Rings	20 - 25 oz	425 °F	15 - 20 min	-
Frozen Fish Fingers	20 - 25 oz	425 °F	18 - 22 min	-
Frozen Chicken Strips	25 - 30 oz	425 °F - 450 °F	25 - 30 min	-
Frozen Churros	20 - 25 oz	425 °F	18 - 22 min	-
<b>Poultry</b>				
Fresh Drumsticks	35 - 45 oz	425 °F - 450 °F	30 - 35 min	Brush with 3 tbsp of oil. Add salt and pepper to taste. Air frying foods that are high in fat can create smoke.
Fresh Chicken Wings	30 - 35 oz	425 °F - 450 °F	25 - 30 min	
Chicken Breasts, Breaded	30 - 35 oz	400 °F - 425 °F	25 - 30 min	Dip chicken breasts into the flour mixture. Whisk the egg and milk. Dip flour coated breasts into the egg mixture. Place them into breaded crumbs and toss until items are coated with crumbs. Add salt and pepper to taste. Brush with 3 tbsp of oil.

Item	Amount	Temperature	Time	Tips
<b>Vegetables</b>				
Asparagus, Breaded	15 - 20 oz	425 °F	20 - 25 min	Dip sliced vegetables into the flour mixture. Whisk the egg and milk. Dip flour coated vegetables into the egg mixture. Place them into breaded crumbs and toss until items are coated with crumbs. Add salt and pepper to taste. Brush with 3 tbsp of oil.
Egg Plants, Breaded	20 - 25 oz	425 °F	20 - 25 min	
Mushroom, Breaded	18 - 22 oz	425 °F	20 - 25 min	
Onions, Breaded	18 - 22 oz	425 °F	20 - 25 min	
Cauliflowers, Breaded	18 - 22 oz	400 °F - 425 °F	20 - 25 min	
Vegetable Mix, Breaded	30 - 35 oz	400 °F - 425 °F	20 - 25 min	

# Oven (Lower Oven)

## Setting the mode

### Swipe the screen

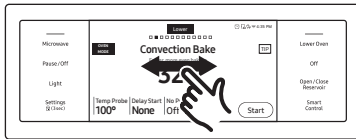

Swipe the screen to select mode you want. (You can swipe left or right).

### Summarized mode

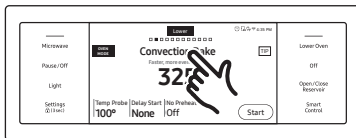

1. Tap the mode area or Oven Mode to display the summarized mode.

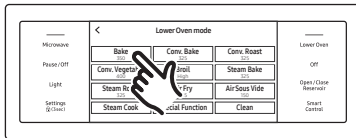

2. Tap the mode you want.

## Setting the temperature



1. Tap the temperature area to display the numeric pad.
2. Tap the numbers on the numeric pad to set the temperature.
3. Tap **OK**.

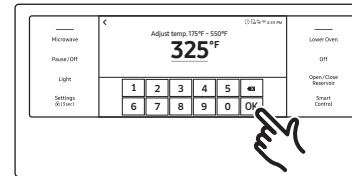

## Basic baking and broiling instructions



1. Tap the screen and then swipe to select the desired cooking mode.



2. Set the temperature you want. (See the **Setting the temperature** section on this page.)
  - Broil mode can be set only Hi or Low.
  - Keep Warm temperature is fixed and cannot be changed.

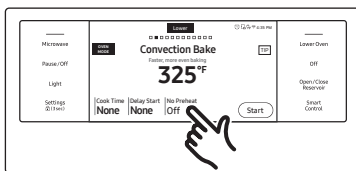

- Follow the steps below to use the No Preheat, Steam Bake, or Steam Roast feature. If you are not using these features, skip these steps and go to Step 4 on the next page.

### No Preheat

- If you select Convection Bake or Convection Roast, the display will show the No Preheat information. (The default is **Off**).
- Tap the **No Preheat**.  
The No Preheat feature is activated and the display will show **On**.

### NOTE

- For best performance, we recommend cooking on a single rack.

Type	Rack Positions
Baking	3 or 4
Roasting	1 or 2

- Place food in the oven before you start cooking when using the No Preheat feature.
- For best performance, preheat the oven when baking rising bakery products such as angel food cakes, bundt cakes, or puff pastries.

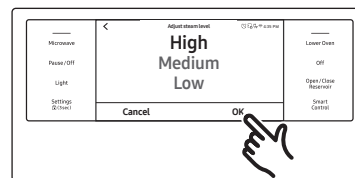

### Steam Bake, Steam Roast

- If you selected Steam Bake or Steam Roast, the display will show the steam-level information. (The default is Medium).
- Tap the Steam area to adjust the steam level. The steam-level adjustment screen appears. You can set the steam level to Low, Medium, or High.
- Tap **OK**. The steam-level adjustment screen closes and the steam-level information is displayed on the screen.

**Important** : You must fill the water reservoir before you start steam cooking. See the **Water reservoir** section on page 22.

- If you want to use the Cook Time, or Delay Start function, set each function now. See pages 42 and 43 for instructions.
- Tap **Start** to begin cooking.
- Tap **Off** when cooking is done or if you want to cancel cooking.

# Oven (Lower Oven)

## NOTE

When Steam Cook is enabled and the water reservoir runs out of water, the display will show "Please add more water".  
The oven continues to operate but the steam generator stops operation until you refill the water reservoir with water.  
See the **Draining** section starting on page 70.

## Steam Bake, Steam Roast recommendation guide

Steam mode	Steam level	Recommended Foods
Steam Bake	High	Rye breads, Desserts (Flan caramel)
	Med	Croissants, Pies, Reheats (Pizza, Casserole)
	Low	Pastries
Steam Roast	High	-
	Med	Meats, Poultry
	Low	Turkey, Large meats

## How to adjust the temperature while cooking



Tap the temperature area, enter the new temperature using the numeric keypad and then tap **OK**.



## CAUTION

- Place food in the oven after preheating if the recipe calls for it. Preheating is very important for good results when baking cakes, cookies, pastry, and breads.
- The convection oven fan shuts off when the oven door is opened.
- DO NOT leave the door open for long periods of time while using convection cooking or you may shorten the life of the convection heating element.

## NOTE

- If you leave the oven door open for more than 2 minutes when the oven is on, all heating elements will shut off automatically.
- When you have finished cooking, the cooling fan will continue to run until the oven has cooled down.
- Make sure to drain the remaining water after using steam cooking. Once the oven starts draining, wait until the draining cycle is complete.
- When a steam function is complete, you must empty the water reservoir because the remaining water can affect other cooking modes.
- If you are using an oven thermometer in the oven chamber, the temperature registered by the thermometer may differ from the actual set oven temperature.
- For performance reasons, the convection fan may turn on or off while the oven is operating.
- This oven is designed for closed-door broiling. The oven door must be closed during broiling.

## CAUTION

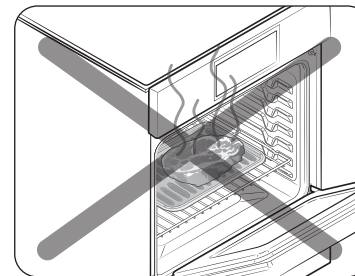

Always broil with the oven door closed. Use care when opening the door. Let hot air or steam escape before you remove food from or put food into the oven.

## Steam Cook

### Replacing the wire rack steam and steam container

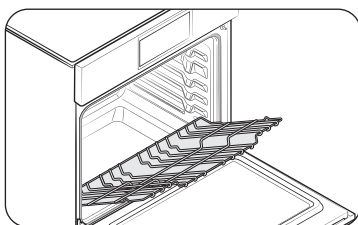

1. Place the end of the wire rack steam on the support.

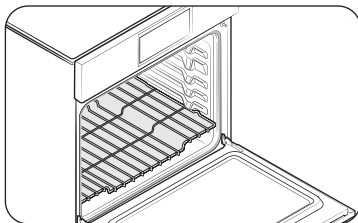

2. Tilt the front end up and push the rack in.

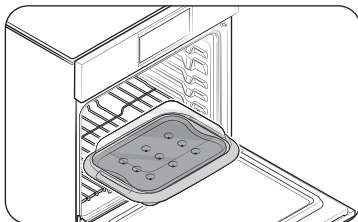

3. Place the steam container on the rack.

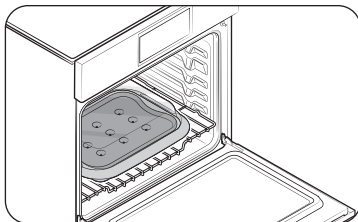

4. Push the container in until the steam nozzle enters the hole on the convection fan cover.

### Steam Cook recommendation guide

- Preheating is not required, it can be cooked immediately.
- Fill the reservoir with water up to the max line before using.
- Use the Steam container, place it in position 1.
- Use the Wire rack steam for the Steam container. (See the **Introducing your new oven** section starting on page 20.)

Items	Accessories	Rack position	Cooking time (min)
Broccoli florets	Steam container, Wire rack steam	1	10 - 15
Asparagus, green	Steam container, Wire rack steam	1	10 - 15
Asparagus, white	Steam container, Wire rack steam	1	15 - 20
Green beans	Steam container, Wire rack steam	1	10 - 15
Brussel sprouts	Steam container, Wire rack steam	1	15 - 20
Peeled potato halves	Steam container, Wire rack steam	1	25 - 35
Spinach	Steam container, Wire rack steam	1	10 - 13
White fish, fillets	Steam container, Wire rack steam	1	20 - 25
Salmon, fillets	Steam container, Wire rack steam	1	20 - 25
Prawns	Steam container, Wire rack steam	1	15 - 20
Mussels, on the half shell	Steam container, Wire rack steam	1	15 - 20
Chicken breasts	Steam container, Wire rack steam	1	25 - 35
Eggs, boiled	Steam container, Wire rack steam	1	20 - 30

\* This table is for reference only.

# Oven (Lower Oven)

## CAUTION

- The steam container becomes hot during cooking. Make sure you wear oven gloves to remove it.
- Be careful hot steam when you remove the glass lid of the steam container after finishing.
- Make sure to insert fully into the compartment so the container touches the rear wall.

## NOTE

- See the **Steam container** section starting on page **55**.
- See the **Water reservoir** section starting on page **22**.

## Air Sous Vide

- It is not necessary to preheat the oven when using Air Sous Vide mode.
- Use it to cook meat, fish, seafood, poultry or vegetables.
- Use fresh and quality ingredients only. Trim them in a clean condition and store under refrigeration.
- Use heat-resistant vacuum bags for this mode surely.
- Use heat-resistant vacuum bags for moving and storing ingredients.
- Do not reuse the heat-resistant bags.
- Place the sealed vacuum bags of food on the rack 3 of the oven.
- The temperature can be set between 100 °F - 205 °F
- Only use temperature below 140 °F (60 °C) to cook foods that can be safely eaten raw.

### Air Sous Vide recommendation guide

Food	Doneness	Temperature(°F)	Time(hrs.)
<b>Beef</b>			
Steak, 1.5" thick	Rare	130 °F	2.5 - 4
Steak, 1.5" thick	Medium	140 °F	2.5 - 4
Steak, 1.5" thick	Well done	155 °F	2.5 - 4
Roast	Medium	150 °F	6 - 12
Roast	Well done	155 °F	6 - 12
<b>Pork</b>			
Chop, boneless	Tender	150 °F	3 - 5
Chop, boneless	Firm	160 °F	3 - 5
Roast	Medium	150 °F	4 - 6
Roast	Well done	160 °F	4 - 6
Pulled pork	Well done	160 °F	15 - 48



Food	Doneness	Temperature(°F)	Time(hrs.)
<b>Poultry</b>			
Chicken, breast	Tender	145 °F	2.5 - 4
Chicken, breast	Firm	160 °F	3 - 4
Duck, breast	Tender	145 °F	3 - 4
<b>Fish</b>			
Salmon steak	Tender	130 °F	2 - 3
Salmon steak	Well done	145 °F	1.5 - 3
Cod fillet	Tender	130 °F	1.5 - 3
<b>Vegetables</b>			
Asparagus	-	180 °F	0.5 - 2
Potato, sliced	-	200 °F	2 - 4
Sweet potato, sliced	-	200 °F	2 - 4
Carrot, sliced	-	190 °F	2 - 4
Squash, cubes	-	180 °F	2 - 4
<b>Fruit</b>			
Apple, sliced	-	180 °F	1 - 2
Pineapple, sliced	-	180 °F	1 - 2
Pear, sliced	-	180 °F	1 - 2

\* This table is for reference only.

#### NOTE

- The cooking time depends on the thickness of food. Addition of salt or sugar may shorten the cooking time.
- Use Air Sous Vide recommendation guide to find the recommended cooking time and temperature for the food.
- Only use temperatures below 140 °F (60 °C) to cook foods that can be safely eaten raw.
- To keep the original taste, we recommend you use less herbs and spices than in ordinary recipes.
- Meat and fishery offer better flavors when seared and served.
- Sous vide dishes are best served immediately after cooking.
- If not served immediately after cooked, put the food in ice water and cool down completely. Then, store them under 40 °F (5 °C) to keep the fragrance and texture of food.

# Oven (Lower Oven)

## Convection Vegetable

### Convection Vegetable recommendation guide

- Preheating is not necessary.
- For best results, use this mode on a single oven rack and place the dish on the rack position 3.
- The temperature can be set between 350 °F - 450 °F. The default temperature is 400 °F.

Items	Temperature	Rack position	Cooking time(min)
Potatoes	375 - 425 °F	3	45 - 65
Tomatoes, sliced	425 - 450 °F	3	15 - 20
Onions, sliced	400 - 425 °F	3	15 - 25
Carrots, sliced	375 - 425 °F	3	30 - 45
Bell peppers, sliced	375 - 425 °F	3	15 - 25
Broccoli, florets	400 - 425 °F	3	15 - 20
Cauliflower, florets	400 - 425 °F	3	15 - 20
Asparagus	425 - 450 °F	3	15 - 20
Mushroom	425 - 450 °F	3	15 - 25
Zucchini, quartered lengthwise	375 - 400 °F	3	30 - 50
Squash, sliced	375 - 400 °F	3	30 - 50
Eggplant, sliced	400 - 425 °F	3	15 - 20
Green beans	400 - 425 °F	3	15 - 20

\* This table is for reference only.

### NOTE

- When cooking vegetables, place baking paper on a baking sheet or tray to catch any drippings.
- It is recommended to use some oil such as olive oil or avocado oil and some salt or pepper.
- It is recommended to serve with fresh herbs such as basil leaves, rosemary leaves and grated cheeses as your taste after cooking.
- Serve cooked vegetables with your favorite main dish.
- It is recommended to take cooked vegetables every day for your health.
- Vegetables not listed in the table are recommended to be cooked at the default temperature at first, and then cooked at a higher or lower temperature.
- For performance reasons, the convection fan may be turned on or off during the operation automatically.
- For more information, the Samsung website offers special menus and recipes to enjoy cooked vegetables on the guide table, you can download detailed recipes for each feature from the our website([www.samsung.com/us/support](http://www.samsung.com/us/support)).

## Using the special function feature

Special function provides 4 different specialized cooking options.

Mode	Temperature range
Keep Warm	**None
Proof	95 °F (35 °C) / 105 °F (40 °C)
Steam Proof	95 °F (35 °C) / 105 °F (40 °C)
Dehydrate	100 °F (40 °C) - 225 °F (105 °C)

\*\* None means that a factory set temperature is applied for the best performance. You cannot adjust this temperature.

### Proof

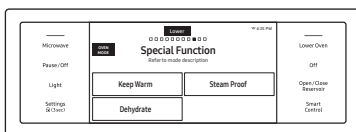

1. Swipe the screen to the **Special Function**. The display will show the specialized cooking options.

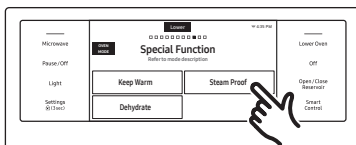

2. Tap the cooking option you want.



3. Set the temperature you want.
4. Tap **Start**.

#### NOTE

You cannot adjust the temperature on Keep Warm mode.

### CAUTION

- Do not use Proof when the oven temperature is above 125 °F. If temperature is above 125 °F, this mode won't function properly. Wait until the oven cools down.
- Do not use Proof for warming food. The proofing temperature is not hot enough to keep food warm.
- Place the dough in a heat-safe container on rack position 2 and cover it with a cloth or with plastic wrap. You may need to anchor the plastic wrap underneath the container so that the oven does not blow the plastic wrap off the dough.
- To avoid lowering the temperature and extending proofing time, do not open the oven door.

### Steam Proof



1. Swipe the screen to the **Special Function**. The display will show the specialized cooking options.

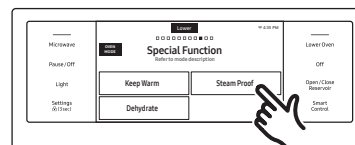

2. Tap the cooking option you want.



3. Tap Add Steam and set the temperature you want.



4. Tap **Start**.

# Oven (Lower Oven)

## CAUTION

- Do not use Steam Proof when the oven temperature is above 125 °F. If temperature is above 125 °F, this mode won't function properly. Wait until the oven cools down.
- Do not use Steam Proof for warming food. The proofing temperature is not hot enough to keep food warm.
- Place the dough in a heat-safe container on rack position 2 or 3 and cover it with a cloth or with plastic wrap. You may need to anchor the plastic wrap underneath the container so that the oven does not blow the plastic wrap off the dough.
- To avoid lowering the temperature and extending proofing time, do not open the oven door.

## NOTE

- Preheating is not necessary on special function feature.
- An error beep sounds if the temperature setting is out of the set range.

## Rack position chart for special cooking options

Mode	Rack position
Keep Warm	2
Steam Proof	2 or 3
Stone Bake Mode	1 or 2
Dehydrate	3 or 4

## Using the smart control feature (Lower oven only)

To use the oven's Smart Control, you must download the SmartThings app to a mobile device. Functions that can be operated using the SmartThings app may not work smoothly if communication conditions are poor or the oven is installed in a place with a weak Wi-Fi signal.

Please refer to the following table for the main functions that can be operated from the app.

When Smart Control on the oven is off	Monitoring (Oven, Probe), Oven off
When Smart Control on the oven is on.	Monitoring (Oven, Probe), Oven start, Oven off, Error check

## How to connect the oven

1. Download and open the SmartThings app on your smart device.
2. Follow the app's on-screen instructions to connect your oven.
3. Once the process is complete, the connected  icon located on your oven displays and the app will confirm you are connected.
4. If the connection icon does not turn on, follow the instruction in the app to reconnect.

## To start the oven remotely



Tap the Smart Control on the screen.  
The oven can now be started and controlled remotely by a connected mobile device.

### When Smart Control is on you can:

- Remotely change oven settings (mode, time, temperature) using your mobile device.
- Remotely start the oven.
- Remotely turn off the oven.
- Once cooking starts, you can change the cooking time and temperature remotely.

### NOTE

- **Important:** Self Clean mode cannot be started remotely.
- This appliance is configurable to allow remote operation at any time. Do not store any flammable materials or temperature sensitive items inside, on top or near surface units of the appliance.
- When Smart Control is deactivated, you can still monitor the oven's status and turn the oven off.
- When oven cooking is finished or cancelled, Smart Control will be deactivated.

## Bixby

- Bixby is the name of Samsung's artificial intelligence solution that makes it possible to control the product by voice.
- To use the voice recognition function, you need to connect the SmartThings app and the product on your smartphone.
- For models that do not directly recognize voice input for the product after connecting to the app, some functions can still be controlled through Bixby on Samsung smartphones.

## Amazon Alexa & Google Assistant

Samsung smart home appliances are supported by SmartThings skill in Alexa and Action in Google Assistant.

## Installation Guide

Here's how to link SmartThings account into Amazon Alexa or Google Assistant. SmartThings App and Alexa App (or Google Assistant App) should be installed on your phone.

1. Setup supported devices on SmartThings
2. After device setup, tap **'Voice assistant'** and link your Samsung account to Amazon Alexa.
3. Check to see if the devices are visible on Amazon Alexa app. If visible, account linking is complete. (Check that the devices are visible and set the location (home & room) of devices in Google home app. Then account linking is complete.)

# Oven (Lower Oven)

## Using the oven racks

### Oven rack positions (single mode)

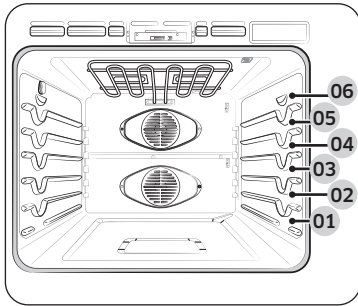

Recommended rack positions for cooking

TYPE OF FOOD	RACK POSITION
Broiling hamburgers	6
Broiling meats or small cuts of poultry, fish	3 - 5
Bundt cakes, pound cakes, frozen pies, casseroles	4 or 3
Angel food cakes, small roasts	2
Turkeys, large roasts, hams, fresh pizza	1

- This table is for reference only.

### Oven rack positions with divider (twin mode)

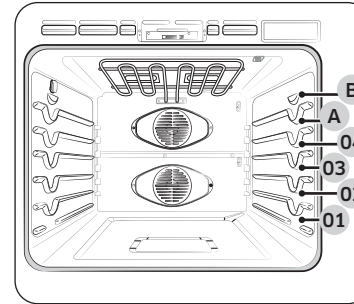

The upper compartment has 2 rack positions (A, B).

The lower compartment has 3 rack positions (1 - 3).

TYPE OF FOOD	RACK POSITION	
	Upper	Lower
Frozen pies	A	1
Angel food cakes	-	1
Bundt or pound cakes	-	1
Muffins, brownies, cookies, cupcakes, layer cakes, Pies, Biscuits	A	1
Casseroles	A	1
Small roast, hams	A	1
Small turkeys, medium roasts	-	1

- This table is for reference only.

## Rack and Pan placement

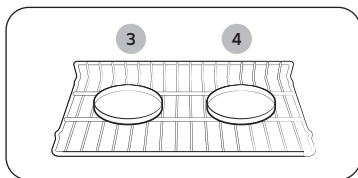

Single Oven Rack

Centering baking pans in the oven as much as possible will produce better results. If baking with more than one pan, place the pans so each has at least 1" to 1½" of air space around it.

When baking on a single oven rack, place the oven rack in **position 3** or **4**. See the figure on the left.

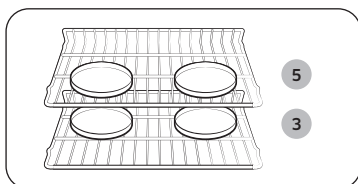

Multiple Oven Racks

When baking cakes and cookies on multiple racks, place the oven racks in **positions 3** and **5**.

### Using multiple oven racks

Type of Baking	Rack Positions
Cakes and cookies	3 and 5

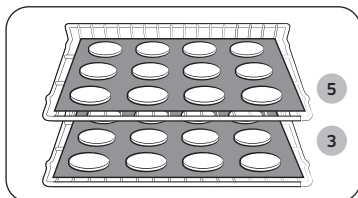

Multiple Oven Racks

## Before using the racks

Each rack has stops that need to be placed correctly on the supports. These stops will keep the rack from coming completely out.

### Removing the racks

1. Pull the rack straight out until it stops.
2. Lift up the front of the rack, and then pull it out.

### Replacing the racks

1. Place the end of the rack on the support.
2. Tilt the front end up and push the rack in.

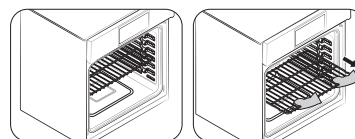

### ⚠ CAUTION

- Do not cover a rack with aluminum foil or place aluminum foil on the oven bottom. This will hamper heat circulation, resulting in poor baking, and may damage the oven bottom.
- Arrange the oven racks only when the oven is cool.

# Oven (Lower Oven)

## Using the gliding rack

The fully extendable Gliding rack makes food preparation easier, especially when you are preparing heavier dishes. The Gliding rack has 2 glide tracks that allow you to extend the rack well out of the oven without touching the sides of the oven walls.

### Installing the Gliding rack

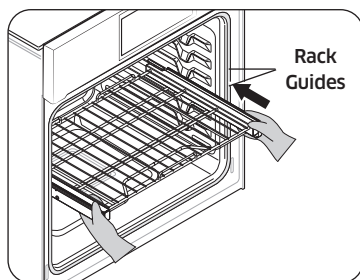

With the Gliding rack in the Closed position and the oven off, carefully insert the Gliding Rack between the guides until the rack reaches the back.

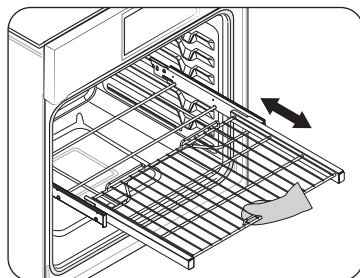

When using the Gliding rack in the oven, be sure to pull on the handle of the rack only to slide it in and out. If you grasp the frame while using the rack, the entire Gliding rack will be removed. Make sure you use oven gloves when handling the Gliding rack during cooking.

### Removing the Gliding rack

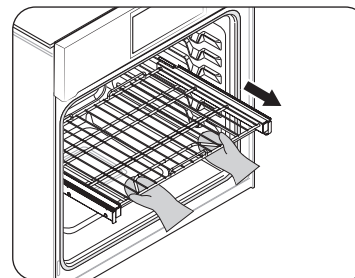

With the Gliding rack in the Closed position and the oven off and cool, grasp the rack and frame and pull both forward to remove.

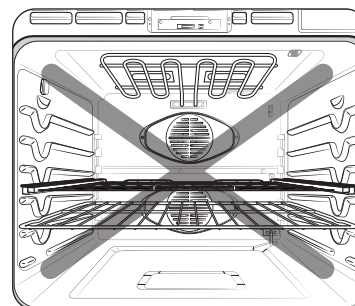

### ⚠ CAUTION

Do not install the Gliding rack directly above the Wire rack. You will not be able to install it properly and the rack could fall.

### 📖 NOTE

You can install the Gliding rack in any rack positions except the lowest rack position in the oven(level 1).



---

## Using the divider

---

- To use twin mode operation, insert the divider.
- Handle the divider with both hands.
- Use oven gloves when inserting or removing the divider.

### To Install the Divider into the Oven Cavity

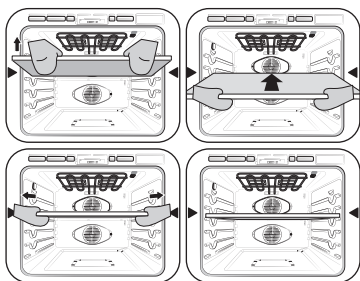

1. Insert the divider into the 4th rack position of the cavity.
2. Push the divider in until its back end rests against the back of the cavity.

#### CAUTION

If the oven displays **-dC-**

- Check the divider to see if it is installed correctly.

---

## Using the clean feature

---

The Clean feature has four selections: Self-Clean, Steam-Clean, Descale, and Draining.

### Self Clean

This self-cleaning oven uses high temperatures (well above cooking temperatures) to burn off leftover grease and residue completely or reduce them to a finely powdered ash that you can wipe away with a damp cloth.

#### CAUTION

- During the self-cleaning cycle, the outside of the oven will become very hot to the touch. **Do not** leave small children unattended near the appliance.
- Some birds are extremely sensitive to the fumes given off during the self-cleaning cycle of any oven. Move birds to another well-ventilated room.
- **Do not** line the oven walls, racks, bottom, or any other part of the oven with aluminum foil. Doing so will result in poor heat distribution, poor baking results, and cause permanent damage to the oven interior. Aluminum foil will melt and adhere to the interior surface of the oven.
- The oven door locks during self-cleaning. **Do not** force the oven door open. This can damage the automatic door locking system. Use care when opening the oven door after the self-cleaning cycle is complete. Stand to the side of the oven when opening the door to allow hot air or steam to escape. The oven may still be **VERY HOT**.

# Oven (Lower Oven)

## Before a self cleaning cycle

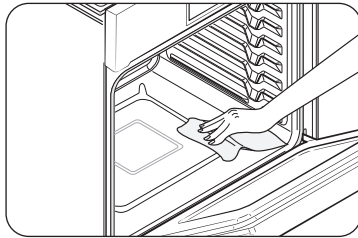

Fig. 1

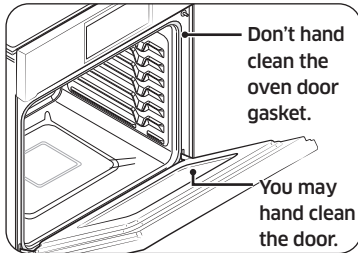

Fig. 2

- We recommend venting your kitchen with an open window or using a ventilation fan or hood during the self-cleaning cycle.
- Remove the wire rack, broil pan, broil pan insert, all cookware, and any aluminum foil from the oven.
- Wipe up debris from the oven bottom.
- The silver-colored oven racks can be self-cleaned, but they will darken, lose their luster, and become hard to slide.
- Residue on the front frame of the oven and outside the gasket on the door will need to be cleaned by hand. Clean these areas with hot water, soap-filled steel-wool pads, or cleansers such as Soft Scrub. Rinse well with clean water and dry.
- Do not clean the gasket. The fiberglass material of the oven door gasket cannot withstand abrasion. It is essential for the gasket to remain intact. If you notice it becoming worn or frayed, have it replaced. (Fig. 2)
- Make sure the oven light cover is in place and the oven light is off.

### NOTE

Remove oven racks and accessories before starting the self-clean mode.

## How to run a self cleaning cycle



1. Swipe the screen to **Clean**. The display will show 4 cleaning selections.



2. Tap **Self Clean**.

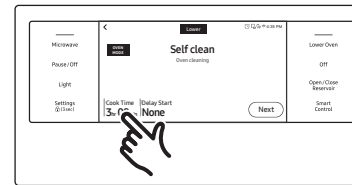

3. Tap **Clean Time**.

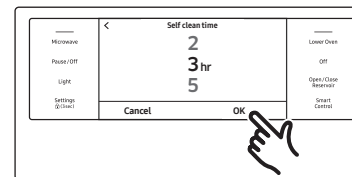

4. Flick the screen to set the clean time. You can choose 2 hours, 3 hours, or 5 hours. (The default is 3 hr).
5. Tap **OK**.



6. If you don't want to use the Delay Start feature, go to Step 8. Otherwise, tap **Delay Start**, and then go to Step 7.

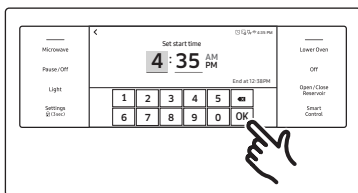

- Set the time you want self-cleaning to start, and then tap **OK**.

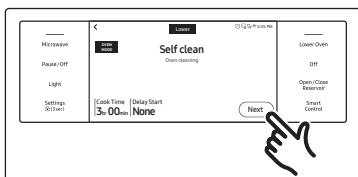

- Tap **Next**.



- Press the **Smart Control** for 3 seconds to begin self-cleaning. The motor-driven door lock will engage automatically.



- If you need to stop or interrupt a self cleaning cycle, tap **Off**.

#### NOTE

- You will not be able to start a self-cleaning cycle if the control lockout feature is activated or if the oven's temperature is too hot.
- The oven doors lock automatically. The display will show the cleaning time remaining. You cannot open the oven doors until the temperature drops to a safe/cool temperature.
- The self-clean feature can be used in only one oven at a time. While one oven is in selfcleaning mode, you cannot use the other oven for cooking.
- Clean the transparent cover of the camera and the upper LED glass regularly to monitor through the camera. If there are severe stains on these parts, perform pyrolytic cleaning and then wipe them by using a scouring pad.
- Do not clean it with a stainless steel spiral pad. It may cause scratches or other damage to the lens.

#### After a self-cleaning cycle

- You may notice some white ash in the oven. Wipe it up with a damp cloth after the oven cools. (If white spots remain, remove them with a soap-filled steel wool pad and rinse thoroughly with a vinegar and water mixture.)
- If the oven is not clean after one cycle, repeat the cycle.
- You cannot set the oven for cooking until the oven is cool enough for the door to unlock.

# Oven (Lower Oven)

## Steam-Cleaning

### How to set the oven for steam-cleaning

For light cleaning, the steam-cleaning function saves time and energy. For heavier duty cleaning, use the self-cleaning function.



1. Swipe the screen to **Clean**. The display will show 4 cleaning selections.



2. Tap **Steam Clean**.



3. Remove all accessories from the oven. Tap **Start**.

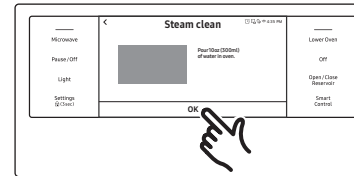

4. Pour approximately 10 oz. (300 ml) of water onto the bottom of the empty oven and then close the oven door. Use normal water only, not distilled water. Tap **OK** to begin steam-cleaning. The motor-driven door lock will engage automatically.

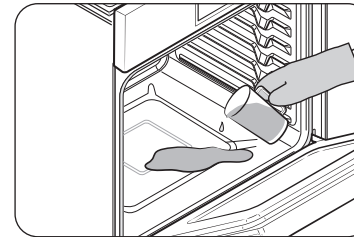

- **Important** : Both doors lock when you run a steam cleaning cycle on either oven.

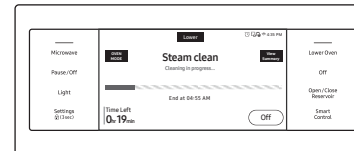

5. If you need to stop or interrupt a steam cleaning cycle, tap **Off**.

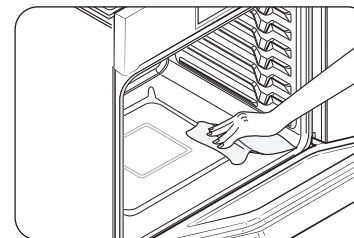

6. Clean the oven's interior. There will be a significant amount of water remaining on the bottom of the oven after a steam-cleaning cycle. Remove the residual water with a sponge or soft dry cloth.

## ⚠ CAUTION

Wear gloves during cleaning.

### After a steam-cleaning cycle

- Use caution when opening the door before a steam-cleaning procedure has ended. The water on the bottom is hot.
- Open the oven door and remove the remaining water with a sponge. Do not leave the residual water in the oven for any length of time. Wipe the oven clean and dry with a soft cloth. Do not forget to wipe under the oven door seal.
- Use a detergent-soaked sponge, a soft brush, or a nylon scrubber to wipe the oven interior. Remove stubborn residue with a nylon scourer. You can remove lime deposits with a cloth soaked in vinegar.
- If the oven remains dirty, you can repeat the procedure once the oven has cooled.
- For heavy residue, such as grease left over from roasting, we recommend that you rub detergent into the residue before activating the steam-cleaning function.
- After cleaning, leave the oven door ajar at a 15° angle to allow the interior enamel surface to dry thoroughly.

### Descal

If you use Steam Bake or Steam Roast functions frequently, we recommend descaling regularly to remove minerals from the oven that may affect the taste or quality of food cooked. When running a descaling cycle, use only descaling agents that are specific to steam ovens or coffee machines.

## 📖 NOTE

If you use Steam Bake or Steam Roast functions for more than a total of 12 hours, the Descal indicator turns on. You can still enable the Steam Bake or Steam Roast functions for the next two hours without descaling. However, after those two hours are up, the Steam Bake or Steam Roast functions will be disabled until you run a descaling cycle.

### How to run a descale cycle

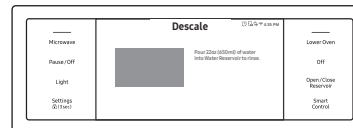
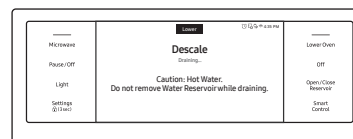
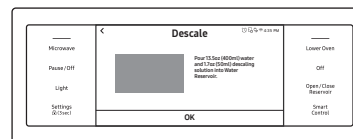
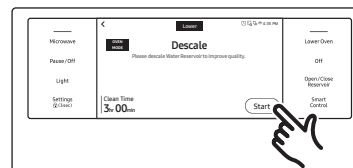

1. Swipe the screen to **Clean**. The display will show 4 cleaning selections.
2. Tap **Descal**.
3. Tap **Start**.
4. Follow the on-screen instructions. It takes 3 hours to complete the cycle.
  - Empty and clean the water reservoir, and then fill it with 1.7 oz (50 ml) of descaling agent and 13.5 oz (400 ml) of drinkable water.
5. When descaling is complete, the oven drains water automatically.
6. Use oven gloves to remove and empty the water reservoir, and then refill it with 22 oz (650 ml) of drinkable water for rinsing.
7. Follow the on-screen instructions, and then tap **OK** to start rinsing.

# Oven (Lower Oven)

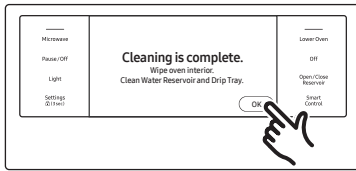

8. When rinsing is complete, use oven gloves to empty and clean the water reservoir.

## ⚠ WARNING

Use only descaling agents that are specific to steam ovens or coffee machines.

## ⚠ CAUTION

- Running the Descaling function disables Steam Bake and Steam Roast. Do not cancel descaling while it is in process. If you stop it, you must restart the descaling cycle and complete it within the next three hours to re-enable the Steam Bake and Steam Roast functions.
- To avoid accidents, keep children away from the oven.
- For the correct ratio of water to descaling agent, follow the agent manufacturer's instructions. If the ratio of water to descaling agent differs from the instructions here (8 to 1), use the ratio indicated in the instructions for the descaling agent.

## 📖 NOTE

Although the oven automatically starts descaling in 5 seconds without your confirmation, we recommend that you confirm your selection. This is to prevent descaling from starting by mistake.

## Draining

When a steam function is complete, you must drain the remaining water to prevent the water from affecting other cooking modes.

To drain the water, follow these steps:

## How to run a draining

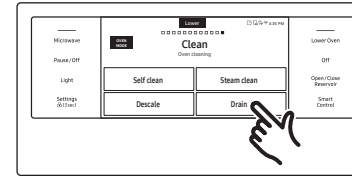

1. Swipe the screen to **Clean**. The display will show 4 cleaning selections.
2. Tap **Draining**.



3. Tap **Start**.

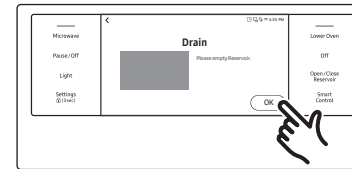

4. Prior to draining, empty the water reservoir to prevent overflow. Tap **OK**. The oven drains water from the steam generator to the water reservoir.

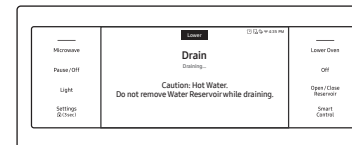

5. When draining is complete, use oven gloves to remove and empty the water reservoir.



## 📖 NOTE

Once the oven starts draining, wait until the draining cycle is complete.

## Settings

In Settings, you can change the default settings to your preference or diagnose problems with the network connection.



Tap **Settings**. The display will show the Setting item.

### Wi-Fi

To enable a Wi-Fi connection

1. Tap **Settings** > **Connections** > **Wi-Fi**, and then tap **On** in the right screen.
2. Tap **Wi-Fi**, and then tap a Wi-Fi network in the list that appears.
3. You will be prompted to provide a password for a secure network. Enter the password.

To manually input an IP

1. Tap **Settings** > **Connections** > **Wi-Fi**, and then tap **On** in the right screen.
2. Tap **Wi-Fi**, and then tap **Add Network**.
3. Enter an IP manually, and then tap **Connect** to apply your settings.

### NOTE

- To disable a Wi-Fi connection, Tap **Settings** > **Connections** > **Wi-Fi**, and then tap **Off** in the right screen.
- For details about the Wi-Fi connection and using the SmartThings app, see the SmartThings app user manual.

## Display

### 1. Brightness

You can change the brightness of the display screen.

- Tap **Settings** > **Display** > **Brightness**, and then use the bar next to Brightness to adjust the brightness of the screen.

### 2. Screen saver

If screen saver is turned off, the Clock theme and Timeout menu are disabled.

- Tap **Settings** > **Display** > **Screen saver**, and then tap **Off** in the right screen.

### 3. Clock theme

- Tap **Settings** > **Display** > **Clock theme**, and then tap in the right screen. You can select a theme.

### 4. Timeout

- Tap **Settings** > **Display** > **Timeout**, and then tap in the right screen. You can select a time from 5 minutes to 60 minutes, or Always on.

## Date & Time

To enable automatic date and time

1. Turn on the Wi-Fi connection.
2. Tap **Settings** > **Date & Time** > **Automatic date and time**, and then tap **On** in the right screen. The date and time are set automatically.

To manually input date and time

1. Tap **Settings** > **Date & Time** > **Automatically date and time**, and then tap **Off** in the right screen. Time zone, set date, and set time are activated.
2. You can set the time zone, date, and time.

To change the time format

1. Tap **Settings** > **Date & Time** > **Select time format**, and then tap in the right screen.
2. You can select 12-hour clock or 24-hour clock.

# Oven (Lower Oven)

## Language

Choose a display language.

1. Tap **Settings** > **Language**, and then tap in the right screen.
2. You can select English, Spanish, or French.

## Volume

Adjust the volume level for beeps and melodies.

- Tap **Settings** > **Volume**, and then use the bar next to Volume to adjust the volume.

## Temperature

1. Temperature unit

You can program the oven control to display the temperature in Fahrenheit or Celsius. The oven has been preset at the factory to display in Fahrenheit.

- Tap **Settings** > **Temperature** > **Temperature unit**, and then tap in the right screen. You can select °C or °F.

2. Temperature adjust

The temperature in the oven has been calibrated at the factory. When first using the oven, be sure to follow recipe times and temperatures.

If you think the oven is too hot or too cool, you can correct the temperature in the oven. Before correcting, test a recipe by using a temperature setting that is higher or lower than the recommended temperature.

The baking results should help you to decide how much of an adjustment is needed. The oven temperature can be adjusted  $\pm 35$  °F ( $\pm 19$  °C).

- Tap **Settings** > **Temperature** > **Temperature Adjust**, and then tap in the right screen. You can increase or decrease the temperature by 35 °F (19 °C).

## NOTE

- This adjustment will not affect the broiling or the self-cleaning temperatures.
- The adjustment will be retained in memory after a power failure.

## 12 hour energy Saving

If you accidentally leave the oven on, this feature will automatically turn off the oven after 12 hours during baking functions or after 3 hours during a broil function.

1. Tap **Settings** > **12 hour Energy Saving**, and then tap **On** in the right screen.
2. The 12 hour energy saving icon will appear in the indicator area.

## Easy connection

Easy connection enables you to easily configure the network settings including the authentication procedure.

- Tap **Settings** > **Connections** > **Easy Connection**, and then tap **Connect**.

## Help

Help provides useful tips and explanations on a specific item that you select.

1. Troubleshooting
  - Tap a checkpoint directly on the screen, and try the suggestions.
2. Guide for first use
  - Provides simple instructions on the basic use of the oven.

## About device

You can see information about the oven and do a software update.

To update the software:

1. Tap **Settings** > **About device** > **SW update**, and then tap **Update** in the right screen.
2. Tap **Install**. The software is updated and the system restarts automatically.

## Sabbath

You can set Sabbath mode. See the **Using the sabbath feature** section on the next page.



---

### Demo mode

This option is for use by retail establishments for display purposes only. (The heating element does not operate.)

1. Set the time to 12:34.
2. Tap **Settings** and **Smart Control** at the same time for 5 seconds.
3. The Demo mode indicator appears on screen.

### Factory reset

You can reset your oven setting.

1. Tap **Settings** > **Factory reset**, and then tap **Reset** in the screen.
2. SAMSUNG logo appears on the screen and the oven resets.

#### CAUTION

Before reset the oven settings, turn off all oven functions.

### Remote Management

The call center will access your product remotely to check internal when you have some problems.

- Tap **Settings** > **Connections** > **Remote management**, and then tap **Activate**.

---

### Using the sabbath feature

(For use on the Jewish Sabbath & Holidays)



For further assistance, guidelines for proper usage, and a complete list of models with the Sabbath feature, please visit the web at <http://www.star-k.org>.

You can use the Sabbath feature with baking only. The oven temperature may be set higher or lower after you set the Sabbath feature. (The oven temperature adjustment feature should be used only during Jewish holidays.) The display, however, will not change and tones will not sound when a change occurs. Once the oven is properly set for baking with the Sabbath feature active, the oven will remain on continuously until the Sabbath feature is cancelled. This will override the factory preset 12 hour energy saving feature. If the oven light is needed during the Sabbath, touch Light before activating the Sabbath feature. Once the oven light is turned on and the Sabbath feature is active, the oven interior light will remain on until the Sabbath feature is turned off. If the oven light needs to be off, be sure to turn the oven light off before activating the Sabbath feature.

# Oven (Lower Oven)

## How to use the Sabbath feature



1. Swipe the screen to **Bake** mode.



2. Set the temperature and cook time you want.
3. Tap **Start**.

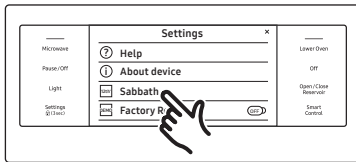

4. Tap **Settings** > **Sabbath**, and then tap **Sabbath** to use the Sabbath feature. The oven will not beep or display any further changes. You may change the oven temperature once baking has started. Remember that the oven will not beep or display any further changes once the Sabbath feature is engaged.

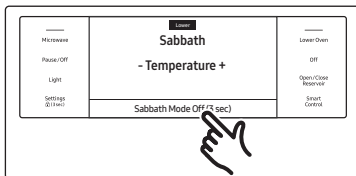

5. You can turn the oven off at any time by touching **Off**. Note that this does not turn Sabbath mode off.
6. To turn Sabbath mode off, touch and hold **Sabbath Mode Off** for 3 seconds.

## ⚠ CAUTION

- You can change the oven temperature, but the display will not change and tones will not sound when a change occurs. (The oven temperature adjustment feature should be used only on Jewish holidays.) After you change the temperature while the unit is in Sabbath mode, there is a 15 second delay before the unit recognizes the change.
- You can set the Cook Time function before activating the Sabbath feature.
- Should you experience a power failure or interruption, the oven will shut off. When power is returned, the oven will not turn back on automatically. **Sabbath** will be displayed in the oven control display, but the oven will not operate. Food may be safely removed from the oven while it is still in the Sabbath mode, however the oven cannot be turned back on until after the Sabbath Holidays. After the Sabbath observance, turn off the Sabbath mode. Touch and hold **Sabbath Mode Off** for 3 seconds.

## 📖 NOTE

- Do not attempt to activate any other program feature except Bake while the Sabbath feature is active.
- Do not open the oven door or change the oven temperature for about 30 minutes after you have started Sabbath mode to allow the oven to reach the set temperature. Note that for best performance, the oven fan operates only when the oven temperature is rising.

# Maintaining your appliance

## Care and cleaning of the oven

### Cleaning painted parts and decorative trim

- For general cleaning, use a cloth with hot, soapy water.
- For more difficult residue and built-up grease, apply a liquid detergent directly onto the area and leave for 30 to 60 minutes. Wipe with a damp cloth and dry. Do not use abrasive cleaners on any oven surface. They can be scratched.

### Cleaning stainless steel surfaces

1. Shake a bottle of Stainless Steel Appliance Cleaner or Polish well.
2. Place a small amount of stainless steel appliance cleaner or polish on a damp cloth or damp paper towel.
3. Clean a small area, rubbing with the grain of the stainless steel if applicable.
4. Dry and buff with a clean, dry paper towel or soft cloth.
5. Repeat as necessary.

#### NOTE

- **Do not use a steel-wool pad. It will scratch the surface.**
- If a mineral oil-based stainless steel appliance cleaner has been used before to clean the appliance, wash the surface with dishwashing liquid and water prior to using the Stainless Steel Appliance Cleaner or Polish.

### Air fry tray

To keep the Air fry tray clean, remove them from the cavity, and soak them in Lukewarm soapy water. Then, scour soil off of the Air fry tray using a plastic scouring pad.

#### NOTE

The air fry tray is dishwasher-safe.

#### CAUTION

Do not leave the air fry tray in the oven during the self-cleaning cycle. The extreme heat generated in this cycle permanently peel off the air fry coating, their color will turn slightly blue and finish will be dull.

### Oven racks

- If the racks are left in the oven during a self-cleaning cycle, their color will turn slightly blue and the finish will be dull. After the self-cleaning cycle is complete and the oven has cooled, rub the sides of the racks with wax paper or a cloth containing a small amount of oil. This will help the racks glide more easily on their tracks.
- Gliding racks may be cleaned by hand with an abrasive cleaner or steel wool. During cleaning, be careful not to allow water or cleaner to enter the slides on the sides of rack.

#### NOTE

- Do not clean in a dishwasher.
- If the rack becomes hard to remove or replace, lightly wipe the oven rack guides with cooking oil. Do not wipe cooking oil on the slides.
- If the rack becomes difficult to slide, the rack may need to be lubricated using a graphite lubricant.
- To order graphite lubricant, call Samsung customer care at 1-800-SAMSUNG (726-7864) or visit our homepage ([www.samsung.com/us/support](http://www.samsung.com/us/support), [www.samsung.com/ca/support](http://www.samsung.com/ca/support), or [www.samsung.com/ca\\_fr/support](http://www.samsung.com/ca_fr/support)) and search for part number DG81-01629A.
- If you want to buy directly, go to <http://www.samsungparts.com>.

# Maintaining your appliance

## To lubricate the slides of the gliding rack

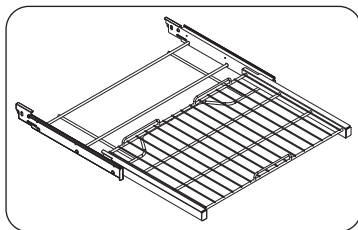

1. Remove the rack from the oven. See removing the gliding rack in the **Using the gliding rack** section on page 64.
2. Fully extend the rack on a table or countertop. Newspaper may be placed underneath the rack for easy cleanup.

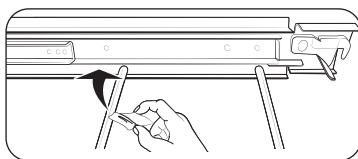

3. If there is debris in the slide tracks, wipe it away using a paper towel. (Any graphite lubricant wiped away must be replaced - See steps 4 through 7).

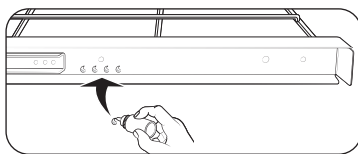

4. Shake the graphite lubricant before opening it. Starting with the left (front and back) slide mechanism of the rack, place four (4) small drops of lubricant on the two (2) bottom tracks of the slide close to the bearing carriers.

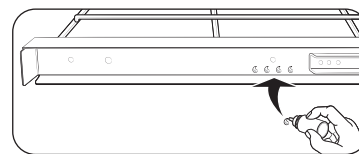
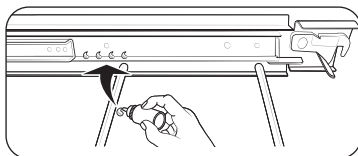

5. Repeat for the right (front and back) slide mechanism of the rack.
6. Open and close the rack several times to distribute the lubricant.
7. Replace the cap on the lubricant and shake it again. Turn the rack over and repeat steps 3, 4, 5, and 6.
8. Close the rack, turn the rack right-side-up, and then place in oven. See **Installing the Gliding rack** on page 64.

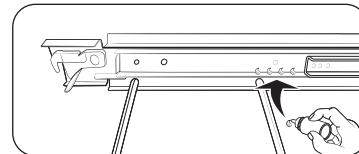

### NOTE

Do not spray the gliding rack with cooking spray or other lubricant sprays.

## Oven door

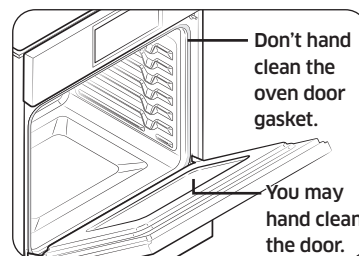

- Use soap and water to thoroughly clean the top, sides, and front of the oven door. Rinse well. You may use a glass cleaner on the outside glass of the oven door. **DO NOT immerse the door in water. DO NOT spray or allow water or the glass cleaner to enter the door vents.** **DO NOT** use oven cleaners, cleaning powders, or any harsh abrasive cleaning materials on the outside of the oven door.
- **DO NOT clean the oven door gasket.** The oven door gasket is made of a woven material which is essential for a good seal. Care should be taken not to rub, damage, or remove this gasket.

## Removing the oven door (Lower oven only)

### ⚠ CAUTION

- The door is very heavy. Be careful when removing and lifting the door.
- Use two hands to remove an oven door. For double ovens, repeat the process for each door.

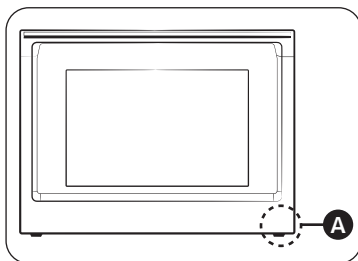

A. Wire Harness

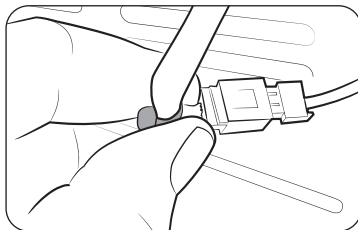

1. Prior to removing the oven door, prepare a surface where you will place it. This surface should be flat and covered with a soft blanket. You can also use the corner posts from your packaging material.
2. Remove the rubber cap and then disconnect the LED light's Wire Harness from the bottom right of the door.

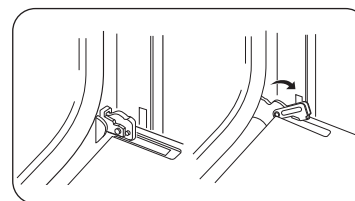

- A. Oven door hinge lock in locked position
- B. Oven door hinge lock in unlocked position

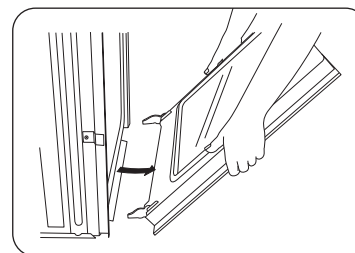
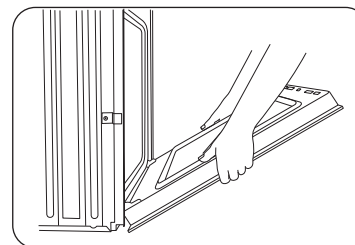

3. Open the oven door.
4. Locate the oven door hinge locks in both corners of the oven door, and then rotate the hinge locks toward the oven door to the unlocked position. If the door hinge lock is not rotated fully (see illustration B on the left for an example of full rotation), you will not be able to remove the door properly.
5. Partially close the door to engage the door latch locks. The door will stop at this point.
6. Using two hands, grasp the edges of the oven door. Lift and pull the oven door toward you and remove. You may need to gently shift the door from side to side as you pull.
7. Set the oven door aside on the prepared covered work surface with the oven door resting on its handle.

# Maintaining your appliance

## Replacing the oven door (Lower oven only)

### ⚠ CAUTION

The door is very heavy. You may need help lifting the door high enough to slide it into the hinge slots. Do not lift the door by the handle.

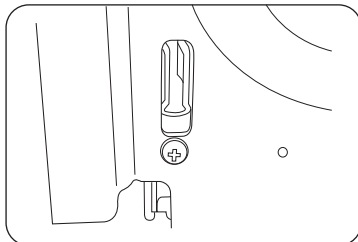

A. Slot in the oven cavity for the door hinge lock

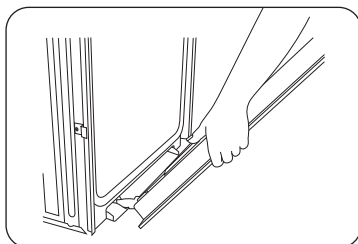

1. Using two hands, grasp the side edges of the door at the midpoint. Face the oven cavity.
2. Locate the slots on each side of the oven cavity for the door hinge locks.
3. Hold the door at a 45 ° angle, and then align the door hinges with the slots in the lower front of the oven cavity. Slowly insert the door, making sure you maintain the 45 ° angle. You will know the door is engaged in the slot when you feel a slight drop.

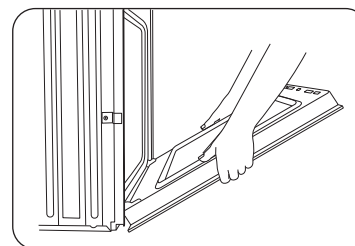

4. Lower the oven door to the fully open position. If the oven door does not open to a full 90 °, repeat steps 1 through 3.
5. Locate the oven door hinge locks in the corners of the oven door, and rotate the hinge locks toward the oven cavity to the locked position. See Step 3 (illustration A) in the **Removing the oven doors** section for the proper locked position.
6. Close the oven door.
7. When the hinges are properly installed and the door is closed, there should be an even gap between the door and the control panel. If one side of the oven door is hanging lower than the other, the hinge on that side is not properly installed.
8. Reconnect the LED light's Wire Harness and re-insert the rubber.

### ⚠ CAUTION

After replacing the door, make sure to reconnect the wires. Push them inward to arrange them as they were before you removed the door. Wires that are not connected or arranged correctly can be caught in the door or damaged by heat.

## Changing the oven light (Lower oven only)

The oven light is a standard 40-watt appliance halogen bulb. It comes on when the oven door is open. When the oven door is closed, touch **Light** to turn the light on or off. It will not work during a self-cleaning cycle.

### ⚠ CAUTION

Before changing the oven light, make sure to wear gloves to protect your hands.

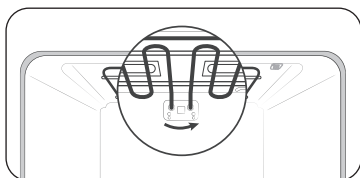

1. To change the halogen bulb, you must tilt the broil heater down. To do this, turn the circular nut on the support counterclockwise while holding the broil heater. The broil heater should loosen and tilt down.

### ⚠ CAUTION

The broil heater is not a removable part. Do not force the broil heater down. Do not let it drop down.

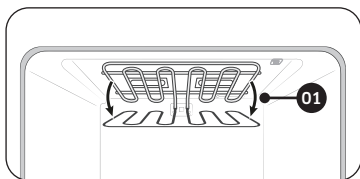

2. While holding the glass cover with one hand, insert a flat-sharp tool such as a table knife between the glass and the frame to remove the glass cover.

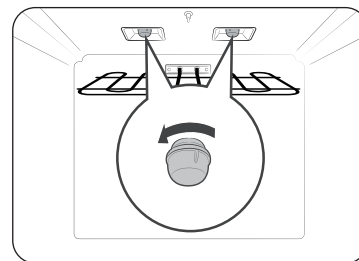
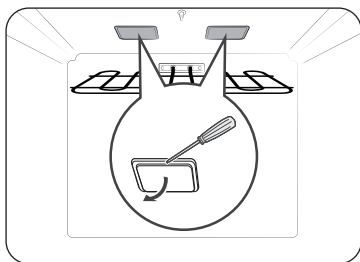

3. Turn the bulb cap counterclockwise to remove.

### 📖 NOTE

If necessary, remove the metal rings and clean the bulb cap.

4. Replace the bulb.
5. Place the bulb cap and glass cover back into their position.
6. Return the broil heater back by following step 1 in reverse order.

### ⚠ CAUTION

Before changing your oven light, disconnect the electrical power to the oven at the main fuse or circuit breaker panel. Make sure the oven and the halogen bulb are cool.

# Troubleshooting

At Samsung we want to ensure that you don't have problems with your new electric oven. If you run into unexpected trouble, look first for a solution in the tables below. If you're still having trouble after trying the suggested solution, call Samsung at 1-800-SAMSUNG (1-800-726-7864).

## Control Display

Problem	Possible cause	Solution
The display goes blank.	A fuse in your home may be blown or the circuit breaker tripped.	Replace the fuse or reset the circuit breaker.
The buttons cannot be pressed properly.	<ul style="list-style-type: none"> <li>There is foreign matter caught between the buttons</li> <li>Touch model: There is moisture on the exterior</li> <li>The lock function is set</li> </ul>	<ul style="list-style-type: none"> <li>Remove the foreign matter and try again.</li> <li>Remove the moisture and try again.</li> <li>Check whether the lock function is set.</li> </ul>

## For the Microwave Oven

Symptom	Cause	Action
<b>General</b>		
The buttons cannot be pressed properly.	Foreign matter may be caught between the buttons.	Remove the foreign matter and try again.
	For touch models: Moisture is on the exterior.	Wipe the moisture from the exterior.
	Child lock is activated.	Deactivate Child lock.
The oven does not work.	Power is not supplied.	Make sure power is supplied. Make sure the oven is plugged in. Check if a fuse has been blown or circuit breaker has been tripped.
	The door is open.	Close the door and try again.
	The door open safety mechanisms are covered in foreign matter.	Remove the foreign matter and try again.
The oven stops while in operation.	The user has opened the door to turn food over.	After turning over the food, press the <b>Start</b> button again to start operation.



Symptom	Cause	Action
The power turns off during operation.	The oven has been cooking for an extended period of time.	After cooking for an extended period of time, let the oven cool.
	The cooling fan is not working.	Listen for the sound of the cooling fan.
	Trying to operate the oven without food inside.	Put food in the oven.
	There is insufficient ventilation space for the oven.	There are intake/exhaust outlets on the front and rear of the oven for ventilation. Keep the gaps specified in the product installation guide.
	Several power plugs are being used in the same socket.	Designate only one socket to be used for the oven.
There is a popping sound during operation, and the oven doesn't work.	Cooking sealed food or using a container with a lid may cause popping sounds.	Do not use sealed containers as they may burst during cooking due to expansion of the contents.
The oven exterior is too hot during operation.	There is insufficient ventilation space for the oven.	There are intake/exhaust outlets on the front and rear of the oven for ventilation. Keep the gaps specified in the product installation guide.
	Objects are on top of the oven.	Remove all objects on the top of the oven.
The door cannot be opened properly.	Food residue is stuck between the door and oven interior.	Clean the oven and then open the door.

Symptom	Cause	Action
Heating including the Warm function does not work properly.	The oven may not work, too much food is being cooked, or improper cookware is being used.	Put one cup of water in a microwave-safe container and run the microwave for 1-2 minutes to check whether the water is heated. Reduce the amount of food and start the function again. Use a cooking container with a flat bottom.
The thaw function does not work.	Too much food is being thawed.	Reduce the amount of food and start the function again.
The interior light is dim or does not turn on.	The door has been left open for a long time.	The interior light may automatically turn off when the Eco function operates. Close and reopen the door or press the Cancel button.
	The interior light is covered by foreign matter.	Clean the inside of the oven and check again.
A beeping sound occurs during cooking.	If the Auto Cook function is being used, this beeping sound means it's time to turn over the food during thawing.	After turning over the food, press the <b>Start</b> button again to restart operation.
The oven is not level.	The oven is installed on an uneven surface.	Make sure the oven is installed on flat, stable surface.
There are sparks during cooking.	Metal containers are used during oven/thawing functions.	Do not use metal containers.

# Troubleshooting

Symptom	Cause	Action
When power is connected, the oven immediately starts to work.	The door is not properly closed.	Close the door and check again.
There is electricity coming from the oven.	The power or power socket is not properly grounded.	Make sure the power and power socket are properly grounded.
<ol style="list-style-type: none"> <li>1. Water drips.</li> <li>2. Steam is emitted through a door crack.</li> <li>3. Water remains in the oven.</li> </ol>	There may be water or steam in some cases depending on the food. This is not an oven malfunction.	Let the oven cool and then wipe with a dry dish towel.
The brightness inside the oven varies.	Brightness changes depending on power output changes according to function.	Power output changes during cooking are not malfunctions.
Cooking is finished, but the cooling fan is still running.	To ventilate the oven, the cooling fan continues to run for about 3 minutes after cooking is complete.	This is not an oven malfunction.

Symptom	Cause	Action
<b>Turntable</b>		
While turning, the turntable comes out of place or stops turning.	There is no roller ring, or the roller ring is not properly in place.	Install the roller ring and then try again.
The turn table drags while turning.	The roller ring is not properly in place, there is too much food, or the container is too large and touches the inside of the microwave.	Adjust the amount of food. Do not use containers that are too large.
The turn table rattles while turning and is noisy.	Food residue is stuck to the bottom of the oven.	Remove any food residue stuck to the bottom of the oven.
<b>Broiling</b>		
Smoke comes out during operation.	During initial operation, smoke may come from the heating elements when you first use the oven.	This is not a malfunction. After you run the oven 2-3 times, it should stop.
	Food is on the heating elements.	Let the oven cool and then remove the food from the heating elements.
	Food is too close to the grill.	Put the food a suitable distance away while cooking.
	Food is not properly prepared and/or arranged.	Make sure food is properly prepared and arranged.

Symptom	Cause	Action
Convection		
The oven does not heat.	The door is open.	Close the door and try again.
Smoke comes out during preheating.	During initial operation, smoke may come from the heating elements when you first use the oven.	This is not a malfunction. After you run the oven 2-3 times, it should stop.
	Food is on the heating elements.	Let the oven cool and then remove the food from the heating elements.
There is a burning or plastic smell when using the oven.	Plastic or non heat-resistant cookware is used.	Use glass cookware suitable for high temperatures.
There is a bad smell coming from inside the oven.	Food residue or plastic has melted and stuck to the interior.	Run the Steam Bake function for an hour, and then wipe with a dry cloth. You can put a lemon slice inside, and then run Steam Bake to remove the odor more quickly.

Symptom	Cause	Action
The oven does not cook properly.	The oven door is frequently opened during cooking.	If you open the door often, the interior temperature will be lowered and this may affect the results of your cooking.
	The oven controls are not correctly set.	Correctly set the oven controls and try again.
	The broil heater or other accessories are not correctly inserted.	Correctly insert the accessories.
	The wrong size or wrong type of cookware is used.	Use suitable cookware with flat bottoms.

### For the Lower Oven

Problem	Possible cause	Solution
The oven will not turn on.	The oven is not completely plugged into the electrical outlet.	Make sure the electrical plug is inserted into a live, properly grounded outlet.
	A fuse in your home may be blown or a circuit breaker may have tripped.	Replace the fuse or reset the circuit breaker.
	The oven controls have been set improperly.	See the <b>Basic operations</b> section starting on page 23.
	The oven is too hot.	Allow the oven to cool.
	Incomplete service wiring.	Call for service.
	Power outage.	Check to see if the house lights will turn on. If necessary, call your local electric company for service.

# Troubleshooting

Problem	Possible cause	Solution
The oven light will not turn on.	The light is loose or defective.	<ul style="list-style-type: none"> <li>Tighten or replace the lamp.</li> <li>Call for service if the door light does not turn on.</li> </ul>
	The switch operating the light is broken.	Call for service.
The oven smokes excessively during broiling.	The oven controls have not been set properly.	See the <b>Basic operations</b> section starting on page 23.
	The meat has been placed too close to the element.	Reposition the rack to provide proper clearance between the meat and the element. Preheat the broil element for searing.
	The meat has not been properly prepared.	Remove excess fat from the meat. Cut away fatty edges that may curl, leaving the lean intact.
	Grease has built up on oven surfaces.	Regular cleaning is necessary when broiling frequently.
Food does not bake or roast properly.	The oven controls have not been set correctly.	See the <b>Basic operations</b> section starting on page 23.
	The oven rack has been positioned incorrectly or is not level.	See the <b>Using the oven racks</b> section on page 62.
	The oven thermistor needs to be adjusted.	See <b>Temperature adjust</b> in the Settings section on page 72.

Problem	Possible cause	Solution
Food does not broil properly.	The serving size may not be appropriate.	Refer to the <b>Broiling recommendation guide</b> for serving sizes on page 49, and then try again.
	The rack has not been properly positioned.	See the <b>Broiling recommendation guide</b> on page 49.
	The cookware is not suited for broiling.	Use suitable cookware.
	In some areas, the power (voltage) may be low.	<ul style="list-style-type: none"> <li>Preheat the broil element for 10 minutes.</li> <li>See the <b>Broiling recommendation guide</b> on page 49.</li> </ul>
The oven temperature is too hot or too cold.	The oven thermistor needs to be adjusted.	See <b>Temperature adjust</b> in the Settings section on page 72.
There is water dripping.	You may see water or steam in some cases depending on the food you are cooking. This is not a product malfunction.	Let the oven cool and then wipe with a dry dish towel.
There is steam coming through the crack between the oven body and the door.		
Water remains in the oven.		

Problem	Possible cause	Solution
I can hear water boiling during steam cooking.	Water is being heated by the steam heater.	This is not a product malfunction.
The oven will not self-clean.	The oven temperature is too high to start a self-clean operation.	Allow the oven to cool and then reset the controls.
	The oven controls have been set incorrectly.	See the <b>Self Clean</b> section on page 65.
	A self-cleaning cycle cannot be started if the oven lockout feature has been activated.	Deactivate the oven control lockout (see page 24).
Excessive smoking during a self-cleaning cycle.	There is excessive soiling in the oven.	Press <b>Off</b> . Open the windows to rid the room of smoke. Wait until the self-cleaning cycle is cancelled. Wipe up the excessive soil and then start the self-cleaning cycle again.
The oven door will not open after a self-cleaning cycle.	The oven is too hot.	Allow the oven to cool.
The oven is not clean after a self-cleaning cycle.	The oven controls were not set correctly.	See the <b>Self Clean</b> section on page 65.
	The oven was heavily soiled.	Wipe up heavy spillovers before starting the self-cleaning cycle. Heavily soiled ovens may need to be self-cleaned again or for a longer period of time.

Problem	Possible cause	Solution
Steam is coming out of the vent.	When using the convection feature, it is normal to see steam coming out of the oven vent.	This is normal operation and not a system failure. Use the oven as usual.
	As the number of racks or amount of food being cooked increases, the amount of visible steam will increase.	
A burning or oily odor is coming from the vent.	This is normal for a new oven and will disappear in time.	<ul style="list-style-type: none"> <li>To speed the process, set a self-cleaning cycle for a minimum of 3 hours.</li> <li>See the <b>Self Clean</b> section on page 65.</li> </ul>
Strong odor.	An odor coming from the insulation around the inside of the oven is normal for the first few times the oven is used.	Operate the oven empty on the bake setting at 400 °F for 1 hour.
Fan noise.	A convection fan may automatically turn on and off.	This is not a system failure but normal operation.
The oven racks are difficult to slide.	The shiny, silver-colored racks were cleaned in a self-cleaning cycle.	Apply a small amount of vegetable oil to a paper towel, and then wipe the edges of the oven racks with the paper towel.
The oven door is locked.	The circuit breaker has been tripped or there was a power failure while the oven door was locked.	Activate Control Lockout, and then unlock the control. See the Oven Control Lockout section on page 24.

# Troubleshooting

## Information codes

Displayed Code	Possible cause	Solution
C-d0	This code occurs if the control key is short for 1 minute.	Clean the buttons and make sure there is no water on/ around them. Turn off the oven and try again. If the problem continues, contact a local Samsung service center.
C-d5	This code occurs if the door lock is mispositioned.	Press <b>Off</b> , and then restart the oven. If the problem persists, disconnect all power to the oven for at least 30 seconds and then reconnect the power. If this does not solve the problem, call for service.
C-F0	This code occurs if communication between the Main and Sub PBA is interrupted.	
C-F2	This code occurs if communication between the Main and Touch is interrupted.	
C-10	The cooking sensor is open when the microwave is operating.	
	The cooking sensor is short when the microwave is operating.	
C-20	The oven sensor is open when the oven is operating.	
	The oven sensor is short when the oven is operating.	
C-21	This code occurs if the internal temperature rises abnormally high.	

Displayed Code	Possible cause	Solution
C-23	The temp probe sensor is short when the oven is operating.	Press <b>Off</b> and then restart the oven. If the problem persists, disconnect all power to the oven for at least 30 seconds and then reconnect the power. If this does not solve the problem, call for service.
C-30	The PCB sensor is open when the oven is operating.	
		The PCB sensor is short when the oven is operating.
C-31	This code occurs if the PCB temperature rises abnormally high.	Call for service
-dC-	This code appears if the divider is inserted or removed while the oven is operating.	Make sure the divider is inserted properly, and then restart the oven. If the problem persists, disconnect all power to the oven for at least 30 seconds and then reconnect the power. If this does not solve the problem, call for service.
C-70	The steam sensor is open when the oven is operating	Press <b>Off</b> , and then restart the oven. If the problem persists, disconnect all power to the oven for at least 30 seconds and then reconnect the power. If does not solve the problem, call the service.
	The steam sensor is short when the oven is operating	
C-72	There are drain system-related problems.	
C-A2	The cooling motor is operating abnormally.	Call for service.

# Warranty (U.S.A)

**PLEASE DO NOT DISCARD. THIS PAGE REPLACES THE WARRANTY PAGE IN THE USE & CARE GUIDE**

## **SAMSUNG ELECTRIC OVEN**

### **LIMITED WARRANTY TO ORIGINAL PURCHASER WITH PROOF OF PURCHASE**

This SAMSUNG brand product, as supplied and distributed by SAMSUNG ELECTRONICS AMERICA, INC. (SAMSUNG) and delivered new, in the original carton to the original consumer purchaser, is warranted by SAMSUNG against manufacturing defects in materials or workmanship for the limited warranty period, starting from the date of original purchase, of:

#### **One (1) Year Parts and Labor Ten (10) Years Magnetron Part (Part Only)**

This limited warranty is valid only on products purchased and used in the United States that have been installed, operated, and maintained according to the instructions attached to or furnished with the product. To receive warranty service, the purchaser must contact SAMSUNG at the address or phone number provided below for problem determination and service procedures. Warranty service can only be performed by a SAMSUNG authorized service center. The original dated bill of sale must be presented upon request as proof of purchase to SAMSUNG or SAMSUNG's authorized service center to receive warranty service.

SAMSUNG will provide in-home service within the contiguous United States during the warranty period at no charge, subject to availability of SAMSUNG authorized servicers within the customer's geographic area. If in-home service is not available, SAMSUNG may elect, at its option, to provide transportation of the product to and from an authorized service center. If the product is located in an area where service by a SAMSUNG authorized servicer is not available, you may be responsible for a trip charge or required to bring the product to a SAMSUNG authorized service center for service.

To receive in-home service, product must be unobstructed and accessible to the service agent.

During the applicable warranty period, a product will be repaired, replaced, or the purchase price refunded, at the sole option of SAMSUNG. SAMSUNG may use new or reconditioned parts in repairing a product, or replace the product with a new or reconditioned product. Replacement parts and products are warranted for the remaining portion of the original product's warranty or ninety (90) days, whichever is longer. All replaced parts and products are the property of SAMSUNG and you must return them to SAMSUNG.

This limited warranty covers manufacturing defects in materials or workmanship encountered in normal household, noncommercial use of this product and shall not cover the following: damage that occurs in shipment, delivery, installation, and uses for which this product was not intended; damage caused by unauthorized modification or alteration of the product; product where the original factory serial numbers have been removed, defaced, changed in any way, or cannot be readily determined; cosmetic damage including scratches, dents, chips, and other damage to the product's finishes; damage caused by abuse, misuse, overheating due to overcooking, glass tray or turntable, pest infestations, accident, fire, floods, or other acts of nature or God; damage caused by use of equipment, utilities, services, parts, supplies, accessories, applications, installations, repairs, external wiring or connectors not supplied or authorized by SAMSUNG; damage caused by incorrect electrical line current, voltage, fluctuations and surges; damage caused by failure to operate and maintain the product according to instructions; in-home instruction on how to use your product; service to correct installation not in accordance with electrical or plumbing codes or correction of household electrical or plumbing (i.e., house wiring, fuses, or water inlet hoses); and reduced magnetron power output related to normal aging.

The cost of repair or replacement under these excluded circumstances shall be the customer's responsibility.

Visits by an authorized servicer to explain product functions, maintenance or installation are not covered by this limited warranty. Please contact SAMSUNG at the number below for assistance with any of these issues.

Samsung will charge a repair fee for replacing an accessory or repairing cosmetic damage if the damage to the unit and/or damage to or loss of the accessory was caused by the customer. Items this covers include:

- Dented, scratched, or broken door, handle, out-panel, or control panel
- Broken or lost tray, guide roller, coupler, filter, or wire rack

## Warranty (U.S.A)

Parts that SAMSUNG has determined can be replaced by the user may be sent to the customer for installation. In SAMSUNG's discretion, an authorized servicer can be dispatched to perform such installation.

### EXCLUSION OF IMPLIED WARRANTIES

IMPLIED WARRANTIES, INCLUDING THE IMPLIED WARRANTIES OF MERCHANTABILITY OR FITNESS FOR A PARTICULAR PURPOSE, ARE LIMITED TO ONE YEAR OR THE SHORTEST PERIOD ALLOWED BY LAW. Some states do not allow limitations on how long an implied warranty lasts, so the above limitations or exclusions may not apply to you. This warranty gives you specific rights, and you may also have other rights, which vary from state to state.

### LIMITATION OF REMEDIES

YOUR SOLE AND EXCLUSIVE REMEDY IS PRODUCT REPAIR, PRODUCT REPLACEMENT, OR REFUND OF THE PURCHASE PRICE AT SAMSUNG'S OPTION, AS PROVIDED IN THIS LIMITED WARRANTY. SAMSUNG SHALL NOT BE LIABLE FOR SPECIAL, INCIDENTAL OR CONSEQUENTIAL DAMAGES, INCLUDING BUT NOT LIMITED TO TIME WAY FROM WORK, HOTELS AND/OR RESTAURANT MEALS, REMODELING EXPENSES, LOSS OF REVENUE OR PROFITS, FAILURE TO REALIZE SAVINGS OR OTHER BENEFITS REGARDLESS OF THE LEGAL THEORY ON WHICH THE CLAIM IS BASED, AND EVEN IF SAMSUNG HAS BEEN ADVISED OF THE POSSIBILITY OF SUCH DAMAGES. Some states do not allow exclusion or limitation of incidental or consequential damages, so the above limitations or exclusions may not apply to you. This warranty gives you specific rights, and you may also have other rights, which vary from state to state.

SAMSUNG does not warrant uninterrupted or error-free operation of the product. No warranty or guarantee given by any other person, firm, or corporation with respect to this product shall be binding on SAMSUNG.

To obtain warranty service, please contact SAMSUNG at:

**Samsung Electronics America, Inc.**  
85 Challenger Road  
Ridgefield Park, NJ 07660  
1-800-SAMSUNG (726-7864) and [www.samsung.com/us/support](http://www.samsung.com/us/support)

## Warranty (CANADA)

**PLEASE DO NOT DISCARD. THIS PAGE REPLACES THE WARRANTY PAGE IN THE USE & CARE GUIDE**

**SAMSUNG ELECTRIC OVEN**

### LIMITED WARRANTY TO ORIGINAL PURCHASER

This SAMSUNG brand product, as supplied and distributed by SAMSUNG ELECTRONICS CANADA, INC. (SAMSUNG) and delivered new, in the original carton to the original consumer purchaser, is warranted by SAMSUNG against manufacturing defects in materials and workmanship for a limited warranty period of:

**ONE (1) YEAR PARTS AND LABOR,  
FIVE (5) YEARS PARTS WARRANTY FOR MAGNETRON**

This limited warranty begins on the original date of purchase, and is valid only on products purchased and used in the CANADA. To receive warranty service, the purchaser must contact SAMSUNG for problem determination and service procedures. Warranty service can only be performed by a SAMSUNG authorized service center. The original dated bill of sale must be presented upon request as proof of purchase to SAMSUNG or SAMSUNG's authorized service center. Samsung will provide in-home service during the warranty period at no charge subject to availability within the contiguous CANADA. In home service is not available in all areas. To receive in home service, the product must be unobstructed and accessible to the service agent. If service is not available Samsung may elect to provide transportation of the product to and from an authorized service center.



---

SAMSUNG will repair or replace this product, at our option and at no charge as stipulated herein, with new or reconditioned parts or products if found to be defective during the limited warranty period specified above. All replaced parts and products become the property of SAMSUNG and must be returned to SAMSUNG. Replacement parts and products assume the remaining original warranty, or ninety (90) days, whichever is longer. This limited warranty covers manufacturing defects in materials and workmanship encountered in normal, noncommercial use of this product and shall not apply to the following: damage which occurs in shipment; delivery and installation; applications and uses for which this product was not intended; altered product or serial numbers; cosmetic damage or exterior finish; accidents, abuse, neglect, fire, water, lightning or other acts of nature; use of products, equipment, systems, utilities, services, parts, supplies, accessories, applications, installations, repairs, external wiring or connectors not supplied or authorized by SAMSUNG which damage this product or result in service problems; incorrect electrical line voltage, fluctuations and surges; customer adjustments and failure to follow operating instructions, maintenance and environmental instructions that are covered and prescribed in the instruction book; product removal and reinstallation; problems caused by pest infestations, and overheating or overcooking by user. This limited warranty shall not cover cases of incorrect electric current, voltage or supply, light bulbs, house fuses, house wiring, cost of a service call for instructions, or fixing installation errors. SAMSUNG does not warrant uninterrupted or error-free operation of the product.

---

EXCEPT AS SET FORTH HEREIN THERE ARE NO WARRANTIES ON THIS PRODUCT EITHER EXPRESS OR IMPLIED AND SAMSUNG DISCLAIMS ALL WARRANTIES INCLUDING, BUT NOT LIMITED TO, ANY IMPLIED WARRANTIES OF MERCHANTABILITY, INFRINGEMENT OR FITNESS FOR A PARTICULAR PURPOSE. NO WARRANTY OR GUARANTY GIVEN BY ANY PERSON, FIRM OR CORPORATION WITH RESPECT TO THIS PRODUCT SHALL BE BINDING ON SAMSUNG. SAMSUNG SHALL NOT BE LIABLE FOR LOSS OF REVENUE OR PROFITS, FAILURE TO REALIZE SAVINGS OR OTHER BENEFITS, OR ANY OTHER SPECIAL, INCIDENTAL OR CONSEQUENTIAL DAMAGES CAUSED BY THE USE, MISUSE OR INABILITY TO USE THIS PRODUCT, REGARDLESS OF THE LEGAL THEORY ON WHICH THE CLAIM IS BASED, AND EVEN IF SAMSUNG HAS BEEN ADVISED OF THE POSSIBILITY OF SUCH DAMAGES. NOR SHALL RECOVERY OF ANY KIND AGAINST SAMSUNG BE GREATER IN AMOUNT THAN THE PURCHASE PRICE OF THE PRODUCT SOLD BY SAMSUNG AND CAUSING THE ALLEGED DAMAGE. WITHOUT LIMITING THE FOREGOING, PURCHASER ASSUMES ALL RISK AND LIABILITY FOR LOSS, DAMAGE OR INJURY TO PURCHASER AND PURCHASER'S PROPERTY AND TO OTHERS AND THEIR PROPERTY ARISING OUT OF THE USE, MISUSE OR INABILITY TO USE THIS PRODUCT. THIS LIMITED WARRANTY SHALL NOT EXTEND TO ANYONE OTHER THAN THE ORIGINAL PURCHASER OF THIS PRODUCT, IS NONTRANSFERABLE AND STATES YOUR EXCLUSIVE REMEDY.

Some states do not allow limitations on how long an implied warranty lasts, or the exclusion or limitation of incidental or consequential damages, so the above limitations or exclusions may not apply to you. This warranty gives you specific legal rights, and you may also have other rights which vary from state to state.

To obtain warranty service, please contact SAMSUNG at:

**Samsung Electronics Canada Inc.**  
2050 Derry Road West, Mississauga, Ontario L5N 0B9 Canada  
1-800-SAMSUNG (726-7864) and [www.samsung.com/ca/support](http://www.samsung.com/ca/support) (English)  
[www.samsung.com/ca\\_fr/support](http://www.samsung.com/ca_fr/support) (French)

# Appendix

---

## Open Source Announcement

---

The software included in this product contains open source software. You may obtain the complete corresponding source code for a period of three years after the last shipment of this product by contacting our support team via <http://opensource.samsung.com>(Please use the "Inquiry" menu.)

It is also possible to obtain the complete corresponding source code in a physical medium such as a CD-ROM; a minimal charge will be required.

The following URL [http://opensource.samsung.com/opensource/COMMON\\_TZ6\\_0/seq/0](http://opensource.samsung.com/opensource/COMMON_TZ6_0/seq/0) leads to the open source license information as related to this product. This offer is valid to anyone in receipt of this information.



**Memo**

---



Scan this with your smartphone

Scan the QR code\* or visit  
[www.samsung.com/spsn](http://www.samsung.com/spsn)  
to view our helpful  
How-to Videos and Live Shows  
\* Requires reader to be installed on your  
smartphone

Please be advised that the Samsung warranty does NOT cover service calls to explain product operation, correct improper installation, or perform normal cleaning or maintenance.

#### QUESTIONS OR COMMENTS?

COUNTRY	CALL	OR VISIT US ONLINE AT
U.S.A Consumer Electronics	1-800-SAMSUNG (726-7864)	<a href="http://www.samsung.com/us/support">www.samsung.com/us/support</a>
CANADA	1-800-SAMSUNG (726-7864)	<a href="http://www.samsung.com/ca/support">www.samsung.com/ca/support</a> (English) <a href="http://www.samsung.com/ca_fr/support">www.samsung.com/ca_fr/support</a> (French)

