

quick setup guide

DVD Recorder & VCR DVD-VR375

- 1 EZ REC MODE
- 2 General Information
- 3 Getting Connected
- 4 Setup
- 5 Basic Operation
- 6 Disc compatibility

1 EZ REC MODE

This function allows you finalize a disc automatically.

1. Press the ▲▼ buttons to select **EZ Record**, then press the **ENTER** button.
2. Press the ▲▼ buttons to select **On**, then press the **ENTER** button. Press the **EXIT** button to exit the menu. You can operate EZ Record by using EZ REC MODE button on the remote control.
3. Insert a disc. If the disc is a new DVD-RW, it is initialized to V mode automatically.
4. Press the **REC** button.
5. EZ Record function will automatically finalize the disc under the following conditions.
 - When you press the OPEN/CLOSE button on your DVD Recorder & VCR after recording on at least 30% of the disc. The tray will open after the disc has been finalized.
 - The above feature is available only when a DVD-RW(V)/-R(V)+R disc is inserted.



2 General Information

Available Discs

- Select a disc based on your intended use.
- Purchase DVD-RAM/±RW/-R discs if you want to edit after recording. (When using a DVD-RW/-R disc, you can edit after recording in VR mode only)
 - Purchase DVD±R discs if you want to record once without editing.

Recordable discs

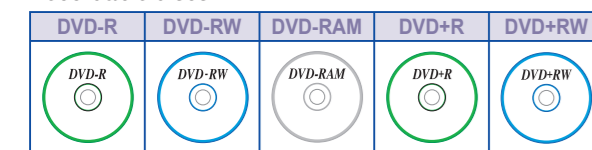

Non recordable discs

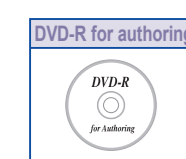

Disc Types that can be played

- DVD-RAM/±RW/±R, DVD-VIDEO, CD-RW/-R, Audio CD (CD-DA), MP3, JPEG discs
- DVD±R/DVD-RW discs which have been recorded on another DVD recorder, can only be played on the DVD-VR375 when finalized.

Cautions when you use discs

- Using poor quality DVD-RAM/±RW/±R discs may cause unexpected problems such as recording failure or loss of recorded / edited data.
- A copy protected disc can not be recorded.

Before Recording

This DVD Recorder & VCR can Record or Playback high quality video/ audio on DVD-RAM/±RW/±R discs or VHS tapes. It takes 12 seconds to initialize and 20 seconds to load after you press the POWER button for the first time.

- With this DVD Recorder & VCR, you can record TV, Video and from external devices connected to the DV (IEEE 1394) jack onto a DVD-RAM/±RW/±R disc.

- There are two different recording methods, Direct Recording and Timer Recording.
- Check that the disc has enough available space for the recording.
- For detailed information about recording, please refer to the Instruction manual.



Recordable disc Specifications

Disc Types	Recording Format	Finalize	Playback on other DVD players
DVD-R	V mode	Finalized	OK
		Not Finalized	Not available (Finalize to play)
DVD-RW	VR Mode	-	Check if other manufacturer's product is supported. (Most players do not support VR-mode)
DVD-RAM	VR mode	Finalized	OK
		Not Finalized	Not available (Finalize to play)
DVD+RW	-	-	OK
DVD+R	-	Finalized	OK
		Not Finalized	Not available (Finalize to play)

- Some DVD Players cannot play writable Discs. Please check the DVD player's specifications.
- Once a recorded DVD±R is finalized, it can be played in standard DVD players.
- DVD-RW/-R discs can be formatted in Video or VR mode.
- CD-RW/-R discs are for playback only.
- DVD-RAM discs are formatted to VR-mode only.
- In VR-mode, it is possible to use functions that have not been finalized such as all disc-deletion, revision, partial edition, and title edition.
- Up to 99 titles can be recorded onto a disc.

- **Finalize**
 - This closes the DVD-RW±R so no additional recording can be done.
 - The DVD-RAM/+RW disc cannot be finalized.
- **Unfinalize**
 - This allows additional recording on a DVD-RW disc originally recorded on the DVD-VR375.
 - A DVD-RW disc that has been recorded by DAO (Disc at Once) on a PC cannot be unfinalized.
 - A DVD-RW disc that has been recorded in Video Mode of a different manufacturer's recorder cannot be unfinalized.
 - A DVD±R disc cannot be unfinalized.

3 Getting Connected (Basic Connections)

Tunerless DVD Recorder & VCR

The DVD-VR375 does not have a TV tuner. Recording TV broadcasts is possible via Connection to Set Top/Cable Box/Satellite and Multi Channel Video Services.

Using HDMI or Audio-Video cable

Use one of these basic connections to get up and running. HDMI offers the best quality picture.

Using Audio-Video/Component cable (Other Connection possibilities)

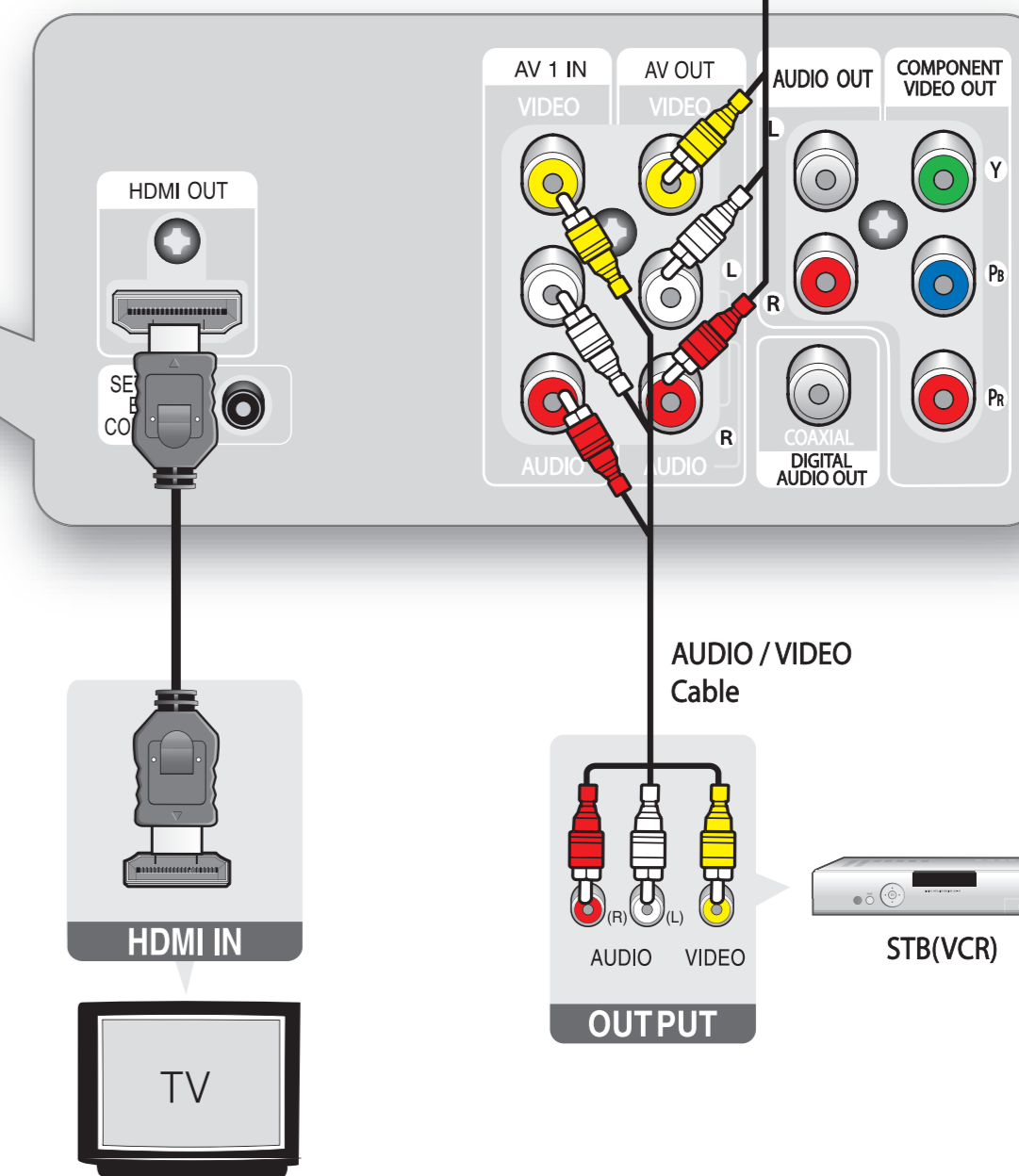
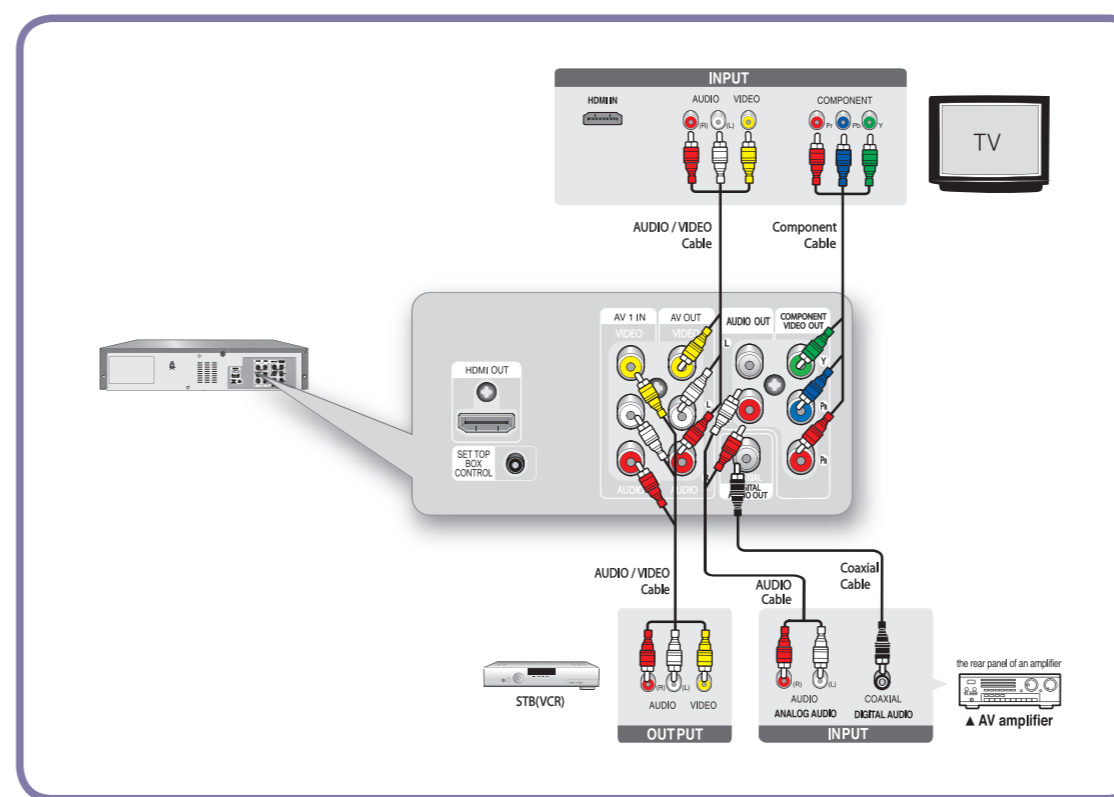

- If your TV has an HDMI input, connect an HDMI cable for the best quality image and sound.

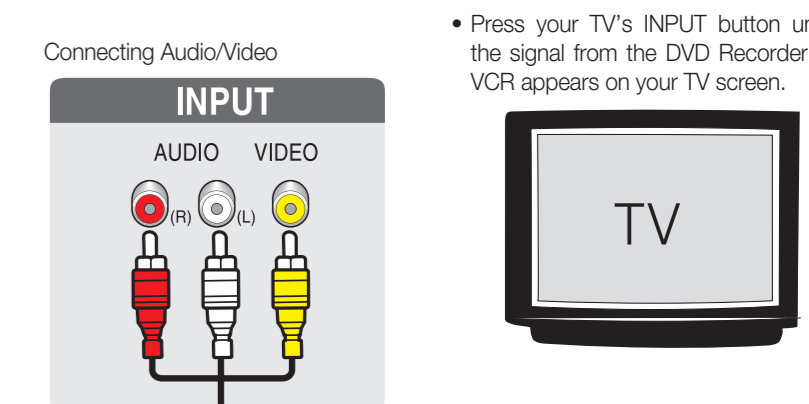

- Press your TV's INPUT button until the signal from the DVD Recorder & VCR appears on your TV screen.

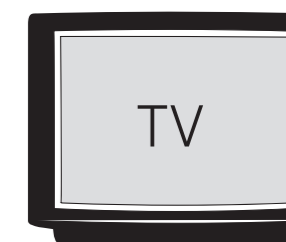

4 Setup

Clock Set

- With the unit in Stop /No Disc mode (no disc inserted in the unit), press the **MENU** button.
- Press the **▲▼** buttons to select **Setup**, then press the **ENTER** button.
- Press the **▲▼** buttons to select **Clock Set**, then press the **ENTER** button.
- Press the **▲▼◀▶** buttons to select the Current Date and Current Time, then press the **ENTER** button.

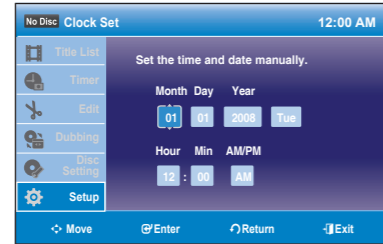

Audio Setup

(Refer to "Audio Setting" on page 32 of the User's manual for more information) Allows you to set up audio options to work with your audio system.

- With the unit in Stop mode/No Disc mode, press the **MENU** button.
- Press the **▲▼** buttons to select **Setup**, then press the **ENTER** button.
- Press the **▲▼** buttons to select **Audio**, then press the **ENTER** button.
- Press the **▲▼** buttons to select the desired audio option, then press the **ENTER** button.
- Press the **▲▼** buttons to select the desired item, then press the **ENTER** button.

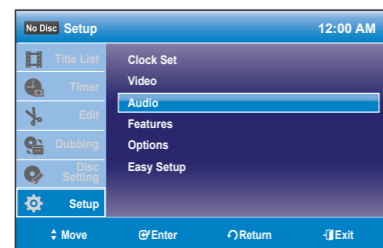

Video Setup

This function allows you to setup the TV screen settings.

- With the unit in Stop mode, press the **MENU** button.
- Press the **▲▼** buttons to select **Setup**, then press the **ENTER** button.
- Press the **▲▼** buttons to select **Video**, then press the **ENTER** button.
- Press the **▲▼** buttons to select the desired video option, then press the **ENTER** button.
- Press the **▲▼** buttons to select the desired item, then press the **ENTER** button.

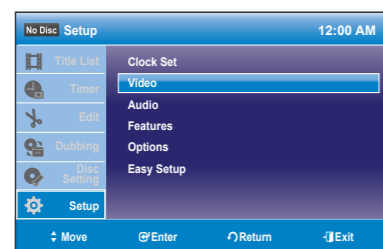

5 Basic Operation

Recording Formats

Since available functions differ depending on the disc type, select a disc that best fits your preference.

When you insert an unused disc, the following message appears.

- DVD-RAM/±RW/+R : Format will be started automatically.
- DVD-R : Initializing the disc is unnecessary.

DVD-RAM/-RW(VR)/-R(VR)

- This mode involves multiple editing functions (such as deletion of the whole title, partial deletion of a title, etc.).
- Various editing options using a created Playlist.

DVD-RW(V)/-R(V)

- Chapters will be created automatically when you finalize recording on DVD-R/DVD-RW discs in Video mode.
- Simple editing (erasing titles/changing title name).

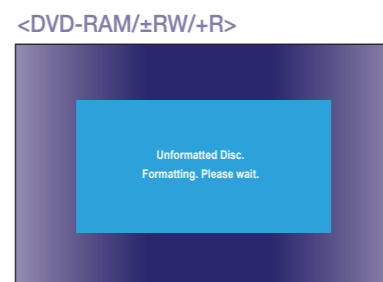

Formatting a Disc

Use these instructions to format a disc.

Disable disc protection before formatting.

- With the unit in Stop mode, press the **MENU** button.
- Press the **▲▼** buttons to select **Disc Setting**, then press the **ENTER** button.
- Press the **▲▼** buttons to select **Disc Format**, then press the **ENTER** button.

DVD+RW

- You will be prompted with the confirmation message 'All of the data will be erased (even protected titles). Do you want to format this disc?'.

DVD-RAM/-RW

- You will be prompted with the confirmation message 'Select the recording format.' (When using a DVD-RAM disc, you can select VR mode only)
- You will be prompted with the confirmation message 'All of the data will be erased (even protected titles). Do you want to format this disc?'.

- You will be prompted with the confirmation message 'Do you want to format disc?'.

- Press the **◀▶** buttons to select **OK**, then press the **ENTER** button. The disc is formatted.

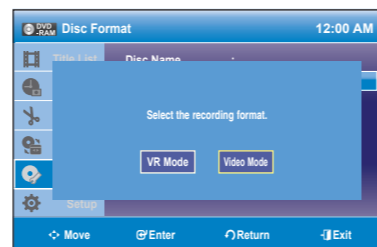
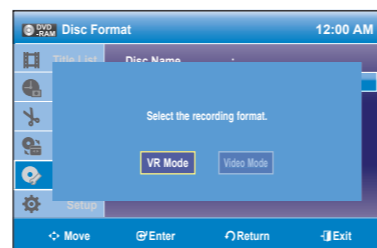

Finalizing a Disc

After you record titles onto a DVD-RW/DVD±R disc with your DVD Recorder & VCR, it needs to be finalized before it can be played back on external devices.

- With the unit in Stop mode, press the **MENU** button.
- Press the **▲▼** buttons to select **Disc Setting**, then press the **ENTER** button.
- Press the **▲▼** buttons to select **Disc Finalize**, then press the **ENTER** button. You will be prompted with the message 'Do you want to finalize this disc?'.
- Press the **◀▶** buttons to select **Finalize**, then press the **ENTER** button. You will be prompted again with the message "Disc will be finalized. Do you want to continue?".
- Press the **◀▶** buttons to select **OK**, then press the **ENTER** button. The disc is finalized.

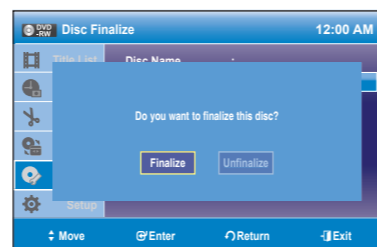

- Once a disc is finalized, you cannot delete titles from the record list.
- Once a DVD±R/DVD-RW (video mode) disc is finalized, it is playable in a standard DVD player.
- Depending on the disc type, the displayed screen may be different.
- Finalizing time may be different depending on the amount of data recorded on the disc.
- Data on the disc will be damaged if the recorder is powered off during finalize process.
- You can Finalize the disc automatically using the EZ REC MODE. (See page 36)

Recording Mode (DVD)

With the unit in Stop mode, select one of eight recording modes by pressing the REC SPEED button repeatedly for the desired recording time and picture quality.

In general, picture quality improves as the recording time decreases. In AUTO mode, the most suitable record mode is adjusted automatically, according to remaining time on the disc and length of the timer recording.

Recording Mode (DVD)	Recording Times	
	DVD-RAM/±RW/±R	
HQ (high quality mode)	Approx. 1 hour	
HSP	Approx. 1 hour 30 minutes	
SP (standard quality mode)	Approx. 2 hours	
LSP	Approx. 2 hours 30 minutes	
ESP	Approx. 3 hours	
LP	Approx. 4 hours	
EP	Approx. 6 hours	
SLP (long duration mode)	Approx. 8 hours	

- The dual layer DVD±Rs have approximately double the capacity of single layer DVD±Rs. (See page 47.)

Recording Mode (VCR)

Recording Mode (VCR)	Recording Times		
	T-120	T-160	T-180
SP (Standard Play)	Approx. 2 hrs	Approx. 2hrs 40 mins	Approx. 3 hrs
EP (Extended Play)	Approx. 6 hrs	Approx. 8 hrs	Approx. 9 hrs

Recording from External Equipment you are Watching

- When using the set top/cable box or satellite receiver control, select the channel. When not using the set top/cable box or satellite receiver control, select the input AV1 or AV2. Select the channel on connected set top/cable box or satellite receiver before timer recording starts.
- Press the **REC SPEED** button repeatedly to select the recording Speed (quality).
- When your DVD Recorder & VCR is in the Stop mode, set the operation mode of your external devices to play mode.
- Press the **REC** button on your DVD Recorder & VCR when the image from which you want to start recording is displayed.
 - To stop recording -
 Press the **STOP** button to stop a recording in progress.

Making a Timer Recording on a Disc

- Press the **OPEN/CLOSE** button, and place a recordable disc on the disc tray (or load a tape into the VCR).
- Press the **OPEN/CLOSE** button to close the disc tray. Wait until "LOAD" disappears from the front panel display.
- With the unit in Stop mode, press the **MENU** button.
- Press the **▲▼** buttons to select **Timer**, then press the **ENTER** button.
- Press the **▲▼** buttons to select **Timer-Standard**, then press the **ENTER** button. You can go to the Timer recording screen directly by pressing the **TIMER REC** button. The Timer Recording screen is displayed.
- Fill in the items using the **▲▼◀▶** buttons.
◀▶ : Moves to the previous/next item,
▲▼ or 0-9 : To set or change items in the Scheduled Record List Menu.

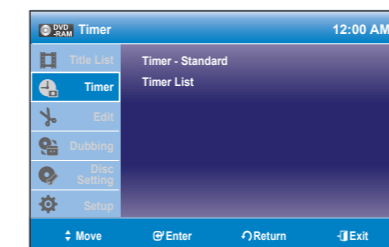

- The icon and Timer Set will appear on the front panel display, indicating a timer recording is set. Recording automatically begins when the set time is reached.
- If AUTO mode is selected, the video quality is adjusted automatically so that scheduled recordings fit onto the free disc space. To record on a tape, please see the owner's manual.

Anynet+(HDMI CEC)

Anynet+ is a function that can be used to operate the recorder using a Samsung TV remote control, by connecting the DVD Recorder & VCR to a SAMSUNG TV using an HDMI Cable. (see page 21) (This is only available with SAMSUNG TVs that support Anynet+.)

- Press the **▲▼** buttons to select **Anynet+(HDMI CEC)**, then press the **ENTER** button. Anynet+(HDMI CEC) items will be displayed.
- Press the **▲▼** buttons to select **On**, then press the **ENTER** button.

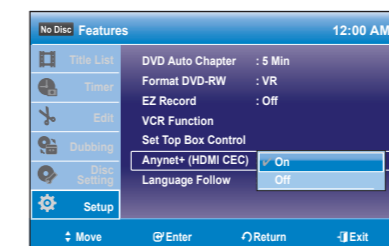

Recording from external equipment connected to the front jacks

You can record from connected equipment, such as a camcorder by using the AV2 IN or DV IN jacks on front of the DVD Recorder & VCR.

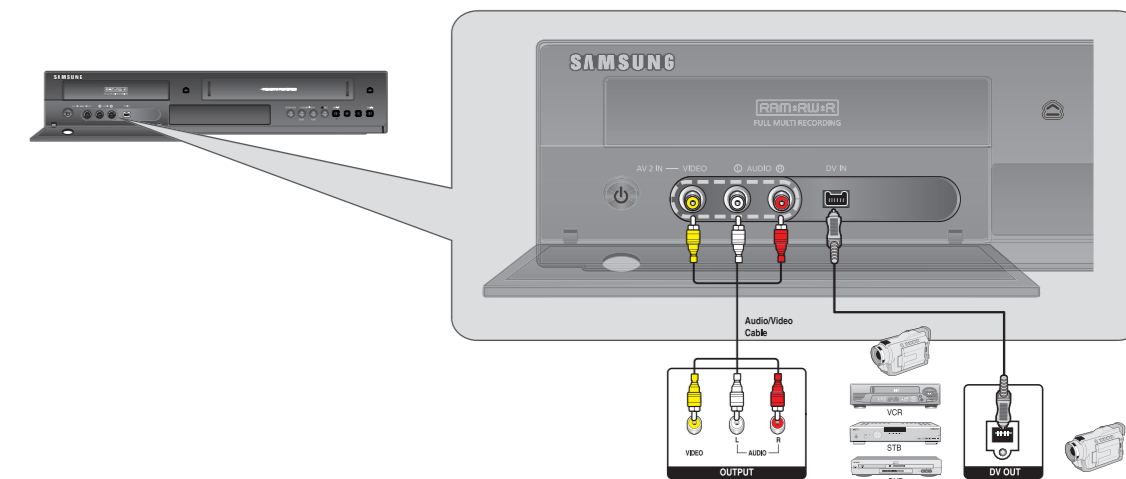

- Connect the DV output jack of your camcorder to the DV input jack on the front of your DVD Recorder & VCR using a DV cable.
- Power on your DVD Recorder & VCR and switch to DV mode by pressing the **INPUT SEL.** button on the remote control.
- Press the **REC SPEED** button repeatedly to select the recording Speed (quality).
- If the input is set to DV, a playback/record menu that enables camcorder control appears on the top of the screen.
- Select the Playback related icons on the upper part of the screen to playback the camcorder and find the starting position to dubbing.
- To start recording, Press the **◀▶** buttons to select **REC** (●) icon in the top side of the screen, then press the **ENTER** button. You can press the **REC** button on the remote control to start recording.
- Press the **STOP** button on your DVD Recorder & VCR when the recording is finished.

- Recordings are made onto disc only through the DV In jack. You cannot record onto videotape through the DV Input jack.

6 Disc compatibility

- Not all brands of discs will be compatible with this unit.
- The latest firmware upgrade to improve recording & playback quality can be downloaded from our web site. (Download Center at www.samsung.com)
- If disc compatibility problems continue, or there is an issue upgrading your recorder, contact the Call Center at 1-800-SAMSUNG.