

# RF23BB8600

SAMSUNG

## Bespoke Counter Depth 4-Door French Door Refrigerator (23 cu. ft.) with Beverage Center™



### Signature Features

#### Customizable Door Colors

Customize the design of your refrigerator with changeable color door panels. Choose from 12 colors and 2 finishes to create a space that fits your style – the options are endless.

#### Beverage Center™

Quick access to refreshingly cool, filtered water two ways. Choose from an internal dispenser or a built-in pitcher that automatically refills, with the option to infuse with a flavor.

#### Dual Ice Maker with Ice Bites

Enjoy your favorite beverage with your choice of ice. Select from cubed ice or Ice Bites that chill your drink faster. Makes up to 5.3 lbs per day, stores up to 7.3 lbs total.

### Bespoke 4-Door Refrigerator Standard Color Models



Stainless Steel - All Panels



White Glass - All Panels



Morning Blue Glass Top Panel with White Glass Middle and Bottom Panels



Custom Panel-Ready



### Design

- Customizable Door Colors
- Modern Design
- Recessed Handle

### Technology

- Beverage Center™
- Wi-Fi Enabled

### Performance

- Dual Ice Maker with Ice Bites
- FlexZone™ Drawer
- Metal Cooling
- 23 cu. ft. Capacity
- Twin Cooling Plus

### Rating



ENERGY STAR® rated:  
621 kWh/yr



ADA Compliant

# RF23BB8600

**SAMSUNG**

## Bespoke Counter Depth 4-Door French Door Refrigerator (23 cu. ft.) with Beverage Center™

### Installation Specifications

1. Measure the height, width and depth of the opening, making sure to include baseboards, molding tile, countertop overhang, etc. Check to be sure there is enough room to open the door (consider walls, islands or other obstacles when measuring).
2. Refer to illustration below to determine dimensions.
3. Allow 2.5" of clearance on hinge side of refrigerator when installing next to a wall where handle may make contact.
4. Allow 1" minimum clearance at rear for proper air circulation and water/electrical connections. Allow a 3/8" minimum clearance at sides and top for ease of installation.
5. Ensure each door and entryway in the home is wide enough for the refrigerator to be moved through easily.

For optimal usage and ability to open refrigerator doors completely, do not install next to a wall.

Please note: The following dimension and cutout information is for planning purposes only. For complete installation details, consult manual packed with product, or download manual online at [samsung.com](http://samsung.com).

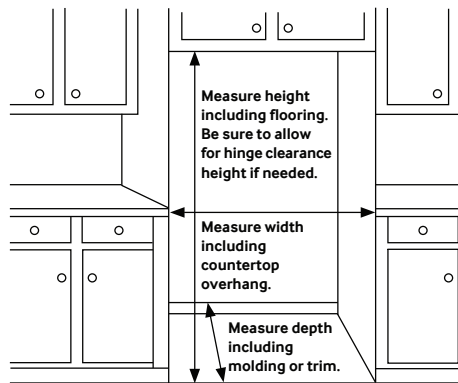

### Dimensions

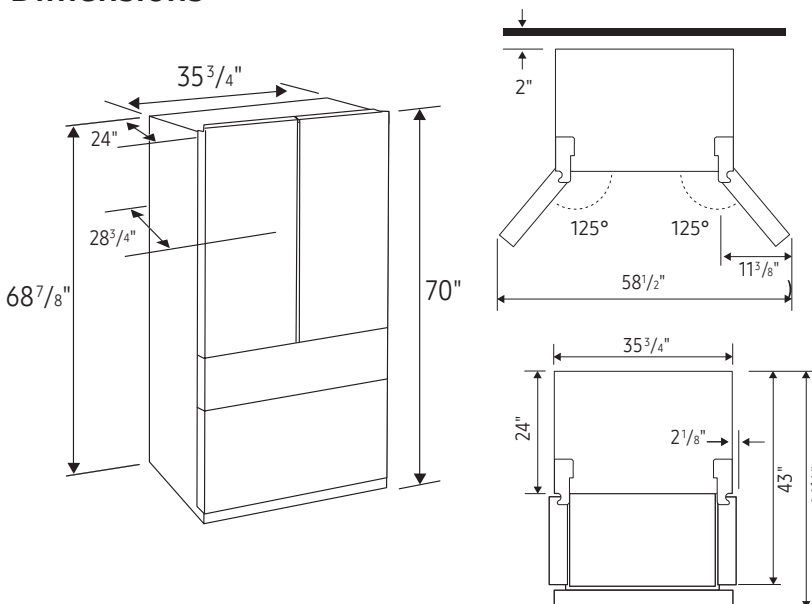

**Total Capacity: 22.8 cu. ft.**

**Refrigerator: 13.5 cu. ft.**

- 4 Tempered Glass Spill-Proof Shelves
- 2 Clear Drawers, Including Crisper+
- 6 Door Bins  
Right: 1 Gallon Bin, 2 Regular Bins  
Left: 3 Regular Bins
- Surface Lighting

**FlexZone™ Drawer: 2.5 cu. ft.**

- 5 Temperature Zones
  - Soft Freeze (23°F)
  - Meat/Fish (30°F)
  - Cold Drinks (34°F)
  - Deli/Snacks (37°F)
  - Wine/Party Dishes (41°F)
- 2 Drawer Dividers
- High Efficiency LED Lighting

**Freezer: 6.8 cu. ft.**

- Dual Ice Maker in Freezer (Cubed Ice AND Ice Bites)
- Ice Bucket with Cover and 1 Scoop
- Produces up to 5.3 lbs ice/day, stores up to 7.3 lbs
- High Efficiency LED Lighting

**Accessories**

Water Filter: HAF-QIN

**Warranty**

- One (1) Year Parts and Labor on Refrigerator
- Two (2) Years Parts and Labor on Ice Maker
- Five (5) Years Parts and Labor on Sealed Refrigeration System Only\*
- Ten (10) Years Parts and Five (5) Years Labor on Digital Inverter Compressor

\*Compressor, evaporator, condenser, drier and connecting tubing.

**Product Dimensions**

Dimensions (WxHxD with hinges and doors):  
35 3/4" x 70" x 28 3/4"

Dimensions (WxHxD without hinges and door):  
35 3/4" x 68 7/8" x 24"

**Shipping Dimensions (WxHxD)**

Dimensions: 38 1/4" x 75 3/4" x 30 5/8"

Color	Model #	UPC Code	Product & Shipping Weight (lbs)	
Stainless Steel - All Panels	RF23BB8600QL	887276624211	330.6	352.7
White Glass - All Panels	RF23BB860012	887276639734	341.7	363.8
Morning Blue Glass Top Panel with White Glass Middle and Bottom Panels	RF23BB86004M	887276639741	341.7	363.8
Custom Panel-Ready	RF23BB8600AP	887276624204	313.1	335.1