

RF29BB8200

SAMSUNG

Bespoke 4-Door French Door Refrigerator (29 cu. ft.) with AutoFill Water Pitcher



Signature Features

Customizable Door Colors

Customize the design of your refrigerator with changeable door panels. Choose from a variety of colors and two finishes to create a space that fits your style.

Extra-large Capacity

With 29 cu. ft. of capacity, this spacious refrigerator is designed for convenience, offering flexibility and organization to store and access all your favorite foods with ease.

Dual Ice Maker with Ice Bites

Enjoy your favorite beverage with your choice of ice. Select from cubed ice or Ice Bites that chill your drink faster. Makes up to 5.4 lbs per day, stores up to 9.9 lbs total.

Bespoke 4-Door Refrigerator Standard Color Models



Stainless Steel - All Panels



White Glass - All Panels



Custom Panel-Ready



Design

- Customizable Door Colors
- Modern Design
- Recessed Handle

Technology

- AutoFill Water Pitcher
- Wi-Fi Enabled

Performance

- Dual Ice Maker with Ice Bites
- FlexZone™ Drawer
- Metal Cooling
- 29 cu. ft. Capacity
- Twin Cooling Plus

Rating



ENERGY STAR® rated:
685 kWh/yr



ADA Compliant

RF29BB8200

SAMSUNG

Bespoke 4-Door French Door Refrigerator (29 cu. ft.) with AutoFill Water Pitcher

Installation Specifications

1. Measure the height, width and depth of the opening, making sure to include baseboards, molding tile, countertop overhang, etc. Check to be sure there is enough room to open the door (consider walls, islands or other obstacles when measuring).
2. Refer to illustration below to determine dimensions.
3. Allow 2.5" of clearance on hinge side of refrigerator when installing next to a wall where handle may make contact.
4. Allow 1" minimum clearance at rear for proper air circulation and water/electrical connections. Allow a 3/8" minimum clearance at sides and top for ease of installation.
5. Ensure each door and entryway in the home is wide enough for the refrigerator to be moved through easily.

For optimal usage and ability to open refrigerator doors completely, do not install next to a wall.

Please note: The following dimension and cutout information is for planning purposes only. For complete installation details, consult manual packed with product, or download manual online at samsung.com.



Dimensions

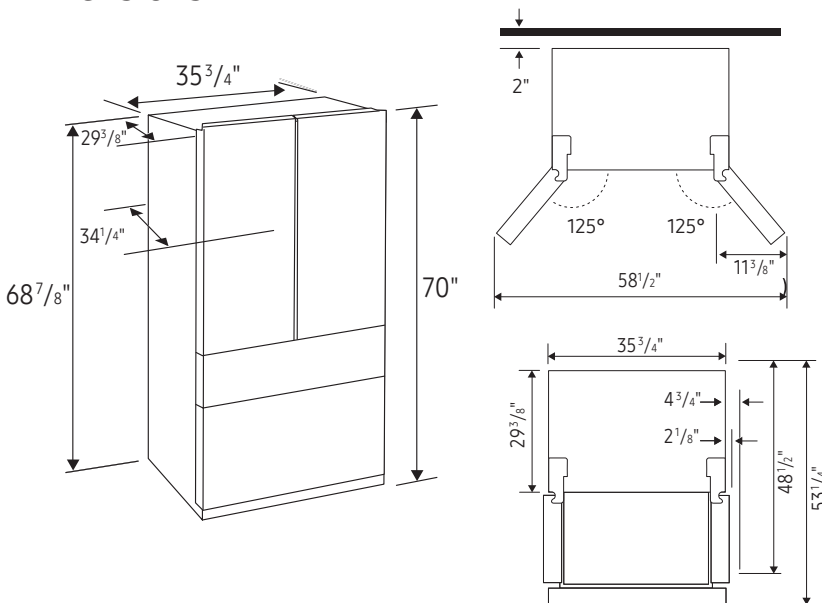

Total Capacity: 28.9 cu. ft.

Refrigerator: 16.8 cu. ft.

- 4 Tempered Glass Spill-Proof Shelves
- 2 Clear Drawers, Including Crisper+
- 6 Door Bins
Right: 1 Gallon Bin, 2 Regular Bins
Left: 1 Gallon Bin, 2 Regular Bins
- Surface Lighting

FlexZone™ Drawer: 3.1 cu. ft.

- 5 Temperature Zones
 - Soft Freeze (23°F)
 - Meat/Fish (30°F)
 - Cold Drinks (34°F)
 - Deli/Snacks (37°F)
 - Wine/Party Dishes (41°F)
- 2 Drawer Dividers
- High Efficiency LED Lighting

Freezer: 9.0 cu. ft.

- Dual Ice Maker in Freezer (Cubed Ice AND Ice Bites)
- Ice Bucket with Cover and 1 Scoop
- Produces up to 5.4 lbs ice/day, stores up to 9.9 lbs
- High Efficiency LED Lighting

Accessories

Water Filter: HAF-QIN

Warranty

One (1) Year Parts and Labor on Refrigerator
Five (5) Years Parts and Labor on Sealed Refrigeration System Only*
Ten (10) Years Parts and Five (5) Years Labor on Digital Inverter Compressor

*Compressor, evaporator, condenser, drier and connecting tubing.

Product Dimensions

Dimensions (WxHxD with hinges and doors):
35 3/4" x 70" x 34 1/4"

Dimensions (WxHxD without hinges and door):
35 3/4" x 68 7/8" x 29 3/8"

Shipping Dimensions (WxHxD)

Dimensions: 38 1/4" x 76 3/4" x 36 1/4"

Color	Model #	UPC Code	Product & Shipping Weight (lbs)	
Stainless Steel - All Panels	RF29BB8200QL	887276624310	332.9	357.1
White Glass - All Panels	RF29BB820012	887276639833	366.0	368.2
Custom Panel-Ready	RF29BB8200AP	887276624303	315.3	339.5