

SAMSUNG

TW-J5500

User manual

Wireless Audio - SoundTower

Imagine the possibilities

Thank you for purchasing this Samsung product.
To receive more complete service, please register your product at
www.samsung.com/register

FEATURES

TV SoundConnect

TV SoundConnect lets you listen to audio from your TV on your Wireless Audio - SoundTower via a Bluetooth connection and lets you control the sound.

Special Sound Modes

You can select different sound modes - MUSIC / VOICE / SPORTS / CINEMA / STANDARD(OFF) - depending on the type of content you want to enjoy.

Multi-function Remote Control

You can use the supplied remote control to control various operations with the simple press of a button.

Bluetooth Function

You can connect a Bluetooth device to the SoundTower and enjoy music with high quality stereo sound, all without wires!

DRC Function

This feature balances the range between the loudest and quietest sounds.

You can use this function to enjoy Dolby Digital sound when watching movies at low volume at night.

LICENSE





Manufactured under license from Dolby Laboratories. Dolby and the double-D symbol are trademarks of Dolby Laboratories.

SAFETY INFORMATION

SAFETY WARNINGS

TO REDUCE THE RISK OF ELECTRIC SHOCK, DO NOT REMOVE THE COVER (OR BACK).

NO USER-SERVICEABLE PARTS ARE INSIDE. REFER SERVICING TO QUALIFIED SERVICE PERSONNEL.

<p style="text-align: center;">CAUTION RISK OF ELECTRIC SHOCK. DO NOT OPEN.</p>		<p>The lightning flash and arrowhead within the triangle indicates that there is dangerous voltage inside the product.</p>
<p>CAUTION: TO REDUCE THE RISK OF ELECTRIC SHOCK, DO NOT REMOVE THE COVER (OR BACK). NO USER SERVICEABLE PARTS INSIDE. REFER SERVICING TO QUALIFIED SERVICE PERSONNEL.</p>		<p>The explanation point within the triangle indicates that there are important instructions accompanying the product.</p>

WARNING

- To reduce the risk of fire or electric shock, do not expose this appliance to rain or moisture.
- To prevent injury, this apparatus must be securely attached to the floor/wall in accordance with the installation instructions.
- This product contains chemicals known to the State of California to cause cancer and reproductive toxicity.

CAUTION

- Do not expose this apparatus to dripping or splashing. Do not put objects filled with liquids, such as vases on the apparatus.
- To turn this apparatus off completely, you must pull the power plug out of the wall socket. Consequently, the power plug must be easily and readily accessible at all times.

SAFETY INFORMATION

This product satisfies FCC regulations when shielded cables and connectors are used to connect the unit to other equipment. To prevent electromagnetic interference with electric appliances, such as radios and televisions, use shielded cables and connectors for connections.

FCC NOTE (for U.S.A.):

This equipment has been tested and found to comply with the limits for a Class B digital device, pursuant to Part 15 of the FCC Rules. These limits are designed to provide reasonable protection against harmful interference in a residential installation.

This equipment generates, uses and can radiate radio frequency energy and, if not installed and used in accordance with the instructions, may cause harmful interference to radio communications. However, there is no guarantee that interference will not occur in a particular installation.

If this equipment does cause harmful interference to radio or television reception, which can be determined by turning the equipment off and on, the user is encouraged to try to correct the interference by one or more of the following measures:

- Reorienting or relocating the receiving antenna.
- Increasing the separation between the equipment and receiver.
- Connecting the equipment to an outlet that is on a different circuit than the radio or TV.
- Consulting the dealer or an experienced radio/TV technician for help.

Caution : FCC regulations state that any unauthorized changes or modifications to this equipment may void the user's authority to operate it.

IMPORTANT SAFETY INSTRUCTIONS

Read these operating instructions carefully before using the unit. Follow all the safety instructions listed below. Keep these operating instructions handy for future reference.

- 1) Read these instructions.
- 2) Keep these Instructions.
- 3) Heed all warnings.
- 4) Follow all instructions.
- 5) Do not use this apparatus near water.
- 6) Clean only with dry cloth.
- 7) Do not block any ventilation openings. Install in accordance with the manufacturer's instructions.

- 8) Do not install near any heat sources such as radiators, heat registers, stoves, or other apparatus (including amplifiers) that produce heat.
- 9) Do not defeat the safety purpose of the polarized or grounding-type plug. A polarized plug has two blades with one wider than the other. A grounding type plug has two blades and a third grounding prong. The wide blade or the third prong are provided for your safety. If the provided plug does not fit into your outlet, consult an electrician for replacement of the obsolete outlet.
- 10) Protect the power cord from being walked on or pinched particularly at plugs, convenience receptacles, and the point where they exit from the apparatus.
- 11) Only use attachments/accessories specified by the manufacturer.
- 12) Use only with the cart, stand, tripod, bracket, or table specified by the manufacturer, or sold with the apparatus. When a cart is used, use caution when moving the cart/apparatus combination to avoid injury from tip-over.
- 13) Unplug this apparatus during lightning storms or when unused for long periods of time.
- 14) Refer all servicing to qualified service personnel. Servicing is required when the apparatus has been damaged in any way, such as power-supply cord or plug is damaged, liquid has been spilled or objects have fallen into the apparatus, the apparatus has been exposed to rain or moisture, does not operate normally, or has been dropped.



- Figures and illustrations in this User Manual are provided for reference only and may differ from actual product appearance.

PRECAUTIONS

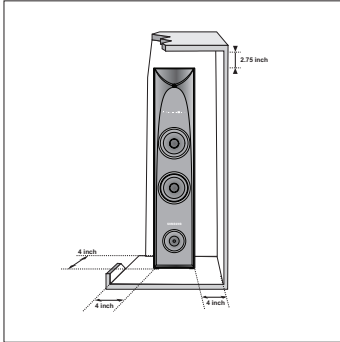

Ensure that the AC power supply in your house complies with the power requirements listed on the identification sticker located on the back of your product. Install your product horizontally, on a suitable base (furniture), with enough space around it for ventilation (2.75~4 inches / 7~10cm). Make sure the ventilation slots are not covered. Do not place the unit on amplifiers or other equipment which may become hot. This unit is designed for continuous use. To fully turn off the unit, disconnect the AC plug from the wall outlet. Unplug the unit if you intend to leave it unused for a long period of time.

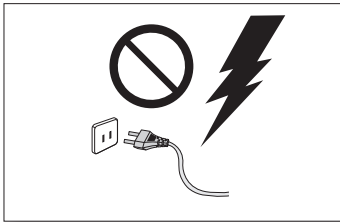

During thunderstorms, disconnect the AC plug from the wall outlet. Voltage peaks due to lightning could damage the unit.

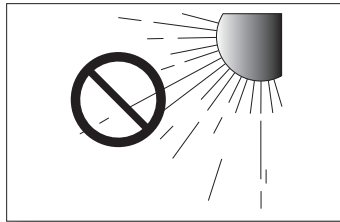

Do not expose the unit to direct sunlight or other heat sources. This could lead to overheating and cause the unit to malfunction.

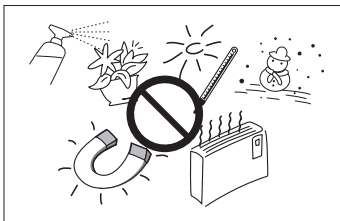

Protect the product from moisture (i.e. vases), and excess heat (e.g. a fireplace) or equipment creating strong magnetic or electric fields. Unplug the power cable from the AC wall socket if the unit malfunctions. Your product is not intended for industrial use. It is for personal use only. Condensation may occur if your product has been stored in cold temperatures. If transporting the unit during the winter, wait approximately 2 hours until the unit has reached room temperature before using.

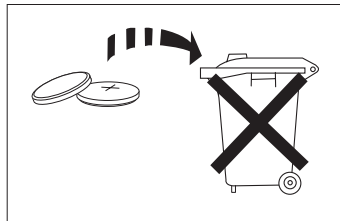

The batteries used with this product contain chemicals that are harmful to the environment. Do not dispose of batteries in the general household trash.

Do not dispose of batteries in a fire.

Do not short circuit, disassemble, or overheat the batteries.

There is a danger of explosion if battery is replaced incorrectly. Replace only with the same or equivalent type.



WARNING: DO NOT INGEST BATTERY. CHEMICAL BURN HAZARD. The remote control supplied with this product contains a coin/button cell battery. If the coin/button cell battery is swallowed, it can cause severe internal burns in just 2 hours and can lead to death. Keep new and used batteries away from children. If the battery compartment does not close securely, stop using the remote and make sure to keep it away from children. If you think the battery might have been swallowed or placed inside any part of the body, seek immediate medical attention.

CONTENTS

2 FEATURES

2 SAFETY INFORMATION

- 2 Safety warnings
- 3 Safety Information
- 3 Important Safety Instructions
- 4 Precautions

6 GETTING STARTED

- 6 Before reading the user's manual
- 6 What's included

7 DESCRIPTIONS

- 7 Front/side panel
- 8 Rear panel

9 REMOTE CONTROL

- 9 Remote control buttons and functions

10 INSTALLATION

- 10 Product installation

11 CONNECTIONS

- 11 Connecting the external components

12 FUNCTIONS

- 12 Input mode
- 13 Bluetooth
- 15 TV SoundConnect
- 16 USB
- 17 Listening to radio
- 18 The Recording function
- 18 Software upgrade

19 TROUBLESHOOTING

20 APPENDIX

- 20 Specifications

CALIFORNIA USA ONLY

This perchlorate warning applies only to primary CR (Manganese Dioxide) Lithium coin cells in the product sold or distributed ONLY in California USA



" Perchlorate Material - special handling may apply,
See www.dtsc.ca.gov/hazardouswaste/perchlorate. "

GETTING STARTED

BEFORE READING THE USER'S MANUAL

Note the following terms before reading the user manual.

► Icons used in this manual

Icon	Term	Definition
	Caution	Indicates a situation where a function does not operate or settings may be canceled.
	Note	Indicates tips or instructions on the page that help you operate a function.

► Safety Instructions and Troubleshooting

- 1) Be sure to familiarize yourself with the Safety Instructions before using this product. (See page 2~3)
- 2) If a problem occurs, check Troubleshooting. (See page 19)

► Copyright

©2015 Samsung Electronics Co.,Ltd.

All rights reserved; no part of this user's manual may be reproduced or copied without the prior written permission of Samsung Electronics Co.,Ltd.

WHAT'S INCLUDED

Check for the supplied accessories shown below.

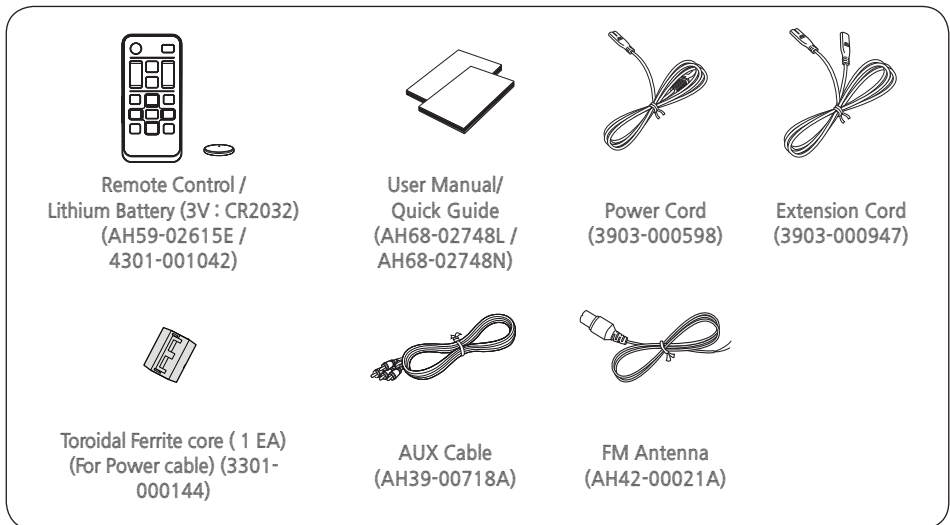

- The appearance of the accessories may differ slightly from the illustrations above.

DESCRIPTIONS

FRONT/SIDE PANEL

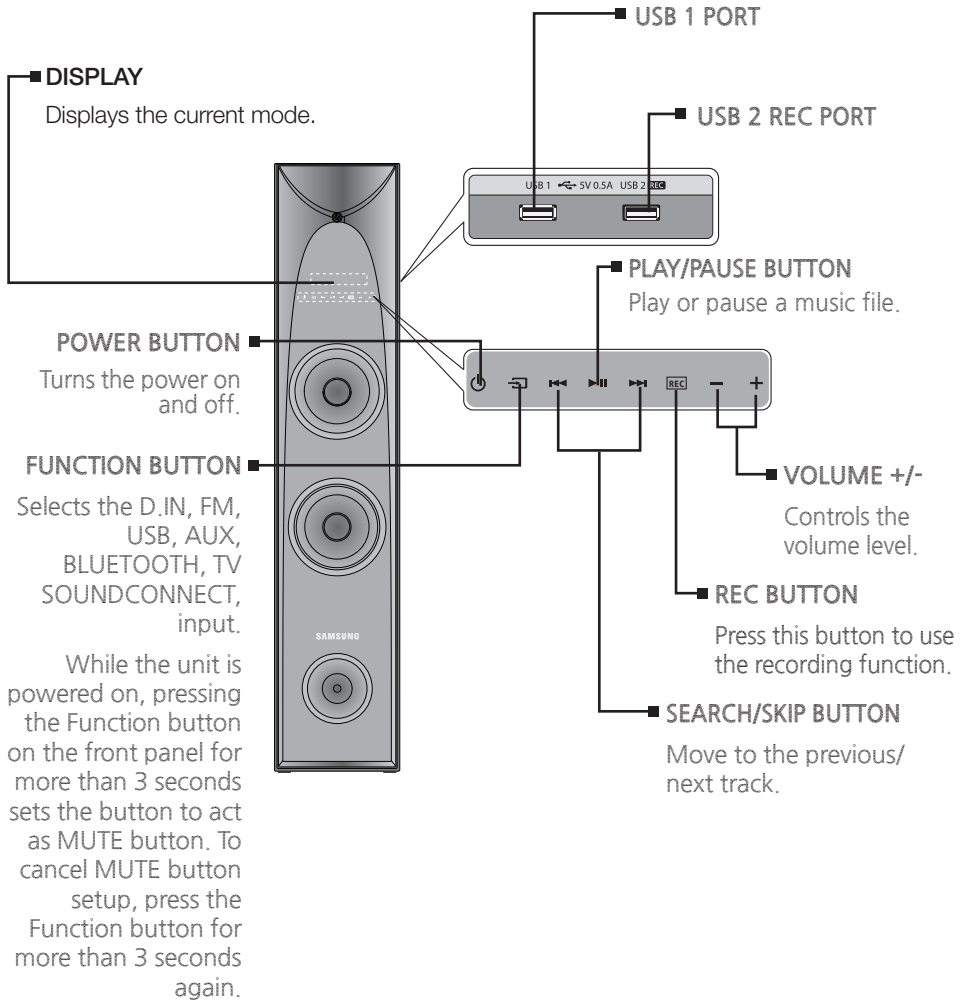

- After you turn on this unit, do not move it or touch its back.
- If you want to hear TV sound from the product only, you must turn off the TV's speakers in the Audio Setup menu of your TV. Refer to the owner's manual supplied with your TV.

DESCRIPTIONS

REAR PANEL

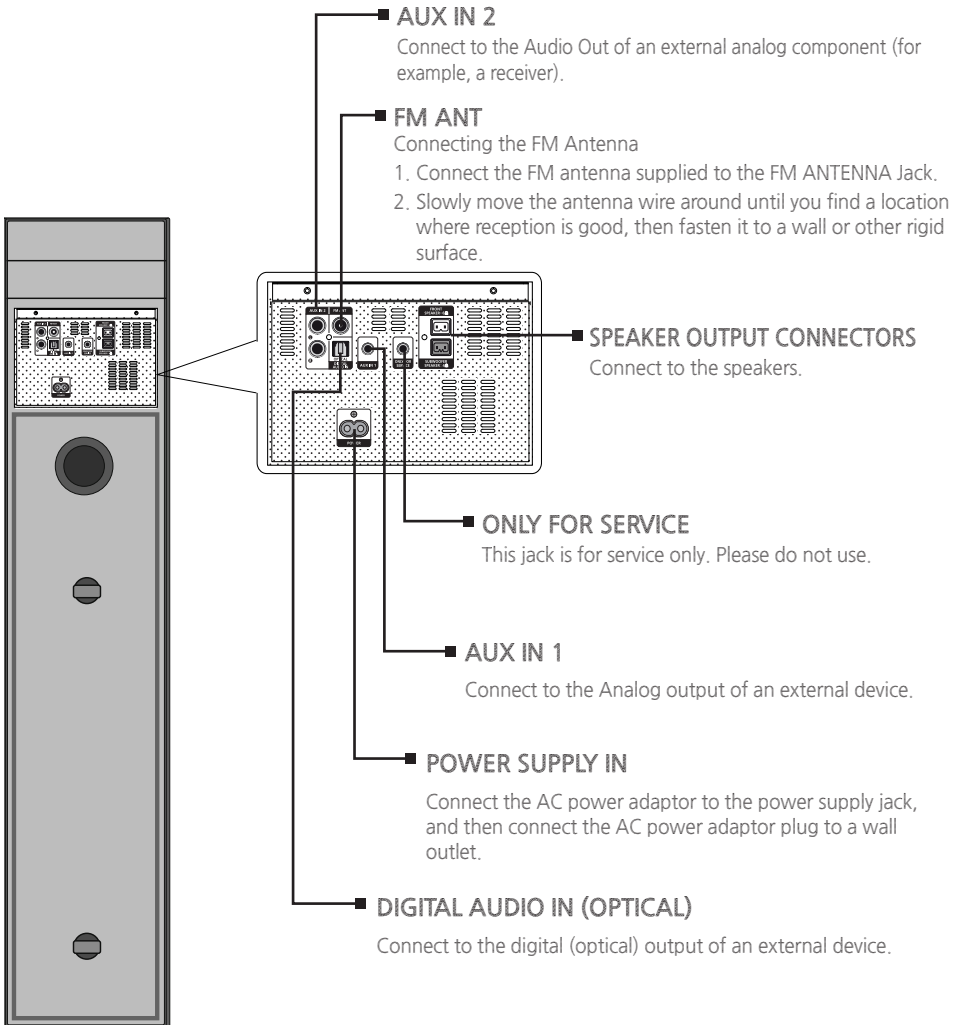

- Do not connect this unit or other components to an AC outlet until all connections between components are complete.
- For safety information including product identification and supply ratings, please refer to the main label on the bottom of the device.

REMOTE CONTROL

REMOTE CONTROL BUTTONS AND FUNCTIONS

POWER
Turns the product on and off.

VOLUME
Adjusts the volume level of the unit.

USB REC
Press to record the selected file.

SOUND EFFECT
Press this button to select one of the following sound modes: **MUSIC, VOICE, SPORTS, CINEMA, STANDARD**. Select the **STANDARD** mode if you want to enjoy the original sound. We recommend that you select a Sound Effect mode based on the source material and your personal taste.

Press and hold this button for 5 seconds to select ON-DRC or OFF-DRC.

Bluetooth POWER
Press this button to select ON-BLUETOOTH POWER or OFF-BLUETOOTH POWER. Press and hold this button to select ON-POWER LINK or OFF-POWER LINK.

POWER
POWER

SOURCE
Press to select a mode you want.

MUTE
Cut off the sound temporarily.

SYNC
Used to help sync video to audio when connected to a digital TV.

STOP/TUNING MODE BUTTON
Stop playing a music file. Press to select the "MANUAL" or "PRESET" radio tuning mode.

CONTROL BUTTON
Play or pause a music file, or search forwards or backwards for a music file. Search for active FM stations.

REPEAT/MO/ST BUTTON
Select Repeat track, dir, All or Random mode. Select MONO or STEREO for radio broadcasts.

ALBUM
Search for an album.

► Installing the Batteries in the Remote Control

1. Use a suitable coin to turn the remote control's battery cover counterclockwise to remove it as shown in the figure above.
2. Insert a 3V lithium battery. Keep the positive (+) pole facing up when inserting the battery. Put the battery cover on and align the ● marks side by side as shown in the figure above.
3. To close the battery compartment, use a suitable coin to turn the remote control's battery cover clockwise as shown in the figure above.



- Operate the TV using the TV's remote control.

INSTALLATION

PRODUCT INSTALLATION

Position of the product

Place the speakers on the floor on either side of your TV. See the illustration below.

Selecting the Listening Position

- The listening position should be located about 2.5 to 3 times the size of the TV's screen away from the TV.
 Example : For 32" TVs: 6.5~7.875 ft (2~2.4m)
 For 55" TVs: 11.5~13 ft (3.5~4m)
- Place the speakers in front of your listening position, facing inwards (at about 45°) toward you. Place the speakers so that their tweeters are at the same height as your ear.

► How to install the product

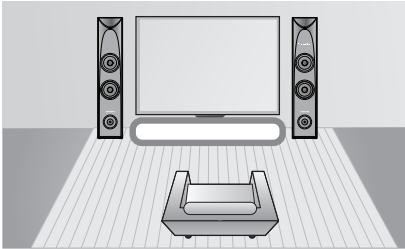

- Do not let children play with or near the speakers. They could get hurt if the speaker falls.
- When connecting the speaker wires to the product, make sure to match the color of the speaker wires to the jacks on the back of the speakers.
- If you place a speaker near your TV set, screen color may be distorted because of the magnetic field generated by the speaker. If this occurs, move the speaker away from your TV set.

► Attaching the toroidal ferrite core to the power cable

If you attach a Toroidal ferrite core to the power cable, it will help to prevent RF interference from radio signals.

1. Pull the fixing tab of the Toroidal ferrite core to open it.
2. Attach the Toroidal ferrite core to the power cable as shown and press it until it clicks.

Attaching the toroidal ferrite core to the power cable

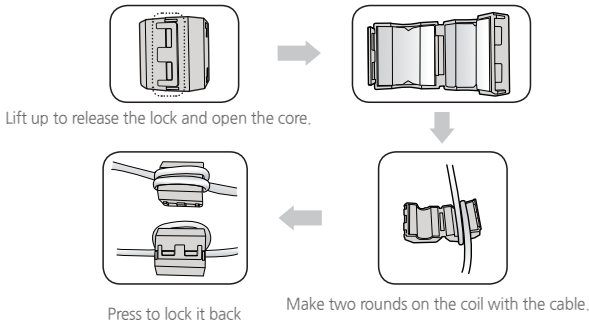

CONNECTING THE EXTERNAL COMPONENTS

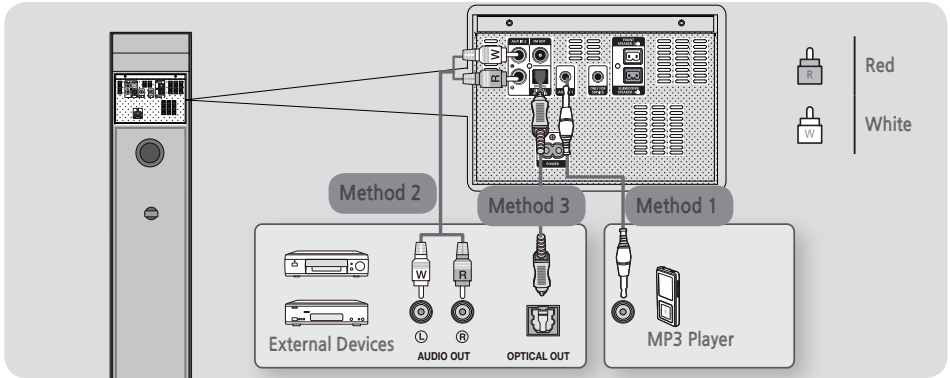

Connecting to External Devices

To select the correct mode for an external device after you have connected the device, press the button. Each time you press the button, the mode changes in this order :

D. IN → FM → USB 1 → USB 2 → AUX 1 → AUX 2 → BLUETOOTH → TV SOUNDCONNECT

Three methods of connecting external devices to your product are explained below.

Method 1 AUX IN 1 : Connecting an External Component/MP3 player

Using an audio cable (not supplied), connect the AUX IN 1 jack on the product to the AUDIO Out jack on the external component/MP3 player. ⇒ Select the **AUX 1** mode.

Method 2 AUX IN 2 : Connecting an External Analog Component

Using an RCA audio cable (supplied), connect the AUX IN 2 jack on the product to the AUDIO Out jack on the external analog component. ⇒ Select the **AUX 2** mode.

- Be sure to match the colors on the cable plugs to the colors on the input and output jacks.

Method 3 OPTICAL : Connecting an External Digital Audio Component

Connect the DIGITAL OPTICAL AUDIO IN jack on the main unit to the OPTICAL OUT of the TV or Source Device. ⇒ Select the **D. IN** mode.

► Using the POWER LINK function

If you connect the main unit to a TV with a digital optical cable, set the Power Link function ON to have the SoundTower turn on automatically when you turn the TV on.

Press and hold the **Bluetooth POWER** button on the SoundTower remote to turn the POWER LINK function on and off.

The Power Link function turns on and off each time you press and hold the **Bluetooth POWER** button.

POWER LINK	Display
ON	ON-POWER LINK
OFF	OFF-POWER LINK

► Using the AUDIO SYNC function

Video may appear out of synch with the audio if the SoundTower is connected to a digital TV. If this occurs, adjust the audio delay time to match the video.

Press the SYNC + / - button on the remote control of this unit.

- You can use the + , - buttons to set the audio delay time between 0 ms and 300 ms.









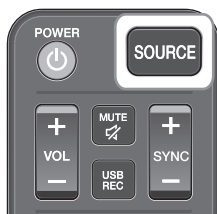
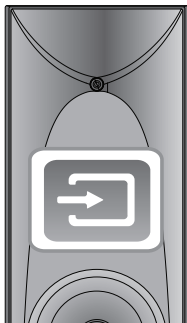

- In USB mode, TV mode, FM mode, or BT mode, the Audio Sync function may not work.
- In D.IN mode, some formats are not supported and will produce no audio.
- Do not connect the power cord of this product or your TV to the wall outlet until all connections between components are complete.
- Before moving or installing this product, be sure to turn off the power and disconnect the power cord.

FUNCTIONS

INPUT MODE

Press the **SOURCE** button on the remote control or the (↪) button on the product's front panel to select the mode you want.



Input mode	Display
Optical Digital input	 D.IN
FM mode	 FM
USB 1 input	 USB 1
USB 2 input	 USB 2
AUX IN 1 input	 AUX 1
AUX IN 2 input	 AUX 2
BLUETOOTH mode	 BLUETOOTH
TV mode	 TV SOUNDCONNECT

The unit turns off automatically in the following situations.

- D.IN/USB 1/USB 2/BLUETOOTH /TV SOUNDCONNECT
 - If no buttons on the unit or remote are pushed and if there is no audio signal for more than 25 minutes.
- AUX Mode
 - When the unit is in AUX mode, if no buttons on the unit or remote are pushed for more than 8 hours, the power will automatically turn off.
 - To turn this auto shut off function ON or OFF, press and hold the ENTER button for 5 seconds in AUX mode, ON / OFF - AUTO POWER DOWN appears on the display.





BLUETOOTH

You can use a Bluetooth device to enjoy music with high quality stereo sound, all without wires!

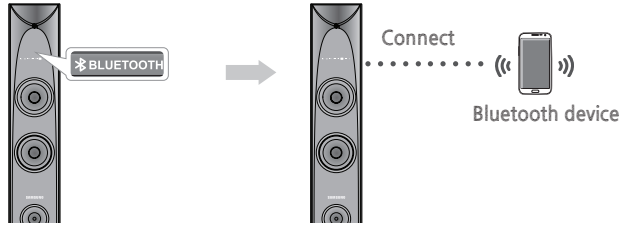
► To connect the product to a Bluetooth device

To pair, the Bluetooth device must support the Bluetooth compliant stereo headset function.



1. Press the **SOURCE** button on the remote control or press the () button on the product's front panel to display the  **BLUETOOTH** message.
 2. Select the Bluetooth menu on the Bluetooth device you want to connect. (Refer to the Bluetooth device's user manual.)
 3. Select the Stereo headset menu on the Bluetooth device.
 - You will see a list of scanned devices.
 4. Select "**[Samsung]SoundTower**" from the list.
 - When the product is connected to the Bluetooth device, it will display "**Device name**" → " **BT**" on the front display.
 - The device name can only be displayed in English. An underline "_" will be displayed if the name is not in English.
 - If the Bluetooth device has failed to pair with the product, delete the previous "**[Samsung]SoundTower**" found by the Bluetooth device and have it search for the product again.
 5. Play music on the connected device.
 - You can listen to the music playing on the connected Bluetooth device over the Wireless Audio - SoundTower.
 - In BLUETOOTH mode, the Play/Pause/Next/Prev functions are not available. However, these functions are available in Bluetooth devices supporting AVRCP.
 - The Album Skip Forward/Backward function is not supported in Bluetooth mode.
- 
 - If asked for PIN code when connecting a Bluetooth device, enter <0000>.
 - Only one Bluetooth device can be paired at a time.
 - The Bluetooth connection will be terminated when you turn the product off.
 - Once you have turned off the product and pairing is terminated, it will not be restored automatically. To reconnect, you must pair the device again.
 - If the product is in FM/D.IN/USB/AUX mode, it will change automatically to Bluetooth mode once it has paired.
 - The product may not perform Bluetooth search or connection correctly under the following circumstances:
 - If there is a strong electrical field around the product.
 - If several Bluetooth devices are simultaneously paired with the product.
 - If the Bluetooth device is turned off, not in place, or malfunctions.
 - Note that such devices as microwave ovens, wireless LAN adaptors, fluorescent lights, and gas stoves use the same frequency range as the Bluetooth device, which can cause electric interference.
 - The product supports SBC data (44.1kHz, 48kHz).
 - Connect only to a Bluetooth device that supports the A2DP (AV) function.
 - You cannot connect the product to a Bluetooth device that supports only the HF (Hands Free) function.

► The Bluetooth POWER Function

When the Bluetooth Power function is on and the product is turned off, if a previously paired Bluetooth device tries to pair with the product, the product turns on automatically.

1. Press the **Bluetooth POWER** button on the remote control while the product is on.
2. **ON-BLUETOOTH POWER** appears on the SoundTower's display.



- Available only if the product is listed among the Bluetooth device's paired devices. (The Bluetooth device and the product must have been previously paired at least once.)
- The product will appear in the Bluetooth device's searched devices list only when the product is displaying [READY].
- In the TV SoundConnect mode, the product cannot be paired to another Bluetooth device.

► To disconnect the Bluetooth device from the product

You can disconnect the Bluetooth device from the product. For instructions, see the Bluetooth device's user manual.

- The product will be disconnected.
- When the product is disconnected from the Bluetooth device, the product will display **DISCONNECTED** on the front display.

► To disconnect the product from the Bluetooth device

Press the **SOURCE** button on the remote control or press the (↔) button on the product's front panel to switch from **BLUETOOTH** to another mode or turn off the product.

- The connected Bluetooth device will wait a certain amount of time for a response from the product before terminating the connection. (Disconnection time may differ, depending on the Bluetooth device)



- In Bluetooth connection mode, the Bluetooth connection will be lost if the distance between the product and the Bluetooth device exceeds 16.25 ft. (5m).

More About Bluetooth

Bluetooth is a technology that enables Bluetooth-compliant devices to interconnect easily with each other using a short wireless connection.

- A Bluetooth device may cause noise or malfunction, depending on usage, when:
 - A part of your body is in contact with the receiving/transmitting system of the Bluetooth device or the product.
 - It is subject to electrical variation from obstructions caused by a wall, corner, or office partition.
 - It is exposed to electrical interference from same frequency-band devices including medical equipment, microwave ovens, and wireless LANs.
- Pair the product with the Bluetooth device while they are close together.
- The further the distance between the product and Bluetooth device, the worse the quality is. If the distance exceeds the Bluetooth operational range, the connection is lost.
- In poor reception-sensitivity areas, the Bluetooth connection may not work properly.
- The Bluetooth connection only works when it is close to the unit. The connection will be automatically cut off if the Bluetooth device is out of range. Even within range, the sound quality may be degraded by obstacles such as walls or doors.
- This wireless device may cause electric interference during its operation.

TV SOUNDCONNECT

You can enjoy TV sound through your product when it is connected to a Samsung TV that supports the TV SoundConnect function.

► Connecting a TV to the product



- Turn on the TV and product.
 - Set the "Add New Device" menu selection of the TV to "On".
- Press the **SOURCE** button on the remote control or press the () button on the product's front panel to select the **TV SOUNDCONNECT** mode.
- On the TV, a message asking whether to enable the TV SoundConnect function appears. "[Samsung] SoundTower" is displayed on the TV screen.
- Select **<Yes>** using the TV remote to finish connecting the TV and product.



- Switching the product's mode from TV to another mode automatically terminates TV SoundConnect.
- To connect the product to another TV, the existing connection must be terminated. To terminate the existing connection, press and hold the **ENTER** () button for 5 seconds. To connect to the other TV, follow Steps 1 through 4 above.



- The TV SoundConnect (SoundShare) function is supported by some Samsung TVs released from 2012 on. Check whether your TV supports the TV SoundConnect (Soundshare) function before you begin. (For further information, refer to the TV's user manual.)
- If your Samsung TV was released before 2014, check the SoundShare setting menu.
- If the distance between the TV and product exceeds 16.25 ft. (5m), the connection may not be stable or the audio may stutter. If this occurs, relocate the TV or product so that they are within operational range, and then re-establish the TV SoundConnect connection.



- TV SoundConnect Operational Range
 - Recommended pairing range: within 19.75 inches (50cm).
 - Recommended operational range: within 16.25 ft. (5m).
- Play/Pause, Next, Prev buttons are not operable in TV SoundConnect mode.

► Using the Bluetooth POWER function with TV SoundConnect.

The Bluetooth POWER function is available after you have successfully connected the product to a Bluetooth compatible TV using TV SoundConnect. When the Bluetooth POWER function is ON, turning the connected TV on or off will turn the product's power on and off as well.

- Connect the TV with your product using the TV SoundConnect function.
- Press the **Bluetooth POWER** button on the remote control. "**ON-BLUETOOTH POWER**" appears on the product's display.
 - ON-BLUETOOTH POWER** : The product turns on and off when you turn the TV on or off.
 - OFF-BLUETOOTH POWER** : The product only turns off when you turn the TV off.





- This function is supported only by some Samsung TVs released from 2013 on.

USB

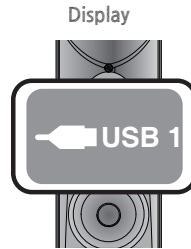
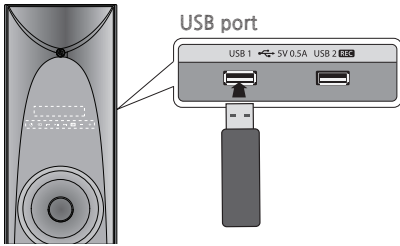
Connect an external storage device such as a USB flash memory or external HDD (Hard Disk Drive) to the product. You can play files in MP3/WMA format.



▶ Connecting the USB Device

1. Connect the USB device to the **USB 1 port** or the **USB 2 port** on the side of the product.
2. Press the **SOURCE** button on the remote control or the () button on the product's front panel repeatedly until  **USB 1** or  **USB 2** appears.
 - The product connection to the USB device is complete.
 - The first track of the first directory plays automatically,

▶ Before you connect a USB device

Be aware of the following:

- Some USB devices may not work properly with this product.
- This product only supports external HDD's that are formatted in the FAT file system.
- USB 2.0 HDDs should be connected to a separate power source. Otherwise, the USB 2.0 HDDs will not work.
- If multiple USB external storage devices are connected together, only the MP3 files in the first HDD will be played.
- Files with DRM are not supported. Digital Right Management (DRM) restricts unauthorized access to a DRM file so that the file is protected from piracy.
- Even if a file has an .mp3 extension, the file cannot be played if it is formatted in MPEG layer 1 or 2.
- Do not use an unrecognized USB hub.
- Only the first 15 characters of an audio file name are shown on the product's display.
- Only removable HDDs with less than 160GB are supported. Depending on the device, a 160GB- or more removable HDD may not be supported.

- It can take several minutes for the product to recognize the files on some USB devices.
- Some USB devices (USB HDDs, in particular) may pause when moving from track to track.
- With USB storage devices supporting USB VER1.1 only, the product may access files slowly or may not recognize the file properties.
- The maximum electrical current provided by each USB port to connected USB devices is 0.5 A (based on DC 5 V).
- If there is no USB connection or STOP mode lasts for more than 25 minutes, the product will automatically turn off.
- Some USB devices, digital cameras, USB card readers, iPods, iPhones, and Smart Phones may not be supported.
- File Format Type Compatibility list:

File Extension	Audio Codec	Sampling Rate	Bit Rate
*.mp3	MPEG 1 Layer3	16KHz ~ 48KHz	80Kbps ~ 320Kbps
	MPEG 2 Layer3	16KHz ~ 48KHz	80Kbps ~ 320Kbps
	MPEG 2.5 Layer3	16KHz ~ 48KHz	80Kbps ~ 320Kbps
*.wma	Wave_Format_MSAudio1	16KHz ~ 48KHz	56Kbps ~ 128Kbps
	Wave_Format_MSAudio2	16KHz ~ 48KHz	56Kbps ~ 128Kbps

- Does not support WMA Professional codec.
- The above table shows supported sampling rates and bit rates. Files recorded in formats the product does not support will not play.

▶ To Select a Track from a USB Device

You can select a track to play while another track is playing.

1. If you want to move to the previous/next track, press the **TUNING** **◀◀**, **▶▶** buttons briefly.
 - The unit moves to the previous/next track within the directory.
 - If you press the **TUNING** **◀◀**, **▶▶** buttons more times than the number of files in the directory, the unit moves to the next directory.

▶ To Move to the Next/Previous Folder

1. Press the **ALBUM** **▲** or **▼** button on the remote control to move to the previous/next folder.
2. When done, you will see the previous/next folder name. The track will start playing.
 - When audio files are stored in the root directory rather than in a folder, press the **ALBUM** **▲** or **▼** button to go to the first **TRACK**.

▶ To Repeat

1. Press the **REPEAT** button on the remote control. Each time you press the **REPEAT** button, the repeat mode will change as follows:
OFF → TRACK → DIR → ALL → RANDOM
2. When you want to stop the Repeat function, press the **REPEAT** button until "OFF" is displayed.
 - OFF: Cancels Repeat Playback.
 - TRACK: Repeatedly plays the selected track.
 - DIR: Repeatedly plays all tracks in the selected folder.
 - ALL: Repeatedly plays all tracks.
 - RANDOM: Plays tracks in random order.

▶ To stop playing

1. Press the **STOP** (■) button to stop playing.

▶ To remove the USB device

1. Press the **STOP** (■) button twice while the USB is playing or press the **STOP** (■) button once when play has stopped.
2. When the **REMOVE** message appears on the display, remove the USB device.

LISTENING TO RADIO

You can store up to 15 FM stations.

1. Press the **SOURCE** button on the remote control or the (📻) button on the product's front panel repeatedly until "📻 FM" appears.
2. Press the **TUNING MODE** button one or more times until **MANUAL** appears in the display.
3. Select the station to be stored by:
 - Pressing the **TUNING** **◀◀** or **▶▶** button on the remote control repeatedly to search for a station one station at a time.
 - Pressing and holding the **TUNING** **◀◀** or **▶▶** button on the remote control to automatically search for active broadcasting stations.
4. Press the **MO/ST** button to switch between stereo and mono.
 - In a poor reception area, select **MONO** for a clear, interference-free broadcast.
 - This applies only when listening to an FM station.
5. If you do not want to store the radio station found, return to Step 3 and search for another station.
Otherwise:
 - a. Press the **ENTER** button.
 - b. Or, press the **TUNING** **◀◀** or **▶▶** button on the remote control to select a program number.
 - c. Press the **ENTER** button to save the preset.
6. To store additional radio frequencies, repeat Steps 3 through 5.

➤ In Tuner mode

- In the Manual mode, you can use the **◀◀** or **▶▶** button on the main unit to manually search for a radio station.
- In the Preset mode, you can use the **◀◀** or **▶▶** button on the main unit to search for a stored radio station. See below.

▶ Selecting a Stored Station

You can listen to a stored radio station.

1. Press the **SOURCE** button on the remote control or the (📻) button on the product's front panel repeatedly until "📻 FM" appears.
2. Press the **TUNING MODE** button on the remote control until "PRESET" is displayed.
3. Press the **◀◀** or **▶▶** button on the main unit or the **TUNING** **◀◀** or **▶▶** on the remote control to select a desired preset number.

THE RECORDING FUNCTION

You can record from a radio broadcast, USB device, or an external source to a USB storage device.

1. Connect an external USB storage device to the USB 2 **REC** port on your product.
2. Tune to a station or connect an external source to your product.

Tuner

- Select **FM** by pressing the **SOURCE** button on the remote control or the (**FM**) button on the product's front panel.
- Tune to a station you want to record.

External Source

- Connect an External Component/MP3 player to your product.
- Press the **SOURCE** button on the remote control or the (**FM**) button on the product's front panel repeatedly to select < **AUX 1** > input or < **AUX 2** > input.
- Play a song from the external device.

USB 1

- Connect a USB device to the USB 1 jack of your product
- Press the **SOURCE** button on the remote control or the (**FM**) button on the product's front panel repeatedly to select < **USB 1** > input.
- Play a song from USB 1.

3. Press the **USB REC** button on the remote control to start recording.

USB 1

- Press the **USB REC** button on the remote control. The currently playing file is copied onto the USB 2 device.
- Press and hold the **USB REC** button. All the files in the current folder are copied onto the USB 2 device. "COPY" is displayed. When the recording is done, "■" will be displayed.
- If there is a duplicate file name, "FILE EXIST" is displayed, and the function is canceled.

Tuner

- "FM RECORD" is displayed.

External Source

- "AUX RECORD" is displayed.

4. To stop recording, press the **STOP** (■) button on the remote or the **PLAY/PAUSE** (▶) button on the product's front panel. The unit automatically creates and saves recorded files in .MP3 format (SAM-XXXX.MP3). After recording, a directory named "COPY"(USB), "TUNER RECORDING" or "AUX RECORDING" is created on your USB device.



- Do not disconnect the USB device or the AC Cord during recording as this may cause damage to the file.
- If you disconnect the USB device during a recording, the unfinished recording file may get damaged and cannot be deleted. If this occurs, connect the USB device to a PC, backup the data stored in the USB, and then format it.

- When the USB memory has insufficient free space, the system will display "NOT ENOUGH MEMORY".
- The USB device or HDD you are recording to must be formatted in the FAT file system. The NTFS file system is not supported.
- The recording time may be longer with some USB devices.
- The REPEAT and SOUND EFFECT functions are set to "OFF" automatically and are not available during recording.
- Note that setting the input level too loud when recording music from an external device through the AUX or USB channel may cause noise in the recording. If this occurs, lower the external device's volume level.
- The maximum TUNER/AUX recording time is 5 hours.

SOFTWARE UPGRADE

Samsung may offer upgrades for the Wireless Audio - SoundTower system firmware in the future.

If an upgrade is offered, you can upgrade the firmware by connecting a USB drive with the firmware upgrade stored on it to the USB port on your product.

Note that if there are multiple upgrade files, you must load them onto the USB drive singly and use them to upgrade the firmware one at a time.

Please visit Samsung.com or contact the Samsung Call Center to receive more information about downloading upgrade files.

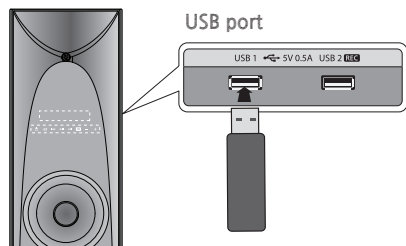

- Insert a USB drive containing the firmware upgrade into the USB port on the main unit.
- Do not disconnect the power or remove the USB drive while upgrades are being applied. The main unit will turn off automatically after completing the firmware upgrade.
- When software is upgraded, settings you have made will return to their default (factory) settings.
- We recommend you write down your settings so that you can easily reset them after the upgrade.
- Once the software upgrade is completed, turn on the product and then press and hold the (■) button for a while in USB 1 mode to reset the product.
- If the firmware fails to upgrade, we recommend formatting the USB device in FAT16 and trying again.
- Do not use a USB thumb drive formatted in the NTFS format to upgrade the SoundTower. For upgrading purposes, the SoundTower does not support the NTFS format.
- Depending on the manufacturer, some USB devices may not be supported.

TROUBLESHOOTING

Refer to the table below when this product does not function properly. If the problem you are experiencing is not listed below or if the instructions below do not help, turn off the product, disconnect the power cord, and then contact the nearest authorized dealer or Samsung Electronics Service Centre.

The unit will not turn on.	
• Is the power cord plugged into the outlet?	→ Connect the power plug to the outlet.
A function does not work when the button is pressed.	
• Is there static electricity in the air?	→ Disconnect the power plug and connect it again.
Sound is not produced.	
• Is the Mute function on?	→ Press the Mute button to cancel the function.
• Is the volume set to minimum?	→ Adjust the volume.
The remote control does not work.	
• Are the batteries drained?	→ Replace with new batteries.
• Is the distance between the remote control and main unit too far?	→ Move closer to the unit.
The TV SoundConnect (TV pairing) failed.	
• Does your TV support TV SoundConnect?	→ TV SoundConnect is supported by some Samsung TVs released after 2012. Check your TV to see if it supports TV SoundConnect.
• Is your TV firmware the latest version?	→ Update your TV with to latest firmware.
• Does an error occur when connecting?	→ Reset the TV MODE and connect again. → Press and hold the ENTER () button for 5 seconds to reset the TV SoundConnect connection.
	→ Contact the Samsung Call Center.
Can't receive radio broadcasts.	
• Is the antenna connected properly?	→ If the antenna's input signal is weak, install an external FM antenna in an area with good reception.

APPENDIX

SPECIFICATIONS

Model name	TW-J5500		
GENERAL	USB		5 V/0.5 A
	Weight	Main unit	31.97 lbs
		Speaker	29.1 lbs
	Dimensions (W x H x D)	Main unit	7.95 × 38.6 × 11.6 inches
		Speaker	7.95 × 38.6 × 11.1 inches
	Operating temperature range		+41°F to +95°F (+5 °C to +35 °C)
	Operating humidity range		10 % to 75 %
AMPLIFIER	Rated output power	Front Speak	75 W (THD = 10 %, 2 kHz)
		Subwoofer	100 W (THD = 10 %, 100 Hz)
	S/N ratio (analog input)		65 dB
	Separation (1kHz)		50 dB

- * S/N ratio, distortion, separation, and usable sensitivity are based on measurements using AES (Audio Engineering Society) guidelines.
- * Nominal specification
 - Samsung Electronics Co., Ltd reserves the right to change the specifications without notice.
 - Weight and dimensions are approximate.
 - Dispose unwanted electronics through an approved recycler.
To find the nearest recycling location, go to our website, www.samsung.com/recyclingdirect, or call (877) 278 - 0799

Open Source Announcement

To send inquiries and requests regarding open sources, contact Samsung via Email (oss.request@samsung.com).

Important Note About Service

- An administration fee may be charged if either:
 - a. An engineer is called out to your home at your request and there is no defect in the product.
 - b. You bring the unit to a repair center and there is no defect in the product.
- You will be advised of the amount of the administration fee before any work is done or a home visit is made.
- If you have a problem with this product, we strongly recommend you read the appropriate section of this manual, review the Troubleshooting section on page 19, visit the Support page for your product at www.samsung.com, or call Samsung Product Support (1-800-726-7864) to find an answer before you contact a service center for a repair.

WARRANTY

LIMITED WARRANTY TO ORIGINAL PURCHASER

This SAMSUNG brand product, as supplied and distributed by Samsung Electronics America, Inc. (SAMSUNG) and delivered new, in the original carton to the original consumer purchaser, is warranted by SAMSUNG against manufacturing defects in materials and workmanship for a limited warranty period of:

One (1) Year Parts and Labor* (*90 Days Parts and Labor for Commercial Use)

This limited warranty begins on the original date of purchase, and is valid only on products purchased and used in the United States. To receive warranty service, the purchaser must contact SAMSUNG for problem determination and service procedures. Warranty service can only be performed by a SAMSUNG authorized service center. The original dated bill of sale must be presented upon request as proof of purchase to SAMSUNG or SAMSUNG's authorized service center. Transportation of the product to and from the service center is the responsibility of the purchaser.

SAMSUNG will repair or replace this product, at our option and at no charge as stipulated herein, with new or reconditioned parts or products if found to be defective during the limited warranty period specified above. All replaced parts and products become the property of SAMSUNG and must be returned to SAMSUNG. Replacement parts and products assume the remaining original warranty, or ninety (90) days, whichever is longer.

SAMSUNG's obligations with respect to software products distributed by SAMSUNG under the SAMSUNG brand name are set forth in the applicable end user license agreement. Non-SAMSUNG hardware and software products, if provided, are on an "AS IS" basis. Non-SAMSUNG manufacturers, suppliers, publishers, and service providers may provide their own warranties.

This limited warranty covers manufacturing defects in materials and workmanship encountered in normal, and except to the extent otherwise expressly provided for in this statement, noncommercial use of this product, and shall not apply to the following, including, but not limited to: damage which occurs in shipment; delivery and installation; applications and uses for which this product was not intended; altered product or serial numbers; cosmetic damage or exterior finish; accidents, abuse, neglect, fire, water, lightning or other acts of nature; use of products, equipment, systems, utilities, services, parts, supplies, accessories, applications, installations, repairs, external wiring or connectors not supplied and authorized by SAMSUNG, or which damage this product or result in service problems; incorrect electrical line voltage, fluctuations and surges; customer adjustments and failure to follow operating instructions, cleaning, maintenance and environmental instructions that are covered and prescribed in the instruction book; product removal or reinstallation; reception problems and distortion related to noise, echo, interference or other signal transmission and delivery problems. SAMSUNG does not warrant uninterrupted or error-free operation of the product.

THERE ARE NO EXPRESS WARRANTIES OTHER THAN THOSE LISTED AND DESCRIBED ABOVE, AND NO WARRANTIES WHETHER EXPRESS OR IMPLIED, INCLUDING, BUT NOT LIMITED TO, ANY IMPLIED WARRANTIES OF MERCHANTABILITY OR FITNESS FOR A PARTICULAR PURPOSE, SHALL APPLY AFTER THE EXPRESS WARRANTY PERIODS STATED ABOVE, AND NO OTHER EXPRESS WARRANTY OR GUARANTY GIVEN BY ANY PERSON, FIRM OR CORPORATION WITH RESPECT TO THIS PRODUCT SHALL BE BINDING ON SAMSUNG. SAMSUNG SHALL NOT BE LIABLE FOR LOSS OF REVENUE OR PROFITS, FAILURE TO REALIZE SAVINGS OR OTHER BENEFITS, OR ANY OTHER SPECIAL, INCIDENTAL OR CONSEQUENTIAL DAMAGES CAUSED BY THE USE, MISUSE OR INABILITY TO USE THIS PRODUCT, REGARDLESS OF THE LEGAL THEORY ON WHICH THE CLAIM IS BASED, AND EVEN IF SAMSUNG HAS BEEN ADVISED OF THE POSSIBILITY OF SUCH DAMAGES. NOR SHALL RECOVERY OF ANY KIND AGAINST SAMSUNG BE GREATER IN AMOUNT THAN THE PURCHASE PRICE OF THE PRODUCT SOLD BY SAMSUNG AND CAUSING THE ALLEGED DAMAGE. WITHOUT LIMITING THE FOREGOING, PURCHASER ASSUMES ALL RISK AND LIABILITY FOR LOSS, DAMAGE OR INJURY TO PURCHASER AND PURCHASER'S PROPERTY AND TO OTHERS AND THEIR PROPERTY ARISING OUT OF THE USE, MISUSE OR INABILITY TO USE THIS PRODUCT SOLD BY SAMSUNG NOT CAUSED DIRECTLY BY THE NEGLIGENCE OF SAMSUNG. THIS LIMITED WARRANTY SHALL NOT EXTEND TO ANYONE OTHER THAN THE ORIGINAL PURCHASER OF THIS PRODUCT, IS NONTRANSFERABLE AND STATES YOUR EXCLUSIVE REMEDY.

The benefits of this Limited Warranty extend only to the original purchaser of Samsung products from an authorized Samsung reseller. THIS LIMITED WARRANTY SHALL NOT APPLY TO ANY SAMSUNG PRODUCTS PURCHASED FROM UNAUTHORIZED RESELLERS OR RETAILERS, EXCEPT IN STATES WHERE SUCH RESTRICTION MAY BE PROHIBITED. For a list of Samsung authorized retailers, please go to: http://www.samsung.com/us/peaceofmind/authorized_resellers.html

Some states do not allow limitations on how long an implied warranty lasts, or the exclusion or limitation of incidental or consequential damages, so the above limitations or exclusions may not apply to you. This warranty gives you specific legal rights, and you may also have other rights which vary from state to state.

To obtain warranty hardware service, please contact SAMSUNG customer care center.

SAMSUNG

QUESTIONS OR COMMENTS?

Area	CALL	OR VISIT US ONLINE AT	WRITE
IN THE US	1-800-SAMSUNG (726-7864)	www.samsung.com/us/ support	Samsung Electronics America, Inc. 85 Challenger Road Ridgefield Park, NJ 07660

