

Washer

User manual

WF90F53*D*

SAMSUNG

Contents

Safety information	4
What you need to know about the safety instructions	4
Important safety symbols	4
Important safety precautions	5
CALIFORNIA PROPOSITION 65 WARNING	5
Critical installation warnings	6
Installation cautions	7
Critical usage warnings	7
Usage cautions	9
Critical cleaning warnings	12
Regulatory notice	13
FCC Notice	13
IC Notice	15
Open Source Announcement	16
Installation	17
Unpacking your washer	17
What's included	18
Installation requirements	20
Step-by-step installation	24
Before you start	29
Initial setup	29
Run Calibration (recommended)	29
Laundry guidelines	30
Detergent drawer guidelines	33
Operations	37
LCD panel	37
Operating a cycle	40
Cycle overview	42
Cycle chart	45
Settings	49
Special features	56
SmartThings	57

Maintenance	59
Product Care	59
Drum Clean+	60
Emergency drain	61
Cleaning	62
Recovery from freezing	66
Care for an extended period of non-use	66
Cleaning the exterior	67
Cleaning the interior	67
Troubleshooting	68
Checkpoints	68
Information codes	73
Specifications	75
Fabric care chart	75
Protecting the environment	76
Declaration of conformity	76
Specification sheet	77

Safety information

Congratulations on your new Samsung washer. This manual contains important information on the installation, use and care of your appliance. Please take some time to read this manual to take full advantage of your washer's many benefits and features.

What you need to know about the safety instructions

Please read this manual thoroughly to ensure that you know how to safely and efficiently operate the extensive features and functions of your new appliance. Please store the manual in a safe location close to the appliance for future reference. Use this appliance only for its intended purpose as described in this instruction manual.

Warnings and Important Safety Instructions in this manual do not cover all possible conditions and situations that may occur. It is your responsibility to use common sense, caution and care when installing, maintaining and operating your washer.

Because the following operating instructions cover various models, the characteristics of your washer may differ slightly from those described in this manual and not all warning signs may be applicable. If you have any questions or concerns, contact your nearest service center or find help and information online at www.samsung.com.

Important safety symbols

What the icons and signs in this user manual mean:

WARNING

Hazards or unsafe practices that may result in **severe personal injury, death and/or property damage**.

CAUTION

Hazards or unsafe practices that may result in **personal injury and/or property damage**.

NOTE

Indicates that a risk of personal injury or material damage exists.

These warning signs are here to prevent injury to yourself and others.

Please follow them explicitly.

After reading this manual, store it in a safe place for future reference.

Read all instructions before using the appliance.

As with any equipment that uses electricity and moving parts, potential hazards exist. To safely operate this appliance, familiarize yourself with its operation and exercise care when using it.

SAVE THESE INSTRUCTIONS

Important safety precautions

WARNING

To reduce the risk of fire, electric shock, or injury to persons when using your appliance, follow basic precautions, including the following:

1. Read all instructions before using the appliance.
2. Do not wash or dry articles that have been previously cleaned in, washed in, soaked in, or spotted with gasoline, dry-cleaning solvents, other flammable or explosive substances as they give off vapors that could ignite or explode.
3. Do not allow children to play on or in the appliance. Close supervision of children is necessary when the appliance is used near children.
4. Before the appliance is removed from service or discarded, remove the door to the washing or drying compartment.
5. Do not reach into the appliance if the drum is moving.
6. Do not install or store this appliance where it will be exposed to the weather.
7. Do not tamper with controls.
8. Do not repair or replace any part of the appliance or attempt any servicing unless specifically recommended in the user-maintenance instructions or in published user repair instructions that you understand and have the skills to carry out.
9. Do not add gasoline, dry-cleaning solvents, or other flammable or explosive substances to the wash water. These substances give off vapors that could ignite or explode.
10. Under certain conditions, hydrogen gas may be produced in a hot water system that has not been used for 2 weeks or more. HYDROGEN GAS IS EXPLOSIVE. If the hot water system has not been used for such a period, before using a washer or combination washer-dryer, turn on all hot water faucets and let the water flow from each for several minutes. This will release any accumulated hydrogen gas. As the gas is flammable, do not smoke or use an open flame during this time.

CALIFORNIA PROPOSITION 65 WARNING

WARNING

Cancer and Reproductive Harm - www.P65Warnings.ca.gov.

SAVE THESE INSTRUCTIONS

Safety information

Critical installation warnings

WARNING

The installation of this appliance must be performed by a qualified technician or service company.

- Failure to do so may result in electric shock, fire, an explosion, problems with the product, or injury.

The appliance is heavy, therefore take care when lifting it.

Plug the power cord into a wall socket that meets local electrical specifications. Use the socket for this appliance only, and do not use an extension cord.

- Sharing a wall socket with other appliances, using a power strip, or extending the power cord may result in electric shock or fire.
- Ensure that the voltage, frequency, and current supplied to the washer matches those listed in the product specifications. Failure to do so may result in electric shock or fire. Plug the power plug into the wall socket firmly.

Remove all foreign substances such as dust or water from the power plug terminals and contact points using a dry cloth on a regular basis.

- Unplug the power plug and clean it with a dry cloth.
- Failure to do so may result in electric shock or fire.

Plug the power plug into the wall socket so that the cord is running towards the floor.

- If you plug the power plug into the socket in the opposite direction, the electric wires within the cable may be damaged and this may result in electric shock or fire.

Keep all packaging materials out of the reach of children as these may be dangerous.

- If a child places a plastic bag over his or her head, he or she can suffocate.

If the appliance, power plug, or power cord is damaged, contact your nearest service center.

This appliance must be properly grounded.

Do not ground the appliance to a gas pipe, plastic water pipe, or telephone line.

- This may result in electric shock, fire, an explosion, or problems with the product.
- Never plug the power cord into a socket that is not grounded correctly. Make sure that the socket is in accord with local and national regulations.

Do not install this appliance near a heater or any flammable material.

Do not install this appliance in a humid, oily or dusty location, or in a location exposed to direct sunlight or water (rain drops).

Do not install this appliance in a location exposed to low temperatures.

- Frost may cause the tubes to burst.

SAVE THESE INSTRUCTIONS



Do not install this appliance in a location where gas may leak.

- This may result in electric shock or fire.

Do not use an electric transformer to power the washer.

- This may result in electric shock or fire.

Do not use a damaged power plug, damaged power cord, or loose wall socket.

- This may result in electric shock or fire.

Do not pull or bend the power cord excessively.

Do not twist or tie the power cord.

Do not hook the power cord over a metal object, place a heavy object on the power cord, insert the power cord between objects, or push the power cord into the space behind the appliance.

- This may result in electric shock or fire.

Do not pull the power cord when unplugging the power plug.

- Unplug the power plug by pulling the plug.
- Failure to do so may result in electric shock or fire.

This appliance should be positioned so that the power plug, the water supply taps, and the drain pipes are accessible.

Installation cautions

CAUTION

This appliance should be positioned in such a way that the power plug is easily accessible.

- Failure to do so may result in electric shock or fire due to electric leakage.

Install your appliance on a solid, level floor that can support its weight.

- Failure to do so may result in abnormal vibrations, movement, noise, or problems with the product.

Critical usage warnings

WARNING

If the appliance is flooded, turn off the water & power supplies immediately and contact your nearest service center.

- Do not touch the power plug with wet hands.
- Failure to do so may result in electric shock.

SAVE THESE INSTRUCTIONS



Safety information

If the appliance generates a strange noise, a burning smell, or smoke, unplug the power plug immediately and contact your nearest service center.

- Failure to do so may result in electric shock or fire.

In the event of a gas leak (such as propane gas, LP gas, etc.), ventilate immediately without touching the power plug. Do not touch the appliance or power cord.

- Do not use a ventilating fan.
- A spark may result in an explosion or fire.

Do not let children play in or on the washer. In addition, when disposing of the appliance, remove the washer door lever.

- Children can suffocate to death if trapped inside the product.

Make sure to remove the packaging (sponge, styrofoam) attached to the bottom of the washer before using it.

Do not wash items contaminated with gasoline, kerosene, benzene, paint thinner, alcohol, or other inflammable or explosive substances in the washer.

- This may result in electric shock, fire, or an explosion.

Do not open the washer door by force while it is operating (high-temperature washing/drying/spinning).

- Water flowing out of the washer may result in burns or cause the floor to be slippery. This may result in injury.
- Opening the door by force may result in damage to the product or injury.

Do not insert your hand under the washer while an operation is in progress.

- This may result in injury.

Do not touch the power plug with wet hands.

- This may result in electric shock.

Do not turn the appliance off by unplugging the power plug while an operation is in progress.

- Plugging the power plug into the wall socket again may cause a spark and result in electric shock or fire.

Do not let children climb in or onto the appliance.

- This may result in electric shock, burns, or injury.

Do not insert your hand or a metal object under the washer while it is operating.

- This may result in injury.

Do not unplug the appliance by pulling the power cord. Always grip the plug firmly and pull it straight out of the outlet.

- Damage to the power cord may cause a short-circuit, fire, and/or electric shock.

Do not attempt to repair, disassemble, or modify the appliance yourself.

- Do not use a fuse (such as copper, steel wire, etc.) other than a standard fuse.
- When the appliance needs to be repaired or reinstalled, contact your nearest service center.

SAVE THESE INSTRUCTIONS

-
- Failure to do so may result in electric shock, fire, problems with the product, or injury.

If the water supply hose comes loose from the faucet and floods the appliance, unplug the power plug.

- Failure to do so may result in electric shock or fire.

Unplug the power plug when the appliance is not being used for long periods of time or during a thunder or lightning storm.

- Failure to do so may result in electric shock or fire.

If any foreign substance enters the appliance, unplug the power plug and contact your nearest Samsung Customer Service.

- This may result in electric shock or fire.

Do not let children (or pets) play in or on your washer. The washer door does not open easily from the inside and children may be seriously injured if trapped inside.

Usage cautions

CAUTION

If the washer is contaminated by a foreign substance such as detergent, dirt, food waste, etc., unplug the power plug and clean the washer using a damp, soft cloth.

- Failure to do so may result in discoloration, deformation, damage, or rust.

The front glass may be broken by a strong impact. Take care when using the washer.

- If the glass is broken, it may result in injury.

After a water supply failure or when reconnecting the water supply hose, open the faucet slowly.

Open the faucet slowly after a long period of non-use.

- The air pressure in the water supply hose or the water pipe may damage a product part or result in a water leak.

If a draining error occurs during an operation, check if there is a draining problem.

- If the washer is used when it is flooded because of a draining problem, it may result in electric shock or fire.

Insert the laundry into the washer completely so that the laundry does not get caught in the door.

- If laundry gets caught in the door, it may result in damage to the laundry or the washer, or result in a water leak.

Turn the water supply off when the washer is not being used.

- Ensure that the water supply hose connectors are properly tightened.

SAVE THESE INSTRUCTIONS

Safety information

Ensure that the rubber seal and front door glass are not contaminated by a foreign substance (e.g. waste, thread, hair, etc.).

- If a foreign substance is caught in the door or the door is not completely closed, it may cause a water leak.

Open the faucet and check if the water supply hose connectors are firmly tightened and that there are no water leaks before using the product.

- If the connectors on the water supply hoses are loose, it may result in a water leak.

The product you have purchased is designed for domestic use only.

Using the product for business purposes qualifies as a product misuse. If the product is used for business purposes, it will not be covered by the standard warranty provided by Samsung and no responsibility can be attributed to Samsung for malfunctions or damages resulting from such misuse.

Do not stand on the appliance or place objects (such as laundry, lighted candles, lighted cigarettes, dishes, chemicals, metal objects, etc.) on the appliance.

- This may result in electric shock, fire, problems with the product, or injury.

Do not spray volatile material such as insecticide onto the surface of the appliance.

- As well as being harmful to humans, this may result in electric shock, fire, or problems with the product.

Do not place objects that generate electromagnetic fields near the washer.

- This may result in injury due to a malfunction.

Water drained during a high-temperature wash or drying cycle is hot. Do not touch the water.

- This may result in burns or injury.

Do not wash, spin, or dry water-proof seats, mats, or clothing (*) unless your appliance has a special cycle for washing these items.

(*): Woolen bedding, rain covers, fishing vests, ski pants, sleeping bags, diaper covers, sweat suits, and bicycle, motor cycle and car covers, etc.

- Do not wash thick or hard mats even if the washer mark is on the care label. This may result in injury or damage to the washer, walls, floor, or clothing due to abnormal vibrations.
- Do not wash throw rugs or doormats with rubber backing. The rubber backing may come off and stick to inside the drum, and this may result in malfunction such as a drainage error.

Do not operate the washer when the detergent drawer is removed.

- This may result in electric shock or injury due to a water leak.

Do not touch the insides of the drum during or just after drying as it is hot.

- This may result in burns.

The door glass becomes hot during washing and drying. Therefore, do not touch the door glass.

SAVE THESE INSTRUCTIONS



Also, do not allow children to play around the washer or touch the door glass.

- This may result in burns.

Do not insert your hand into the detergent drawer.

- This may result in injury as your hand may be caught by the detergent input device.
- Do not use the liquid detergent container (on applicable models only) for powdered detergent. Remove the container and put powdered detergent directly into the Main wash compartment.

Do not place any objects (such as shoes, food waste, animals) other than laundry into the washer.

- This may result in damage to the washer, or injury and death in the case of pets, due to the abnormal vibrations.

Do not press the buttons using sharp objects such as pins, knives, fingernails, etc.

- This may result in electric shock or injury.

Do not wash laundry contaminated by oils, creams, or lotions usually found in skincare shops or massage clinics.

- This may cause the rubber seal to become deformed and result in a water leak.

Do not leave metal objects such as safety pins, hair pins or bleach in the drum for long periods of time.

- Doing either may cause the drum to rust.
- If rust starts appearing on the surface of the drum, apply a (neutral) cleansing agent to the surface and use a sponge to clean it. Never use a metal brush.

Do not use dry cleaning detergent directly and do not wash, rinse, or spin laundry contaminated by dry cleaning detergent.

- This may result in spontaneous combustion or ignition due to the heat from the oxidation of the oil.

Do not use water from water cooling/heating devices.

- This may result in problems with the washer.

Do not use natural hand-washing soap for the washer.

- If it hardens and accumulates inside the washer, it may result in problems with the product, discoloration, rust, or bad odors.

Place socks and brassieres in a washing net and wash them with the other laundry.

Do not wash large laundry items such as bedding in the washing net.

- Failure to do so may result in injury due to abnormal vibrations.

Do not use hardened detergent.

- If it accumulates inside the washer, it may result in a water leak.

Make sure that the pockets of all the clothing items to be washed are empty.

- Hard, sharp objects such as coins, safety pins, nails, screws, or stones can cause extensive damage to the appliance.

SAVE THESE INSTRUCTIONS



Safety information

Do not wash clothing with large buckles, buttons, or other heavy metal objects in the washer.

Sort the laundry by color on the basis of its colorfastness and select the recommended cycle, water temperature, and additional functions.

- Failure to do this may result in discoloration or fabric damage.

Take care that children's fingers are not caught in the door when you close it.

- Failure to do so may result in injury.

Critical cleaning warnings

WARNING

Do not clean the appliance by spraying water directly onto it.

Do not use a strong acidic cleaning agent.

Do not use benzene, thinner, or alcohol to clean the appliance.

- This may result in discoloration, deformation, damage, electric shock, or fire.

Before cleaning or performing maintenance, unplug the appliance from the wall socket.

- Failure to do so may result in electric shock or fire.

SAVE THESE INSTRUCTIONS

Regulatory notice

FCC Notice

CAUTION

Any changes or modifications not expressly approved by the party responsible for compliance could void the user's authority to operate the equipment.

This device complies with Part 15 of FCC Rules. Operation is Subject to following two conditions:

1. This device may not cause harmful interference, and
2. This device must accept any interference received including interference that cause undesired operation.

For products sold in the US and Canadian markets, only channels 1–11 are available. You cannot select any other channels.

FCC STATEMENT:

This equipment has been tested and found to comply within the limits for a Class B digital device, pursuant to part 15 of the FCC Rules. These limits are designed to provide reasonable protection against harmful interference in a residential installation.

This equipment generates, uses, and can radiate radio frequency energy and, if not installed and used in accordance with the instructions, may cause harmful interference to radio communications. However, there is no guarantee that interference will not occur in a particular installation. If this equipment does cause harmful interference to radio or television reception, which can be determined by turning the equipment off and on, the user is encouraged to try to correct the interference by one or more of the following measures:

- Reorienting or relocating the receiving antenna
- Increasing the separation between the equipment and receiver
- Connecting the equipment to an outlet that is on a different circuit than the radio or TV.
- Consulting the dealer or an experienced radio/TV technician for help.

FCC RADIATION EXPOSURE STATEMENT:

This equipment complies with FCC radiation exposure limits set forth for an uncontrolled environment. This equipment should be installed and operated so there is at least 8 inches (20 cm) between the radiator and your body. This device and its antenna(s) must not be colocated or operated in conjunction with any other antenna or transmitter.

SAVE THESE INSTRUCTIONS

Regulatory notice

FCC Compliance Statement (applicable models only)

Model	WF90F53ADS/WF90F53ADY
Variant model	WF90F53*D* 1st * : Letter A through Z or number 0 through 9 indicates a specific feature. 2nd * : Letter A through Z indicates the color of appliance.
Responsible Party - U.S. Contact Information	Samsung Electronics America, Inc. 700 Sylvan Avenue, Englewood Cliffs, NJ 07632 Phone : 1-800-SAMSUNG (726-7864) Internet : www.samsung.com

This device complies with Part 15 of the FCC Rules. Operation is subject to the following two conditions: (1) This device may not cause harmful interference, and (2) This device must accept any interference received, including interference that may cause undesired operation.

SAVE THESE INSTRUCTIONS

IC Notice

The term "IC" before the radio certification number only signifies that Industry Canada technical specifications were met. Operation is subject to the following two conditions:

1. This device may not cause interference, and
2. This device must accept any interference, including interference that may cause undesired operation of the device.

This Class B digital apparatus complies with Canadian ICES-003.

Cet appareil numérique de la classe B est conforme à la norme NMB-003 du Canada.

For products sold in the US and Canadian markets, only channels 1–11 are available. You cannot select any other channels.

IC RADIATION EXPOSURE STATEMENT:

This equipment complies with IC RSS-102 radiation exposure limits set forth for an uncontrolled environment. This equipment should be installed and operated so there is at least 8 inches (20 cm) between the radiator and your body. This device and its antenna(s) must not be colocated or operated in conjunction with any other antenna or transmitter.

SAVE THESE INSTRUCTIONS

Regulatory notice

Open Source Announcement

The software included in this product contains open source software. You may obtain the complete corresponding source code for a period of three years after the last shipment of this product by contacting our support team via <http://opensource.samsung.com> (Please use the "Inquiry" menu.)

It is also possible to obtain the complete corresponding source code in a physical medium such as a CD-ROM; a minimal charge will be required.

The following URL http://opensource.samsung.com/opensource/SMART_AT_051/seq/0 leads to the open source license information as related to this product. This offer is valid to anyone in receipt of this information.



NOTE

Hereby, Samsung Electronics, declares that the radio equipment type appliance is in compliance with Directive 2014/53/EU. The full text of the EU declaration of conformity is available at the following internet address: The official Declaration of conformity may be found at <http://www.samsung.com>, go to Support > Search Product Support and enter the model name.

Wi-Fi max transmitter power : 20 dBm at 2.412 GHz – 2.472 GHz

SAVE THESE INSTRUCTIONS

Installation

Follow these instructions carefully to ensure proper installation of the washer and to prevent accidents when doing laundry.

WARNING

Certain internal parts are intentionally not grounded and may present a risk of electric shock only during servicing. Service personnel – Do not contact the following parts while the appliance is energized: Control board, heat sink, motor, inlet valve and pump.

Unpacking your washer

Unpack your washer and inspect it for shipping damage. Make sure you have received all the items shown on the next page. If your washer was damaged during shipping, or you do not have all of the items, call 1-800-SAMSUNG (1-800-726-7864). To prevent personal injury or strain, wear protective gloves whenever lifting or carrying the unit.

WARNING — Packing materials can be dangerous to children; Keep all packing material (plastic bags, polystyrene, etc.) well out of children's reach.

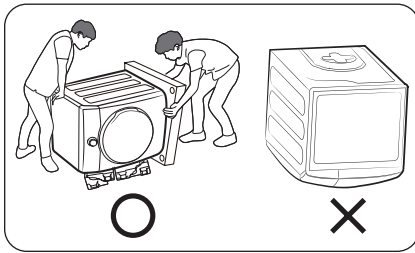

CAUTION

You must have at least 2 people unpack the washer. To remove the bottom cushion of the packing materials, do not tip the washer over on its front side. When removing the bottom cushion, be sure the shipping bolts are attached to the product. Otherwise, the leveling feet may detach, causing vibration and noise. When you lay the washer down to remove the carton base, protect the side of the washer and lay it down carefully. Never lay your washer on its back or front.

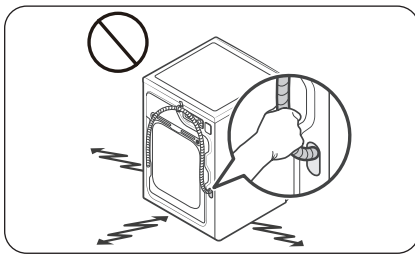

CAUTION

Do not grab or pull the drain hose to drag and move the product.

Installation

What's included

Make sure all the parts are included in the product package. If you have a problem with the washer or the parts, contact a local Samsung customer center or the retailer.

NOTE

The appearance of the actual product may differ from the image shown.

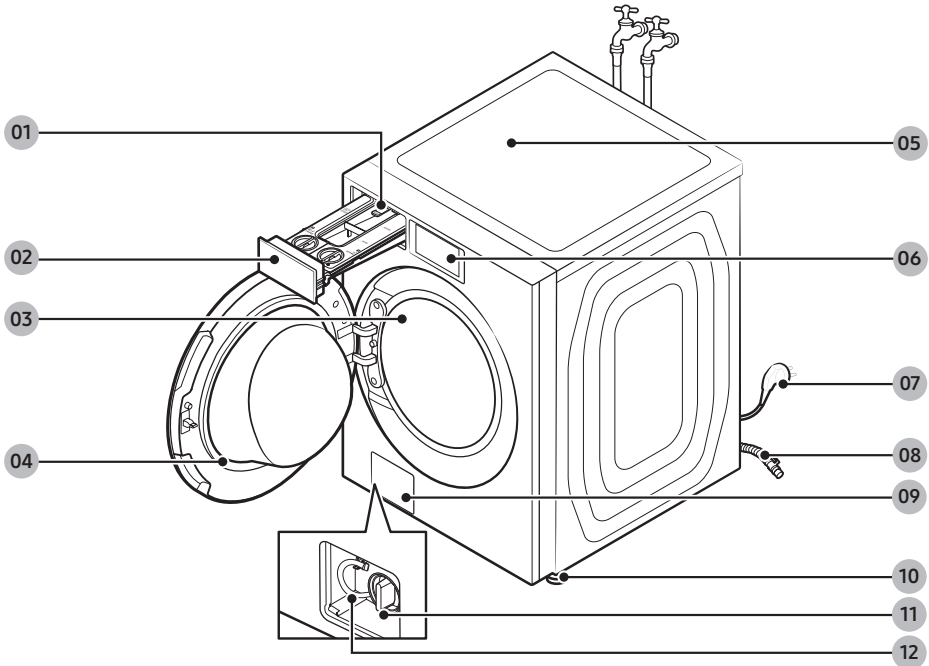

01 Release lever

02 Detergent drawer (Auto dispenser)

03 Drum

04 Door

05 Worktop

06 Multi-control panel

07 Power plug

08 Drain hose

09 Filter cover

10 Levelling feet

11 Drain filter

12 Emergency drain tube

Parts supplied



Wrench



Bolt caps



Hose guide



Cable tie



Anti-slip pads

Parts not supplied

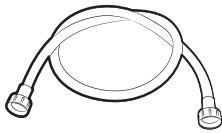

Water hoses (sold separately)

Tools needed for installation

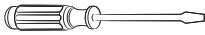

Phillips screwdriver

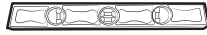

Level



Adjustable pliers

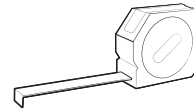

Measuring tape

NOTE

- Bolt caps: The number (3 to 6) of bolt caps provided depends on the model.
- The appearance of the washer and provided accessories may differ with the model.
- To purchase an accessory or lost part, contact a local Samsung service center or the retailer.

CAUTION

- Do not reuse old water hoses, which may leak or burst, causing flooding and/or property damage.
- Make sure rubber washers are inserted in each coupling of both water hoses.

Installation

Installation requirements

Electrical supply and grounding

- AC 120 V / 60 Hz / 15 AMP fuse or circuit breaker is required.
- Use an individual branch circuit. Connect only the washer to the circuit.

To ensure proper grounding, the washer comes with a power cord featuring a three-prong grounding plug for use in a properly installed and grounded outlet.

Check with a qualified electrician or service person if you are not sure about the grounding.

Do not modify the provided plug. If it does not fit the outlet, call a qualified electrician to install a proper outlet.

WARNING

- Do NOT use an extension cord.
- Use only the power cord that comes with the washer.
- Do NOT connect the ground wire to plastic plumbing, gas lines, or hot water pipes.
- Improperly connected grounding conductors may cause electric shock.
- To prevent unnecessary risk of fire, electrical shock, or personal injury, all wiring and grounding must be done in accordance with local codes, or in the absence of local codes, in accordance with the National Electrical Code, ANSI/NFPA No. 70-Latest Revision (for the U.S.) or the Canadian Electrical Code CSA C22.1 – Latest Revisions and local codes and ordinances. It is your responsibility to provide adequate electrical service for your washer.

Water supply

Proper water pressure for this washer is between 20-116 psi (137-800 kPa). Water pressure less than 20 psi (137 kPa) may cause the water valve not to close completely. Or, it may take longer to fill the drum, causing the washer to turn off. Water taps must be within 4 ft. (122 cm) from the rear of the washer so that the inlet hoses reach the washer.

To reduce the risk of leaks:

- Make sure water taps are easily accessible.
- Turn off the taps when the washer is not in use.
- Check for any leaks at the water inlet hose fittings on a regular basis.

CAUTION

Before using the washer for the first time, check all connections at the water valve and taps for any leaks.

Drain

Samsung recommends a standpipe 18 in. (460 mm) high. The drain hose must be connected through the hose clip to the standpipe, and the standpipe must fully cover the drain hose.

Flooring

For best performance, the washer must be installed on a solid floor. Wood floors may need to be reinforced to minimize vibration and/or unbalanced loads. Carpeting and soft tile surfaces do not provide good resistance to vibrations and may cause the washer to move slightly during the spin cycle.



CAUTION

Do NOT install the washer on a platform or a poorly supported structure.

Water temperature

Do not install the washer in areas where water may freeze as the washer always retains some water in its water valves, pumps, and/or hoses. Frozen water can cause damage to belts, the pump, and other components of the washer.

Dimensions

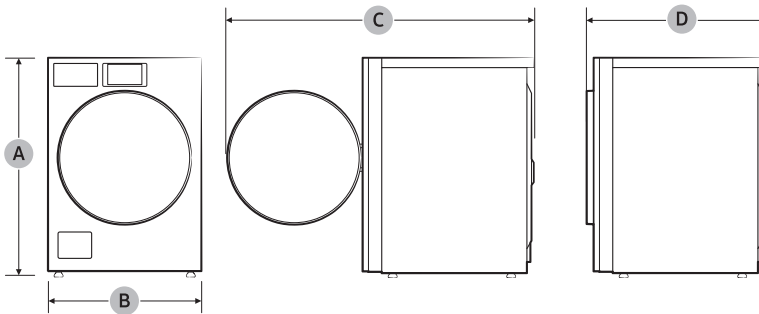

A. Overall height	38.7 in. (984 mm)
B. Width	27 in. (686 mm)
C. Depth with door open	56.3 in. (1430 mm)
D. Depth	34.5 in. (875 mm)

Installation

Clearance requirement

This clearance requirement is applicable for washers only.

NOTE

- For dryer's clearance requirement, see the dryer's user manual.
- If the washer and dryer have different clearance requirements, use the one with the larger value.

Alcove or closet installations

Minimum clearance for stable operation:

Sides	Top	Rear	Front
1 in. (25 mm)	1 in. (25 mm)	2 in. (50 mm)	1 in. (25 mm)

If both the washer and a dryer are installed in the same location, the front of the alcove or closet must have two unobstructed air openings for a combined minimum total area of 72 in.² (465 cm²).

Undercounter installation

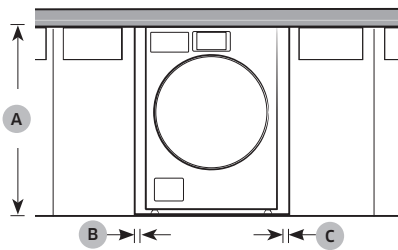

A	39.6 in. (1006 mm)
B	1 in. (25 mm)
C	1 in. (25 mm)

Pedestal installation

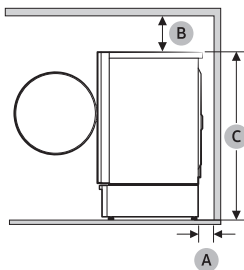

A	2 in. (50 mm)
B	6 in. (152 mm)
C	52.8 in. (1341 mm)

This clearance requirement is applicable for washer and dryer pair installation.

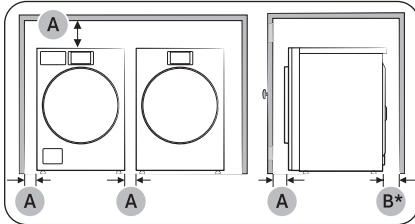

Side by side installation

A	1 in. (25 mm)
B	2 in. (50 mm) * This clearance requirement only applies to the washer. For dryer's clearance requirement, see the dryer's user manual.
C	2 in. (50 mm)
D	6 in. (152 mm)
E	77.6 in. (1971 mm)

NOTE

If you install a new dryer next to the washer you have been using, the dryer may stick out at front more than the washer.

WARNING

- Samsung's washers and dryers can be stacked to maximize usable space.
- The dryer feet need to be removed to stack the washer and dryer. You can purchase an optional stacking kit from your Samsung retailer.
 - SKK-RWG

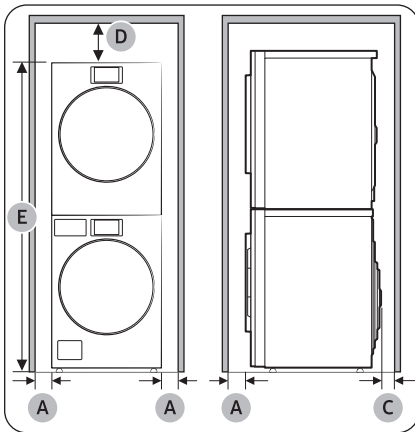

Stacked installation

Installation

Step-by-step installation

STEP 1 Select a location

Location requirements:

- A solid, level surface without carpeting or flooring that may obstruct ventilation
- No direct sunlight
- Adequate room for ventilation and wiring
- Ambient temperature always higher than the freezing point (32 °F / 0 °C)
- Away from heat sources

STEP 2 Remove the shipping bolts

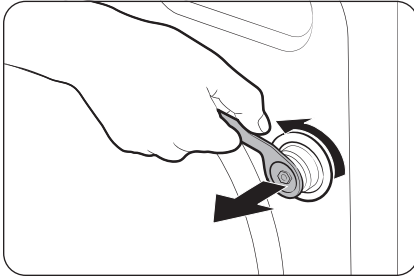

1. After unpack the product and remove all shipping bolts.

NOTE

Use the enclosed end of the supplied wrench to remove the shipping bolts.

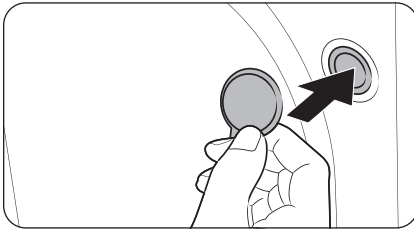

2. Fill the holes with the supplied plastic bolt caps. Keep the shipping bolts for future use.

⚠ WARNING

- The shipping bolts secure the tub during product transportation and reduce the chance of suspension damage. Remove the shipping bolts before using the product and only reinsert them if you need to move the product.
- Packaging materials can be dangerous to children. Dispose all packaging material (plastic bags, polystyrene, etc.) out of children's reach.

STEP 3 Adjust the leveling feet

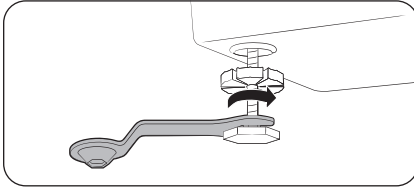

1. Gently slide the washer into position. Excessive force may damage the leveling feet.
2. Using a wrench, turn the leveling feet clockwise or counterclockwise to adjust the height until the washer is level.

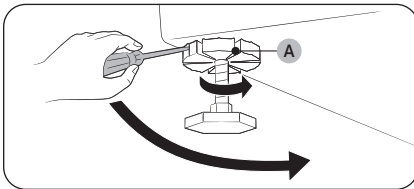

3. Using a flathead screwdriver, tighten the **locking nuts (A)**.

NOTE

Use the open-end of the supplied wrench to adjust the leveling feet.

STEP 4 Connect the water hose

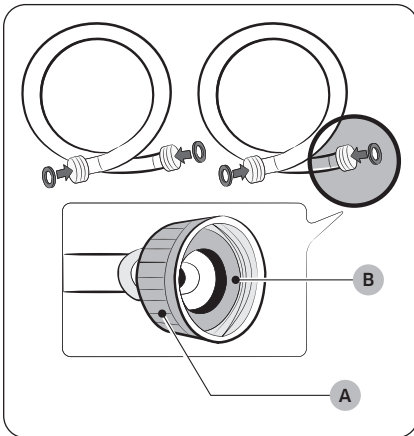

CAUTION

- Make sure to use new water hoses and that **rubber gaskets (B)** are inside the **couplings (A)** at both ends of the hoses. Water hoses without the gaskets may leak.
- Allow 5 in. (127 mm) of space between the back of the washer and the wall to prevent water hoses from being kinked. Kinked hoses may cause water leaks.
- If there is a water leak, stop using the washer and contact a local Samsung service center. A water leak may cause electric shock.
- Do not stretch the water hoses by force. If a hose is too short, replace the hose with a longer hose.

Installation

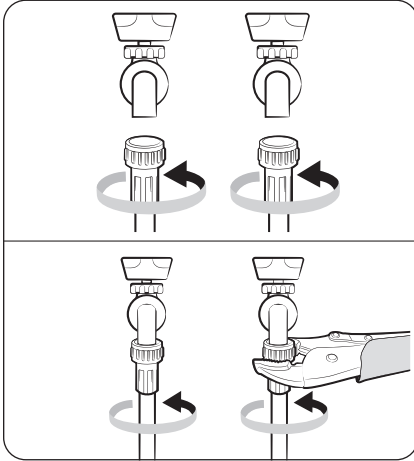

1. Attach the water hoses to the hot and cold water taps, and then hand tighten the water hose fittings until they are tight. Then, use pliers to tighten the fittings by an additional two-thirds of a turn. To avoid damaging the fittings, do not overtighten them.
2. Pull the water hoses to check if they are firmly connected.

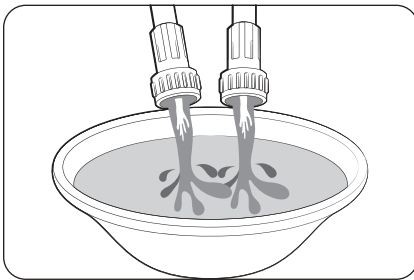

3. Put the other ends of the hoses into a bucket, and then open the water taps for 10 - 15 seconds to remove impurities. When done, close the taps.

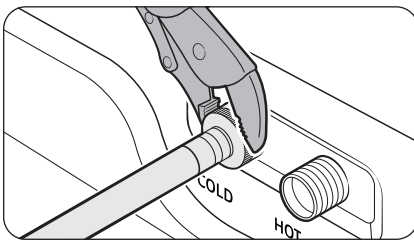

4. Attach the water hoses to the hot and cold water inlets on the back of the washer, and then hand tighten the water hose fittings until they are tight. Then, use pliers to tighten the fittings by an additional two-thirds of a turn.

NOTE

If you do not want to use the hot water supply hose, attach the water intake cap to the hot water supply intake. When you do a wash, press **Temp.** to select Cold.

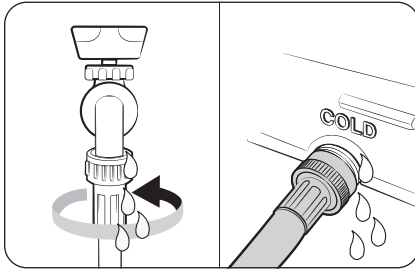

5. Open the water taps, and check for leaks.

STEP 5 Connect the drain hose

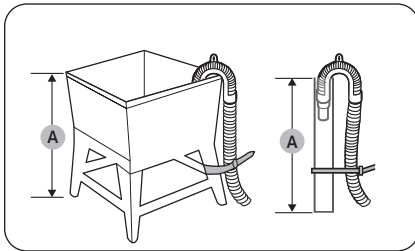

To a Laundry Tub or Drain Pipe

1. Check the **height (A)** of your drain system and make sure the minimum and maximum heights shown below are met.

Minimum	18 in. (46 cm)
Maximum	96 in. (245 cm)

NOTE

- Make sure to measure the height from the floor where the washer is placed.
- Draining efficiency may be reduced if the drain system is at the maximum height.
- To prevent the washer from siphoning water, do not use a drain system below the minimum height.

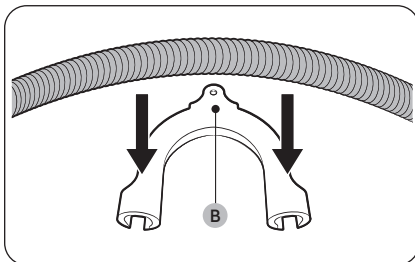

2. Attach the drain hose to the **plastic hose guide (B)**.

Installation

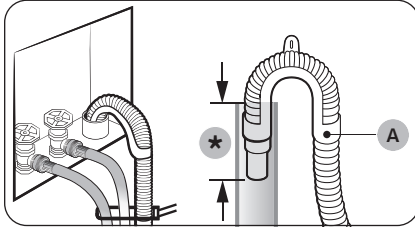

(*): Min. 6 in. (152 mm), Max. 8 in. (203 mm)

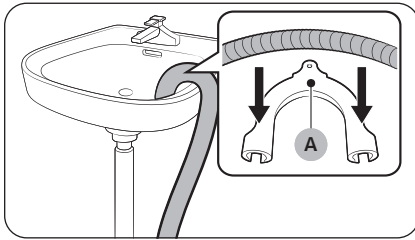

3. Route the drain hose to the drain system.

⚠ CAUTION

- If using a standpipe, make sure the standpipe and drain hose connection is not airtight.
 - If using a standpipe, make sure the drain hose is inserted at least 6 in. (152 mm) but no more than 8 in. (203 mm) into the standpipe.
4. Secure the drain hose with cable ties.

Over the edge of a wash basin

The drain hose must be placed no lower than 24 in. (60 cm) and no higher than 35 in. (90 cm) from the floor. To keep the spout of the drain hose bent, use the supplied plastic **hose guide (A)**. Secure the guide to the wall using a hook to ensure stable drainage.

STEP 6 Remove the film inside the door

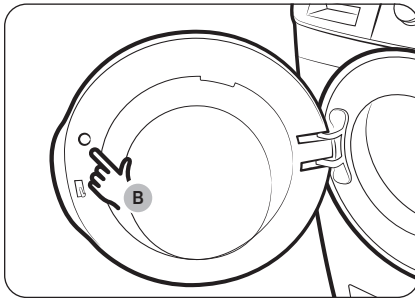

Remove the **small circle of film (B)** above the door latch before use.

STEP 7 Power on

Plug the power cord into an AC 120 V / 60 Hz / 15 AMP approved electrical outlet protected by a fuse or circuit breaker. Then, press **Power** to turn on the washer.

Before you start

Initial setup



- When you turn on the washer for the first time, the screen shows the initial setup process. Follow the on-screen instructions to complete it.
- Once you select a language, the language selection screen will not reappear. However, you must complete a wash cycle once to stop the tutorial screen from reappearing.
 - You can change the language settings by swiping down from the top of the home screen to access the Quick Panel, then tapping  > **General** > **Language**.
- The initial setup includes language selection and a brief tutorial.
- Tap **OK** to skip to the next screen.

NOTE

You can adjust the desired settings by selecting  > **General** from the Quick Panel or reset the product to try running the initial setup process by selecting  > **General** > **Reset** > **Reset all settings**.

Run Calibration (recommended)

Calibration ensures accurate weight detection by the washer. Make sure the drum is empty before running calibration.

1. Tap  to turn the power on.
2. Swipe down to enter the Quick Panel.
3. Tap  > **Washer** > **Calibration**.
4. Tap **Start Calibration** to start the calibration.

Before you start

Laundry guidelines

STEP 1 Sort

Sort the laundry according to these criteria:

- Care Label: Sort the laundry into cottons, mixed fibers, synthetics, silks, wools, and rayon.
- Color: Separate whites from colors.
- Size: Mixing different sized items together in the drum improves the washing performance.
- Sensitivity: Wash delicate items separately. For pure, new woolen items, curtains, and silk items, check the labels on the items.

 **NOTE**

Make sure to check the care label on all clothing, and sort clothing accordingly before starting the wash.

STEP 2 Empty pockets

Empty all the pockets of your laundry items

- Metal objects such as coins, pins, and buckles on clothing may damage other laundry items as well as the drum.

Turn clothing with buttons and embroideries inside out

- If pants or jacket zippers are open while washing, the drum may be damaged. Zippers should be closed and fixed with a string.
- Clothing with long strings may become entangled with other clothes. Make sure to tie the strings before starting the wash.

STEP 3 Use a laundry net

- Brassieres (water washable) must be placed in a laundry net. Metal parts of the brassieres may break through and tear other laundry items.
- Small, light clothing such as socks, gloves, stockings, and handkerchiefs may become caught around the door. Place them inside a fine laundry net.
- Do not wash the laundry net by itself without other laundry. This may cause abnormal vibrations that could move the washer and result in injury.

STEP 4 Determine the load capacity

Do not overload the washer. Overloading may cause the washer to wash improperly.

NOTE

When washing bedding or bedding covers, the wash time may be lengthened or the spin efficiency may be reduced.

For bedding or bedding covers, the recommended maximum spin level is Level 2 or Level 3, and the load capacity is 7 lb (3.0 kg) or less.

CAUTION

If the laundry is unbalanced and the "**Unbalanced load detected**" information code is displayed, redistribute the load. Unbalanced laundry may reduce spinning performance.

STEP 5 Add the correct detergent type

The type of detergent you use - general purpose, specifically for woolens, etc. - depends on the type of fabric (cotton, synthetic, delicate items, wool), color, wash temperature, and degree of soiling. Regardless of the specific type of detergent you use, always use "low suds" HE laundry detergent which is designed for automatic washers.

NOTE

- Follow the detergent manufacturer's recommendations based on the weight of the laundry, the degree of soiling, and the hardness of the water in your local area. If you are not sure about the water hardness, contact your local water authority.
- Do not use detergent that tends to harden or solidify. This detergent may remain after the rinse cycle, blocking the drain outlet.

CAUTION

When washing wool using the Wool cycle, use only a neutral liquid detergent. Powdered detergent used with the Wool cycle can remain on the laundry and discolor it.

Before you start

Use HE detergent only



For the best cleaning results, use a high efficiency detergent such as Tide HE, Wisk HE, Cheer HE or Gain HE*. High efficiency detergents contain suds suppressors that reduce or eliminate suds. When fewer suds are produced, the load tumbles more efficiently and cleaning is maximized. (* Brand names are trademarks of their respective manufacturers.)

WARNING

For best results, use HE detergents only. Do not use non-HE detergent, organic detergent, natural detergent or HE detergents with natural ingredients (such as vinegar, baking soda).

Detergent drawer guidelines

NOTE

Automatic dispensers make laundry easier by dispensing the preset amount of washing agents without you having to pour it in every time, and it could be more economical because the exact amount will be dispensed each time of use, allowing less waste of washing agents.

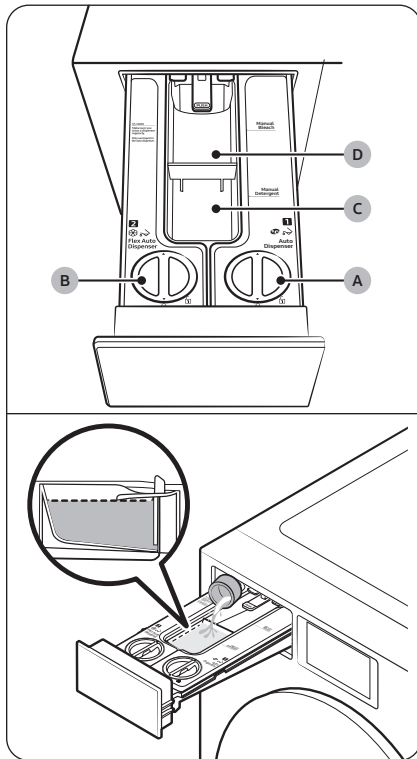

A. Dispenser 1

- You can use the general detergent in this compartment.
- Use liquid detergent only. Do not put powdered detergent or softener.

B. Dispenser 2

- You can set this dispenser to dispense detergent (General or Specialty) or softener.
- Use only neutral detergent in this dispenser if you have set the **Detergent type** to **Specialty**.
- Do not put powdered detergent.

C. Manual detergent compartment

- To use the Manual detergent dispenser, set the **Amount** option for **Dispenser 1** and **Dispenser 2** to **Off**.
- Insert the liquid detergent guide into the dispenser to use the liquid detergent. Do not put powdered detergent or softener.
- Remove the liquid detergent guide from the dispenser to use powdered detergent. Do not put liquid detergent or softener.

D. Manual bleach compartment

- Add liquid chlorine bleach. Do not exceed the max line.

Before you start

CAUTION

- Do not operate the washer without the dispensers in the detergent drawer.
 - A water leak may cause electric shock or injury.
- Do not use the following types of detergent in the drawer.
 - Tablet, capsule, ball, or net types.
- Do not use gel-type or viscous detergent/softener in the detergent drawer as they may not flow well.
 - Read the detergent/softener manufacturer's instructions before using them in the washer.
- Do not carry around the dispenser removed from the detergent drawer. Put the dispenser back in place.
 - Otherwise, the dispenser may shake and cause the content to spill out.
- Empty the dispensers in the detergent drawer before moving the washer to prevent any content from spilling out on the floor.

NOTE

- If the message "**Needs refill**" appears on the display, refill the corresponding dispenser.
- The detergent/softener is not automatically dispensed in the Outdoor, Wool, Delicates, and Activewear cycles if the **Detergent type** for Dispenser 1 and Dispenser 2 are set to **General**. You must put the detergent/softener manually in the manual detergent compartment when using those cycles.
 - However, if the **Detergent type** for Dispenser 2 is set to **Specialty**, the detergent will be dispensed automatically.
- Do not exceed the max line when filling detergent and softener.
- Push the detergent drawer all the way to the end to close it. You will hear a click sound when the drawer is properly closed.
- If you feel the softener scent is weak, set the softener input amount to a higher level.

To apply washing agents to the auto dispenser

NOTE

- Once you refill the auto detergent/softener dispensers, the washer will start to detect the detergent/softener amount when you tap .
 - The detection time may vary depending on the type of the detergent/softener.

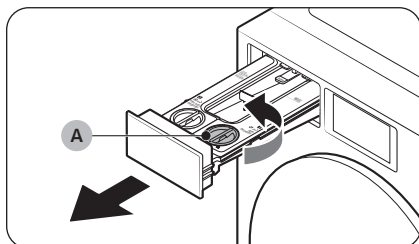

1. Press the front of the detergent drawer to open it.
2. Turn the **Dispenser 1 cap (A)** counterclockwise to open.

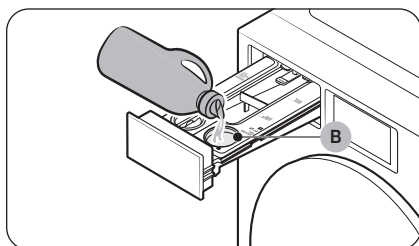

3. Apply an appropriate amount of detergent to the **Dispenser 1**.
 - After you finish, put the cap back and turn it clockwise to close.

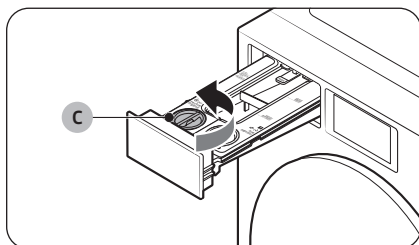

4. Turn the **Dispenser 2 cap (C)** anticlockwise to open.

Before you start

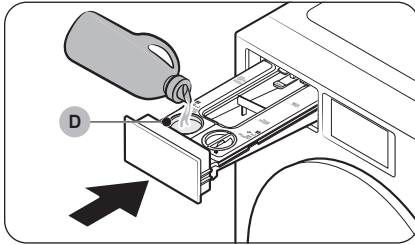

5. Apply an appropriate amount of softener to the **Dispenser 2**.
 - After you finish, put the cap back and turn it clockwise to close.
6. Push the detergent drawer to close.
 - Push the detergent drawer all the way to the end. You will hear a click sound when the drawer is properly closed.

CAUTION

- Do not apply detergent/softener to the drawer without the dispensers.
 - If you do, clean the drawer and then reinsert both dispensers.
- Only use liquid detergent or softener in the auto dispenser. Do not use powdered detergent.
- Make sure both dispensers are inserted completely.
 - If they are not, the washer may not start operating or fail to dispense washing agents.
- Clean the dispenser before refilling it with the same or a different type of detergent or softener.
- Do not leave detergent or softener in the auto dispenser for more than 6 weeks.
- Do not mix detergent with fabric softener in either dispenser.
- To prevent detergent or softener from hardening, leave the cap closed after filling the dispenser.
- Do not use any bleach that may cause corrosion and/or generate the gas.
- Do not turn any dispenser upside down.
 - The content may spill.
- Do not press the outlet at the rear of either dispenser while moving it.
 - The content may leak.
- Use caution when putting detergent or fabric softener in the applicable dispenser.
 - The content may spill.
- When removing the dispensers to check the remaining content (upon an alert message or before the message appears), the drawer may have content remaining or leaking from the bottom of the drawer.
- Make sure all the dispensers and compartments in the detergent drawer are empty before moving the washer.
- The input or refill level of the detergent/softener depends on the type or the remaining amount of detergent/softener.
- Applying detergent directly to the laundry cause discoloration. Apply detergent in the dispenser.
- Do not use hardened detergent/softener.

NOTE

- Moisture on the manual detergent compartment causes the powered detergent to stick. Therefore, wipe the moisture with dry cloth before adding the powdered detergent.
- Use detergent and bleach for washing machine only.
- Do not use gel-type or viscous detergent/softener in the detergent drawer as they may not flow well.
 - Read the detergent/softener manufacturer's instructions before using them in the washer.

Operations

⚠ WARNING

To reduce the risk of fire, electric shock, or injury to persons, read the **Safety information** before operating this washer.

LCD panel

📖 NOTE



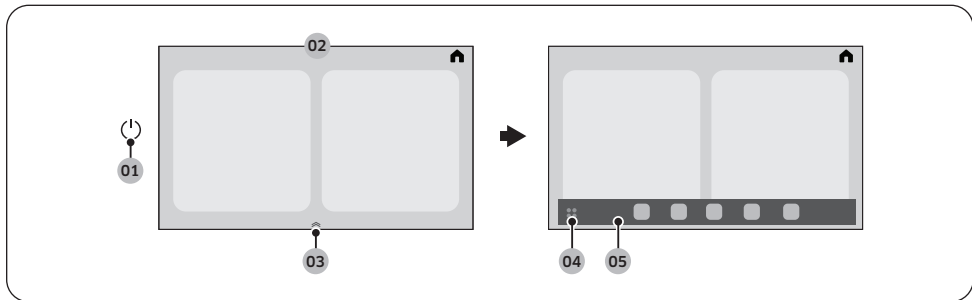





You can control the dryer from the washer's LCD panel if it is connected to the washer. Please see the dryer manual for detailed instructions on using the dryer.





01 Power	Tap to turn the washer on or off.
02 Display	The display shows current cycle information and estimated time remaining, or an information message when a problem occurs.
03 App dock handler	Drag the App dock handler upward to open the App dock. <ul style="list-style-type: none">The App dock handler only appears on the Home screen.
04 App tray button	Tap to view all available apps. <ul style="list-style-type: none">App drawer: Tap App tray to open App drawer. You can open the App drawer to quickly open the SmartThings, Timer, Bixby, Weather, Ring, Internet, or Settings app.
05 App dock	App dock displays the icons to allow easier access to the frequently used apps. <ul style="list-style-type: none">Maximum five icons are displayed in the App dock and they are editable.
06 Quick Panel	Swipe down from the top of the screen to open the Quick Panel. <ul style="list-style-type: none">The Quick Panel provides quick access to various settings.For more information on Quick Panel icons, see Display icon descriptions, see page 38.

Operations

Display icon descriptions

	Home	Tap to go to the Home screen.
	Door Lock	<ul style="list-style-type: none"> This icon indicates the door is locked and cannot be opened. The door locks automatically during a cycle and this icon turns on. You can open the door when this icon disappears.
	Smart Control	<ul style="list-style-type: none"> This icon indicates that the Smart Control is on.
	Wi-Fi	Tap to turn on or off the Wi-Fi.
	Bluetooth	<p>Tap to turn on or off the Bluetooth.</p> <ul style="list-style-type: none"> Once you turn on the Bluetooth, you can connect to Bluetooth-enabled devices near the washer.
	Microphone	Tap to turn on or off the microphone.
	Drum light	<p>Tap to turn on or off the drum light.</p> <ul style="list-style-type: none"> You can turn on the light for better visibility of the items inside the drum.
	Settings	Tap to change the General and Washer settings.
	Washer	<p>This icon appears during a washing process. Tap cycle card to change the default wash cycle settings. You can see the full option list by tapping > button.</p> <ul style="list-style-type: none"> Temp.: Tap to change the water temperature for the selected cycle. Spin: Tap to change the spin speed for the selected cycle. <ul style="list-style-type: none"> Rinse Hold & No Spin: The final rinse process is suspended so that the laundry remains in the water. To unload the laundry, run a drain or spin process. Drain & No Spin: The drum does not spin after the final drain process. Soil: Tap to change the soil level for the current cycle. Detergent: You can select the amount of the detergent to be dispensed during each wash cycle. Softener: You can select the amount of the softener to be dispensed during each wash cycle. Extra Rinse: Adds an additional rinse at the end of the cycle to remove laundry additives more thoroughly. <ul style="list-style-type: none"> Tap to turn on or off this function. Bubble Soak: This function helps remove a wide variety of stubborn stains. With Bubble Soak selected, laundry is thoroughly soaked in water bubbles for effective washing. <ul style="list-style-type: none"> Tap to turn on or off this function.

	Open Door	Tap this button to open the door. <ul style="list-style-type: none"> The button deactivates when the door is open and reactivates when the door is closed.
	Start	You can start the operation.
	Pause	You can pause the operation. <ul style="list-style-type: none"> During the operation, tap the button to pause.

Controlling the dryer from the washer LCD panel

If your washer and dryer are connected using a stacking kit (SKK-RWG), you can control the dryer directly from the washer's LCD panel.

NOTE

For detailed installation instructions, refer to the manual included with the stacking kit.

Connecting the dryer

1. Connect the washer and dryer using the provided wire in the stacking kit.
 - This step only applies to North America models.
2. Once powered on, the washer displays a pop-up to connect the dryer.
 - Tap **Add** to proceed with the connection.
 - If you accidentally tap **Don't add**, or if the pop-up does not appear, go to **Settings > Dryer connection** and search for the dryer manually.
3. Check that the same PIN appears on both the washer and dryer screens.
 - If the numbers match, tap **Connect** to complete the pairing.
4. Once connected, you can control the dryer using the washer's LCD panel
 - Ensure both the washer and dryer are powered on during use.

NOTE

If pairing fails, reset the washer and dryer by selecting **Reset network settings** or **Reset all settings**, then try again.

Disconnecting the dryer

Ensure the dryer is powered on, then go to **Settings > Dryer connection** and tap **Disconnect**.

CAUTION

If you disconnect the dryer while powered off, reset the dryer separately (**Reset network settings** or **Reset all settings**) to prevent pairing issues in the future.

Operations

Operating a cycle

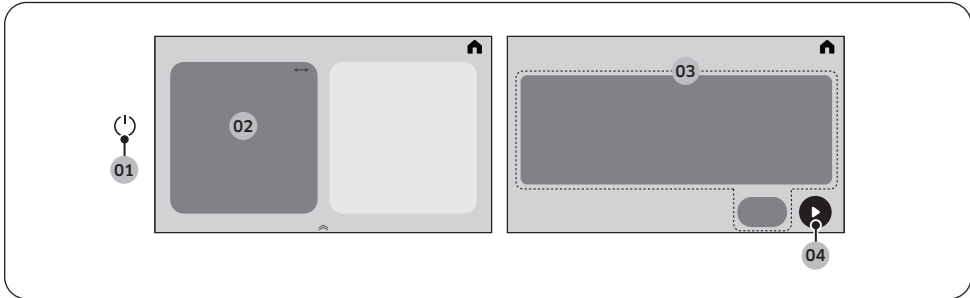

1. Tap to turn the power on.
2. Select the desired cycle.
 - For more information on **Cycle overview**, see page **42**.
3. Change the default cycle options.
 - For the washing process, tap **Temp.**, **Spin**, **Soil**, **Detergent**, **Softener**, **Extra Rinse**, or **Bubble Soak** to change the default cycle settings.
 - You can set the Delay End function.
 - Not all cycles have additional functions available.
4. Tap to start the operation.
 - Once you set the cycle you want, the screen displays brief cycle descriptions and cycle duration. You can also check the cycle progress, remaining cycle time, and information codes.

NOTE

To change the cycle, tap **More cycles**, and then select the desired cycle.

Changing the cycle settings

Tap the desired button to change the default wash cycle settings.

Temp.	Tap to change the water temperature for the selected cycle.
Spin	Tap to change the spin speed for the selected cycle. <ul style="list-style-type: none">• Rinse Hold & No Spin: The final rinse process is suspended so that the laundry remains in the water. To unload the laundry, run a drain or spin process.• Drain & No Spin: The drum does not spin after the final drain process.
Soil	Tap to change the soil level for the current cycle.
Detergent	You can select the amount of the detergent to be dispensed during each wash cycle.
Softener	You can select the amount of the softener to be dispensed during each wash cycle.
Extra Rinse	Adds an additional rinse at the end of the cycle to remove laundry additives more thoroughly. <ul style="list-style-type: none">• Tap to turn on or off this function.
Bubble Soak	This function helps remove a wide variety of stubborn stains. With Bubble Soak selected, laundry is thoroughly soaked in water bubbles for effective washing. <ul style="list-style-type: none">• Tap to turn on or off this function.

Operations

Cycle overview

Cycle descriptions

You can add or delete cycles to personalize the cycle list in the My cycles option. See page 53 for more information.

NOTE

Energy savings will vary depending on loads and cycles. Energy consumption could increase if the LCD screen is set to stay on all year long.

Cycle	Description
Normal	<ul style="list-style-type: none">For cottons, bed linens, table linens, underwear, towels, or shirts. The washing time and the rinse count are automatically adjusted according to the load.Default energy cycle for drying: Normal<ul style="list-style-type: none">To access the Normal cycle on the LCD models, turn on the power, and select Cycle > Normal.
Heavy Duty	<ul style="list-style-type: none">For sturdy, colorfast fabrics and heavily soiled items.
Bedding	<ul style="list-style-type: none">For bulky items such as comforters, blankets, and sheets.For best results, wash only 1 type of bedding.For bulky items, use liquid detergent and do not roll the items in the drum because they might get stuck in the drum.
Perm Press	<ul style="list-style-type: none">For wash-and-wear, synthetic fabrics, and lightly to normally soiled items.
Delicates	<ul style="list-style-type: none">For sheer fabrics, bras, lingerie (silk), and other handwash-only fabrics.Using specialty detergent in the Dispenser 2 is recommended.
Activewear	<ul style="list-style-type: none">For exercise wear such as sports jerseys, training pants, shirts/tops and other performance clothing. This cycle provides effective soil removal with controlled drum rotation for special fabric care.Using specialty detergent in the Dispenser 2 is recommended.
Wool	<ul style="list-style-type: none">Specific for machine-washable wool for loads less than 4 lb (2.0 kg).The Wool cycle features fine pulsating and soaking to protect the wool fibres from shrinkage/distortion.Using specialty detergent in the Dispenser 2 is recommended.
Towels	<ul style="list-style-type: none">For bath towels, washcloths, and mats.
Eco Cold	<ul style="list-style-type: none">For normally and lightly soiled items. This cycle uses only cold water to save energy. Cold water also helps prevent fabric damage.

Cycle	Description
Rinse+Spin	<ul style="list-style-type: none"> • Features an additional rinse process after fabric softener is applied to the laundry.
Drum Clean+	<ul style="list-style-type: none"> • Cleans the drum by removing dirt and build-up from the drum. • Perform once every 40 washes. • Make sure the drum is empty.
Small Load	<ul style="list-style-type: none"> • For lightly soiled items that you want to finish washing quickly. • For best performance, recommended load is 4 lb (2.0 kg) or lower.
Colors	<ul style="list-style-type: none"> • This cycle washes items in low-temperature water to prevent discoloration.
Spin Only	<ul style="list-style-type: none"> • To perform the spin process only.
AI OptiWash+	<ul style="list-style-type: none"> • The washer detects the type, weight, and soil level of your laundry, and then selects the wash cycle settings accordingly. For example, the washer will add more detergent*, washing time, and rinse count if your laundry is heavily soiled, and it will select appropriate settings to handle delicate items. <ul style="list-style-type: none"> - * : We recommend enabling the Auto Dispense function if you use the AI OptiWash+ cycle. Enable the Auto Dispense function if you want the washer to adjust the detergent amount automatically according to the soil level of your laundry. - Based on internal testing using the AI OptiWash+ cycle on an IEC 8 lb load. A turbidity sensor operates for all weight while fabric sensing operates for 8 lb and under. Actual results may vary depending on individual use.
Outdoor	<ul style="list-style-type: none"> • For outdoor clothes, skiwear, and sportswear that are made of functional materials such as spandex, stretch, and micro-fibre.
Denim	<ul style="list-style-type: none"> • Featuring a higher water level in the main wash and an extra rinse cycle to ensure that no powder detergent remains.
Super Speed	<ul style="list-style-type: none"> • The shortened time may differ depending on the load/options. • For best performance, recommended load is 10 lb (4.5 kg) or lower.
Steam Sanitize	<ul style="list-style-type: none"> • For colorfast fabrics and heavily soiled laundry, this cycle heats the supplied water over 60 °C (140 °F) to clean deeply. • If you stop running the cycle while the washer is heating the water, the door remains locked for your safety.
Steam Allergen	<ul style="list-style-type: none"> • To remove dust, pollen, and other non-living allergen substances from fabric.
Steam Normal	<ul style="list-style-type: none"> • For washing everyday garments with steam.
Steam Whites	<ul style="list-style-type: none"> • For white items. You can wash with or without bleach.

Operations

Cycle	Description
Power Rinse	<ul style="list-style-type: none">• To wash with powerful rinsing performance.
Less Microfiber	<ul style="list-style-type: none">• Use this cycle to reduce the amount of microfibers generated during washing synthetic clothes.
Tide POD Cold	<ul style="list-style-type: none">• The Tide POD Cold cycle provides deep cleaning as the detergent dissolves effectively even in cold water.• Appropriate for the household laundry loads when used with Tide Power PODs.• This cycle was co-developed with a partner company and may be replaced with a similar one or discontinued based on the contract terms with the partner.

Cycle chart

Use this chart to set the best cycle and options for your laundry.

Wash Cycle chart

● : factory setting, ○ : can be selected

Cycle	Functions				
	Temp.				
	Extra Hot	Hot	Warm	Cold	Tap Cold
Normal	○	○	●	○	○
Heavy Duty	○	●	○	○	○
Bedding			●	○	○
Perm Press			●	○	○
Delicates			○	○	●
Activewear			●	○	○
Wool			●	○	○
Towels		○	●	○	○
Eco Cold				○	●
Rinse+Spin					
Drum Clean+	●				
Small Load		○	●	○	○
Colors				●	
Spin Only					
AI OptiWash+		○	●	○	○
Outdoor			●	○	○
Denim			●	○	○
Super Speed		○	●		
Steam Sanitize	●				
Steam Allergen		●			
Steam Normal		●			
Steam Whites		●			
Power Rinse		○	●	○	○
Less Microfiber				○	●
Tide POD Cold				○	●

Operations

Cycle	Functions						
	Spin						
	Wash Only						
	Extra High	High	Medium	Low	Extra Low	Drain & No Spin	Rinse Hold & No Spin
Normal	○	●	○	○		○	○
Heavy Duty	●	○	○	○	○	○	○
Bedding			○	●	○	○	○
Perm Press		○	○	●	○	○	○
Delicates			●	○	○	○	○
Activewear				●	○	○	○
Wool				●	○	○	○
Towels	○	●	○	○	○	○	○
Eco Cold	○	●	○	○	○	○	○
Rinse+Spin	○	●	○	○	○	○	○
Drum Clean+	●						
Small Load	●	○	○	○	○	○	○
Colors	○	●	○	○		○	○
Spin Only	○	●	○	○	○	○	○
AI OptiWash+	○	●	○	○	○	○	○
Outdoor			●	○	○	○	○
Denim			●	○	○	○	○
Super Speed	○	●	○	○	○	○	○
Steam Sanitize	○	●	○	○	○	○	○
Steam Allergen	○	●	○	○	○	○	○
Steam Normal	○	●	○	○	○	○	○
Steam Whites	○	●	○	○	○	○	○
Power Rinse	○	●	○	○	○	○	○
Less Microfiber	○	●	○	○		○	○
Tide POD Cold	○	●	○	○		○	○

Cycle	Functions				
	Soil level				
	Extra Heavy	Heavy	Normal	Light	Extra Light
Normal	○	○	●	○	○
Heavy Duty	●	○	○	○	○
Bedding	○	○	●	○	○
Perm Press	○	○	●	○	○
Delicates	○	○	●	○	○
Activewear	○	○	●	○	○
Wool			●		
Towels	○	○	●	○	○
Eco Cold	○	○	●	○	○
Rinse+Spin					
Drum Clean+			●		
Small Load	○	○	○	○	●
Colors	○	○	●	○	○
Spin Only					
AI OptiWash+			●		
Outdoor	○	○	●	○	○
Denim	○	○	●	○	○
Super Speed	○	○	●	○	○
Steam Sanitize	○	○	●	○	○
Steam Allergen	○	○	●	○	○
Steam Normal	○	○	●	○	○
Steam Whites	○	○	●	○	○
Power Rinse	○	○	●	○	○
Less Microfiber	○	○	●	○	○
Tide POD Cold	○	○	●	○	○

Operations



Cycle	Functions		
	Bubble Soak	Extra Rinse	Super Speed
Normal	<input type="radio"/>	<input type="radio"/>	
Heavy Duty	<input type="radio"/>	<input type="radio"/>	<input type="radio"/>
Bedding	<input type="radio"/>	<input type="radio"/>	<input type="radio"/>
Perm Press	<input type="radio"/>	<input type="radio"/>	
Delicates		<input type="radio"/>	
Activewear	<input type="radio"/>	<input type="radio"/>	
Wool			
Towels	<input type="radio"/>	<input type="radio"/>	
Eco Cold	<input type="radio"/>	<input type="radio"/>	
Rinse+Spin		<input type="radio"/>	
Drum Clean+			
Small Load		<input type="radio"/>	
Colors	<input type="radio"/>	<input type="radio"/>	
Spin Only			
AI OptiWash+	<input type="radio"/>	<input type="radio"/>	
Outdoor		<input type="radio"/>	
Denim		<input type="radio"/>	
Super Speed		<input type="radio"/>	<input type="radio"/>
Steam Sanitize	<input type="radio"/>	<input type="radio"/>	
Steam Allergen	<input type="radio"/>	<input type="radio"/>	
Steam Normal	<input type="radio"/>	<input type="radio"/>	
Steam Whites	<input type="radio"/>	<input type="radio"/>	<input type="radio"/>
Power Rinse	<input type="radio"/>	<input type="radio"/>	
Less Microfiber	<input type="radio"/>		
Tide POD Cold	<input type="radio"/>	<input type="radio"/>	

Settings

Using Settings

1. Swipe down from the top of the screen to open the Quick Panel and tap .
2. Tap **General** or **Washer**.
3. Scroll through the screen to select the desired menu.
4. Change the settings or start the function.

NOTE



- To return to the Home screen, tap  on the top left corner, or  on the top right corner of the screen.
- If the selected function is not supported, the "**Currently not supported**" message is displayed, and the **OK** button is not activated.
- When you select an additional function, a brief help message appears for the first ten times of use.





Settings menu description

General



Options	Descriptions
Samsung Account	You can log in to your Samsung account or create a new Samsung account.
Connections	<p>You can turn the Wi-Fi on or off. You can also start the Smart Control function.</p> <ul style="list-style-type: none">• Wi-Fi: Tap to turn on or off the Wi-Fi.<ul style="list-style-type: none">- Once you turn on the washer's Wi-Fi and connect to a network, the washer remains connected to the network even when you turn off the power.- The Wi-Fi indicates that the washer is connected to the router through the Wi-Fi connection.• Easy Connection: You can easily install the SmartThings app using the displayed QR code on the screen.<ul style="list-style-type: none">- You can connect to the SmartThings app and control your washer remotely. <p> NOTE Using the functions under the Connections menu may increase power consumption.</p>

Operations



Options	Descriptions
Lock	<p>You can lock the control of the washer to prevent children or infants from accidentally starting or setting the washer.</p> <ul style="list-style-type: none"> • When Lock is enabled, the touch screen and the door become locked for safety. • You can enable/disable Lock in any selected cycle. • Press and hold the Unlock button for 3 seconds to unlock. <p> NOTE</p> <ul style="list-style-type: none"> • If you want to put additional items into the washer while Lock is enabled, you must disable the Lock function first. • You cannot open the door after a wash cycle when the Lock is on. Disable the function first, and then open the door and take out the laundry. <ul style="list-style-type: none"> - Turn on the power, tap  > General > Lock and set the function to Off. Then, you will be able to open the door.
Sounds	<p>You can set the Sound mode, Sound theme, Volume, and Voice style.</p> <ul style="list-style-type: none"> • Sound mode: You can set the desired Sound mode from Voice, Tone, and Mute. <ul style="list-style-type: none"> - If you set the Sound mode to Mute, the alert sound will not be turned off for safety purposes. • Sound theme: You can select the desired Sound theme. Tap a theme once to preview the sound. • Volume: You can adjust the volume for system and media sounds. <ul style="list-style-type: none"> - Sound mode will automatically change to Voice if you adjust the volume while the Sound mode is set to Mute. • Voice style: You can select the desired Voice style. Tap a style once to preview the sound.
Home device notifications	<p>You can turn on or off the notifications for your home devices registered on the SmartThings app.</p>
Display	<p>You can set the Brightness and Font size.</p>
Bixby	<p>You can set the Voice wake-up and Sound feedback options.</p> <p> NOTE</p> <ul style="list-style-type: none"> • The microphone for voice recognition is built into the washer's worktop. <ul style="list-style-type: none"> - The best way to use the voice recognition function is to stand within 3 feet (1 meter) of the washer, reduce any background noise, and speak loudly and clearly at a steady pace toward the built-in microphone. • The voice recognition function may not work if you stand more than 3 feet (1 meter) away or if you speak too softly.

Options	Descriptions
Microphone	You can enable or disable the use of the microphone.
App lock	You can set a passcode to lock an app.
Storage	You can check the washer's internal storage space.
Security status of your devices	You can check the security status of all devices logged into your Samsung account.
Language	You can change the system language.
Date and time	You can set the time and date automatically or manually and set the desired time format.
Liquid units	You can select the liquid units.
Accessibility	<p>You can set the Screen reader and Visibility enhancements settings.</p> <ul style="list-style-type: none"> • Screen reader: Enable this feature to receive voice guidance from your washer. <ul style="list-style-type: none"> - Turn on the power, tap  - Accessibility - Screen reader, and tap On to enable the feature. - When the Screen reader feature is enabled, tapping an item once will read it aloud, and tapping it twice will execute the action. You can also navigate the screen by swiping in any direction with two fingers. - Some options in the menu may be unavailable while the Screen reader feature is enabled. <p> NOTE</p> <p>To disable the feature, follow these instructions. (single tap: select / double-tap: execute):</p> <ol style="list-style-type: none"> 1. Select  at the top right of the screen and double-tap to enter the menu. 2. In the  menu, swipe the screen with two fingers to find and select Accessibility, and then double-tap to enter the menu. 3. Select Screen reader, and double-tap to enter the menu. 4. Select Off and double-tap to change the setting. <ul style="list-style-type: none"> • Visibility enhancements: You can change the High contrast and Text size settings to enhance the visibility.
Software update	You can download and install the latest version of the software. Download begins automatically when the washer is connected to Wi-Fi.
Support	You can check the user guide or start the remote support service. <ul style="list-style-type: none"> • Get remote support for all your needs related to your appliance.



Operations

Options	Descriptions
Reset	<p>You can reset network settings or reset all settings.</p> <ul style="list-style-type: none">• Reset network settings : Turn on the power, tap  - General - Reset - Reset network settings - Reset in that order.<ul style="list-style-type: none">- This will reset the Wi-Fi and SmartThings connection settings.• Reset all settings : Turn on the power, tap  - General - Reset - Reset all settings - Reset in that order.<ul style="list-style-type: none">- This will reset all the settings, including network settings and personal data.- Your washer resets to the factory setting.• Restart : Restart the device.
About device	<p>You can check the information of the washer such as Status and Legal information.</p>

Washer

Options	Descriptions
Drum light	This turns on the light inside the drum so you can check the status of the items inside.
Auto dispensers	<p>You can select the dispenser mode and set the detergent type, concentration, and amount setting. The washer automatically dispenses an adequate amount of detergent for the selected cycle.</p> <ul style="list-style-type: none"> • Dispenser mode: You can select the Dispenser mode. The default setting is General and Softener. <ul style="list-style-type: none"> - You can select General and Softener, General and Specialty, or General and General. • Detergent type <ul style="list-style-type: none"> - Dispenser1: You can only select General. - Dispenser2: You can set this dispenser to dispense detergent (General, Specialty) or softener. • Concentration: You can change the concentration level. <ul style="list-style-type: none"> - 1x > 2x > 3x - The default setting is 1x. • Amount: You can select the amount of the detergent to be dispensed during each wash cycle. <ul style="list-style-type: none"> - Low > Medium > High - The default setting is Medium. <p> NOTE</p> <ul style="list-style-type: none"> • You can enable and disable automatic detergent dispensing and set the detergent amount to be dispensed for each cycle. You must put detergent manually if you disable the automatic detergent dispensing. • For the cycles that require the use of special detergent, only the available options are displayed.
Pump clean	<p>You can use this function to clean detergent or softener residue buildup in the pump.</p> <p>Use this function after you empty and clean the dispenser.</p> <ul style="list-style-type: none"> • You can select from Auto dispensers, Flex auto dispenser, or Auto dispensers/Flex auto dispenser. <ul style="list-style-type: none"> - Pour water up to the MAX line in the dispenser, and then tap Start cleaning. <p> NOTE</p> <p>During the pump cleaning process, the drum rotates to drain water. When the pump cleaning process is complete, the water inside the dispenser(s) will drain automatically.</p>

Operations

Options	Descriptions
My cycles	<p>Add or remove cycles to create a personal cycle list.</p> <ul style="list-style-type: none"> You can only edit a cycle to create a personal cycle when the washer is not operating. <p> NOTE</p> <ul style="list-style-type: none"> The Normal and Drum Clean+ cycle cannot be removed from the list of cycles. You can also edit My cycles in the SmartThings app.
AI pattern	<p>This function saves frequently used cycles and settings. When you turn the function on, the washer remembers the cycles you use most and their settings and displays them in frequency order.</p> <ul style="list-style-type: none"> The default setting is On. Set it to Off if you do not want to use this function. When you turn off the function, all the saved data resets.
Auto open door	<p>You can set the washer door to open automatically after the cycle is finished.</p> <ul style="list-style-type: none"> The default setting is Open immediately. You can select from Off, Open 5 minutes later, or Open immediately. <p> NOTE</p> <ul style="list-style-type: none"> Available options for the Auto open door function are active only when the function is on. The options are inactive when the function is off. The Auto open door function does not work when Lock is enabled. The door will not open at the end of the cycle if you have enabled the Stay Connect function in the SmartThings app.
Calibration	<p>You can run calibration again for accurate weight detection.</p> <ul style="list-style-type: none"> Calibration does not start if the door is not closed properly. The drum rotates clockwise and counterclockwise for about 3 minutes.
Self Diagnosis	<p>You can use this function to check for abnormal signs on your washer.</p> <ul style="list-style-type: none"> If the washer detects an error, an information code and solution is displayed on the LCD panel.
Dryer connection	<p>This menu is only available when a dryer is connected to the washer. You can check and manage the connection status.</p>

Delay End

You can set the washer to finish your wash automatically at a later time, choosing a delay of between 5 hours to 24 hours.

1. Select a cycle and change the cycle settings as necessary.
2. Tap **Delay End**  at the bottom of the Cycle screen.
3. Set the desired end time, and then tap **OK**.
 - Status shows in the display and the washer tumbles the drum to sense the weight of the load (if load sensing is preset for the selected cycle). When load sensing is complete, the display shows the remaining time until the end of the wash cycle.
 - The time at which the operation ends may vary depending on the amount and condition of the laundry items.
 - To cancel Delay End, tap **Stop** to restart the washer.



Operations

Special features

Smart Control

You can connect to the SmartThings app and control your washer remotely.

Connecting your washer



1. Download and open the SmartThings app on your smartphone or tablet (Android & iOS).
2. Tap  to turn on the washer.
3. Swipe down from the top of the screen to open the Quick Panel and tap .
4. Tap **General** > **Connections** > **Easy Connection**.
5. Follow the on-screen instructions to add the product to the app.

NOTE

- If your washer fails to connect with the SmartThings app, try again.
- Check your router if you experience any Internet connection problems after connecting your washer with the SmartThings app.
- If the Wi-Fi is off, swipe down from the top of the screen to open the Quick Panel and tap  to turn the Wi-Fi on.
- Close the door before starting the Smart Control function.
- If you use your washer for a while without connecting it to the SmartThings app, a pop-up message about Smart Control will appear regularly for 3 seconds after 20th use.

Stay Connect

Set up the Stay Connect function in your SmartThings app to keep Smart Control turned on at the end of a cycle. Your washer stays connected to the app so you can send additional instructions, whether you are at home or away.

1. If you turn on the Stay Connect function on the SmartThings app, the washer will stay in standby after completing a cycle.
 - The Stay Connect function will remain active for up to 24 hours if the door remains closed.
2. The  and  appears on the LCD screen.
 - The icons may not appear in certain circumstances.
3. You can conveniently control your washer using the SmartThings app.

NOTE

The washer switches to standby when operation is paused even if the machine is not connected to the SmartThings app.

SmartThings

Wi-Fi connection

On your smartphone or tablet, go to **Settings** and turn on the wireless connection and select an AP (Access Point).

- This appliance supports the Wi-Fi 2.4 GHz and 5 GHz protocols.

Download

On an app market (Google Play Store, Apple App Store, Samsung Galaxy Apps), find the SmartThings app by searching for "SmartThings". Download and install the app on your device.

NOTE

The app is subject to change without notice for improved performance.

Log in

You must first log into SmartThings with your Samsung account. To create a new Samsung account, follow the instructions on the app. You don't need a separate app to create your account.

NOTE

If you have a Samsung account, use the account to log in. A registered Samsung smartphone or tablet user automatically logs in.

Operations

To register your appliance to SmartThings

1. Make sure your smartphone or tablet is connected to a wireless network. If not, go to **Settings** and turn on the wireless connection and select an AP (Access Point).
2. Open **SmartThings** on your smartphone or tablet.
3. If a message of "A new device is found.", select **Add**.
4. If no message appears, select **+** and select your appliance in a list of devices available. If your appliance is not listed, select **Device Type > Specific Device Model**, and then add your appliance manually.
5. Register your appliance to the SmartThings app as follows.
 - a. Add your appliance to SmartThings. Make sure your appliance is connected to SmartThings.
 - b. When registration is complete, your appliance appears on your smartphone or tablet.

If you're moving out, we recommend you completely wipe the appliance and do a network reset on it before you leave it behind.

If you're moving in, the easiest way to take control and remove the previous user's access is to add it to SmartThings yourself. But if you don't plan on using SmartThings, a network reset should be performed to protect your privacy. In rental properties, there's a regular change of ownership. To ensure resident privacy, Wi-Fi and/or other connectivity settings should be reset at each change of resident. Please refer to factory reset instructions in this manual.

Maintenance

Keep the washer clean to prevent deteriorated performance and to preserve its life cycle.

WARNING

Certain internal parts are intentionally not grounded and may present a risk of electric shock only during servicing. Service personnel – Do not contact the following parts while the appliance is energized: Control board, heat sink, motor, inlet valve and pump.

Product Care

The Product Care screen offers maintenance tips to keep your washer clean and prolong the product life cycle.

You can check the remaining number of cycles until the next Drum Clean+ duration, and start the Drum Clean+ cycle.

NOTE

If the Drum Clean+ cycle needs to be performed, a guide message will appear on the Home screen. Follow the on-screen instructions to run the Drum Clean+ cycle.

1. On the Home screen tap **Product Care** to move to the Product Care screen.
2. Tap **Clean now** or **Start cleaning** under the desired option to start the care cycle.
 - All the options for the Product Care cycle are set automatically.
 - If the drum requires cleaning, all the necessary options for the Drum Clean+ cycle are set automatically.
3. Tap  to move to the Home screen.

Maintenance

Drum Clean+

Certain usage and environmental conditions may result in some residue build-up or odor in the drum. To prevent this build-up or odor and keep the drum fresh and clean, perform the Drum Clean+ cycle at least once a month or every 40 cycles. Perform the recommended procedure below when using the Drum Clean+ cycle.

1. Tap .
2. On the cycle screen, select **Drum Clean+**.
3. Tap **Clean now**.

CAUTION

If there is chlorine bleach left in the drum for an extended period of time, rust can occur.

NOTE

- The water temperature for Drum Clean+ is defaulted to Extra Hot. This temperature cannot be changed.
- In the case where residue is present in the drum, add liquid chlorine bleach to the MAX level line in the Manual bleach compartment before starting the Drum Clean+ cycle. Do not add the liquid chlorine bleach to the other compartments (This is only the case for Drum Clean+ cycle).
- Do not exceed the max line. Do not use or mix any other detergent or chemicals during the Drum Clean+ cycle. If necessary, run a Rinse+Spin cycle after the Drum Clean+ cycle has completed to help remove any remaining residue.

Drum Clean+ reminder

- After every 40 cycles, the washer displays the "**It's time for Drum Clean+. Press Clean now to clean the drum.**" message for an hour to alert you to run the **Drum Clean+** cycle.
- It is recommended to run the cycle regularly for hygienic purposes.
- You will see the **Drum Clean+** alert message when the washer completes a cycle. If you open the door, the message disappears, and the display shows the **Drum Clean+** cycle setting screen automatically. At this time, the LCD panel displays the recommended drying cycle.
- The reminder will appear on the LCD panel for 5 additional consecutive cycles before turning off. The next reminder will not appear until another 40 cycles have been completed.

Emergency drain

In case of a power failure, drain the water inside the drum before taking out the laundry.

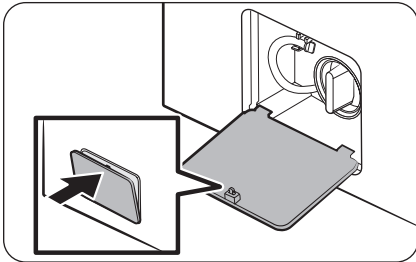

1. Power off and unplug the washer from the electrical outlet.
2. Gently press the top area of the **filter cover** to open.

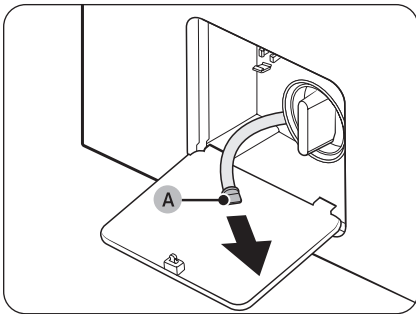

3. Put an empty, spacious container around the cover, and stretch the emergency drain tube to the container while holding the **tube cap (A)**.

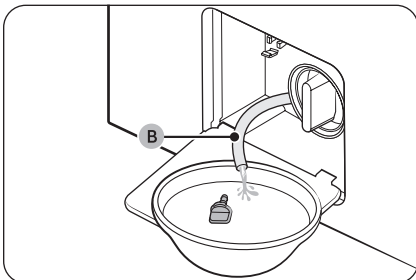

4. Open the tube cap and let water in the **emergency drain tube (B)** flow into the container.
5. When done, close the tube cap, and reinsert the tube. Then, close the filter cover.

 **NOTE**

Use a spacious container because the water in the drum may be more than expected.

Maintenance

Cleaning

Surface of the washer

Use a soft cloth with a nonabrasive household detergent. Do not spray water onto the washer.

Mesh filter

Clean the mesh filter of the water hose once or twice a year.

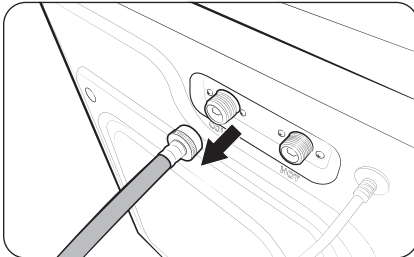

1. Turn off the washer, and unplug the power cord.
2. Close the water tap.
3. Loosen and disconnect the water hose from the back of the washer. Cover the end of each hose with a cloth or towel to prevent water from gushing out.

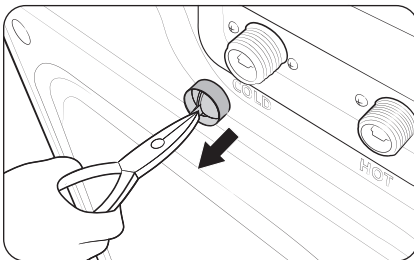

4. Use pliers to pull out the mesh filter from the inlet valve.
5. Submerge the mesh filter deeply in water so that the threaded connector is also submerged.
6. Dry the mesh filter completely in the shade.
7. Reinsert the mesh filter into the inlet valve, and reconnect the water hose to the inlet valve.
8. Open the water tap.

NOTE

- If the mesh filter is clogged, an information code of "4C" appears on the screen.
- Clean the mesh filter of the water hose more frequently if water is provided by an aged water system or well.

Drain filter

It is advisable to clean the drain filter every 2 months to prevent its clogging.

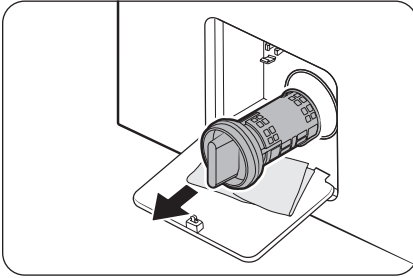

1. Turn off the washer, and unplug the power cord.
2. Drain the remaining water inside the drum. See the **Emergency drain** section.
3. Gently press the top area of the **filter cover** to open.
4. Turn the drain filter knob to the left, and drain off the remaining water.

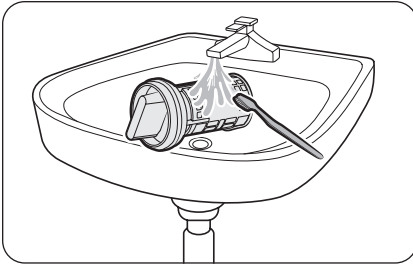

5. Clean the drain filter using soft brushes. While the drain filter is removed, make sure the impeller inside the drain pump is free of debris.
6. Reinsert the drain filter, and turn the filter knob to the right.

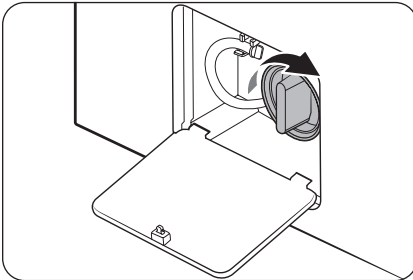

NOTE

Some drain filters feature a safety knob that is designed to prevent accidents by children. To open the safety knob of the drain filter, push in and turn it anticlockwise. The spring mechanism of the safety knob helps open the filter.

NOTE

If the drain filter is clogged, an information code of "5C" appears on the screen.

CAUTION

- Make sure the filter knob is closed properly after cleaning the filter. Otherwise, this may cause a leak.
- Make sure the filter is inserted properly after cleaning it. Otherwise, this may cause an operational failure or a leak.

Maintenance

Detergent drawer

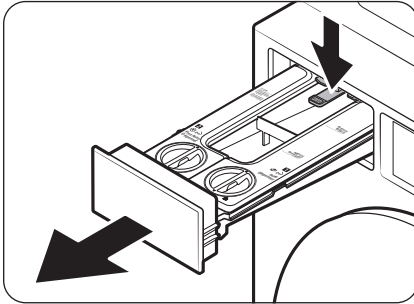

1. While holding down the **release lever** on the inner of the drawer, pull the detergent drawer to remove.

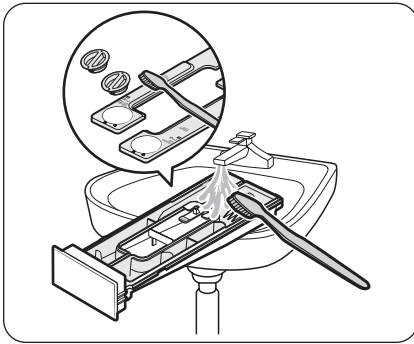

2. Remove the covers of both dispensers using the pull tabs located on the back of the lid, then clean inside the dispensers under warm running water with a soft brush.
3. Clean the drawer components in warm running water using a soft brush.
 - Wipe all components with a dry towel or cloth after cleaning.

NOTE

If the cleaning agent in the dispenser is hardened, open the dispenser, and pour lukewarm water into the dispenser to dissolve the hardened agents. Then, clean inside the dispenser and its rear valve thoroughly.

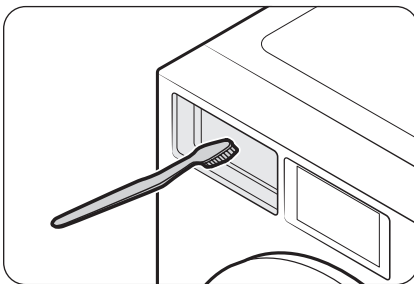

4. Clean the drawer recess using a bottle brush to remove detergent residues and limescale on the drawer recess.

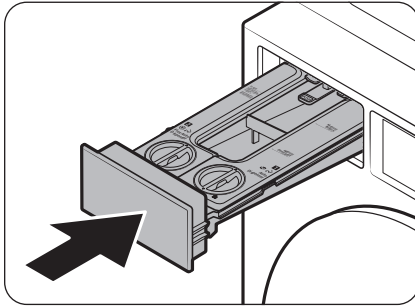

5. Insert the detergent drawer back into the washer.

NOTE

- Make sure the drawer recess is completely dry before inserting the detergent drawer.
- Cover the covers of both dispensers and re-insert them into the drawer.

CAUTION

Do not spray water into the detergent drawer recess. This may result in electric shock or fire.

Door diaphragm

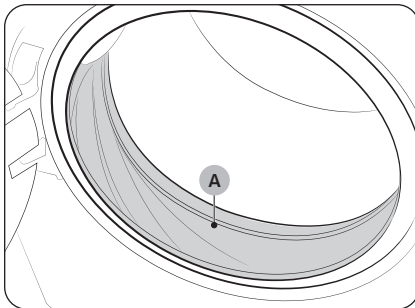

1. Open the door, and then empty the drum.
2. Combine 3/4 cups of liquid chlorine bleach and 1 gallon of warm tap water.
3. Wearing rubber gloves, use a soft, clean cloth dipped in the water and bleach solution to clean the diaphragm.
4. Let stand 5 minutes, and then wipe up and dry well.

CAUTION

Use bleach carefully and be sure to follow the bleach manufacturer's use and care instructions.

Maintenance

Recovery from freezing

The washer may freeze when the temperature in its location drops below 32 °F (0 °C).



1. Turn off the washer, and then unplug the power cord.
2. Pour warm water over the water tap to loosen the water hose.
3. Disconnect the water hose, and then soak it in warm water.
4. Pour warm water into the drum and leave it for about 10 minutes.
5. Reconnect the water hose to the water tap.

NOTE

If the washer still doesn't operate normally, repeat the steps above.

Care for an extended period of non-use

Avoid leaving the washer unused for an extended time. However, if you intend to leave the washer unused for a long period of time, follow the directions below:

1. Tap .
2. On the cycle screen, select **Rinse+Spin**.
3. Empty the drum, and then tap and hold .
4. When the cycle is complete, close the water taps and disconnect the water hoses.
5. Turn off the washer, and then unplug the power cord.
6. Open the door to let air circulate through the drum.

Cleaning the exterior

1. Turn off the water taps after finishing the day's washing.
This will shut off the water supply to your washer and prevent the unlikely possibility of damage from escaping water. Leave the door open to allow the inside of your washer to dry out.
2. Use a soft cloth to wipe up all detergent, bleach, or other spills as they occur. Clean the following as recommended below:
 - Control Panel – Clean with a soft, damp cloth. Do not use abrasive powders or cleaning pads. Do not spray cleaners directly on the panel.
 - Cabinet – Clean with soap and water.

CAUTION

Make sure to turn off the washer and unplug the power cord before cleaning.

Cleaning the interior

Clean the interior of your washer periodically to remove any dirt, soil, odor, mold, mildew, or bacterial residue that may remain in your washer as a result of washing clothes.

CAUTION

Failure to follow these instructions may result in unpleasant conditions, including odors and/or permanent stains on your washer or laundry.

NOTE

Hard water deposits may be removed, if needed. Use a cleaner labeled "Washer safe".

Troubleshooting

If a problem persists, contact a service center. The number of the service center is on the label attached to the product.



Checkpoints

If you encounter a problem with the washer, first check the table below and try these suggestions.

Problem	Action
Does not start.	<ul style="list-style-type: none">• Make sure the washer is plugged in.• Make sure the door is properly closed.• Make sure the water taps are open.• Tap  to start the washer.• Make sure Lock is not activated.• Before the washer starts to fill, it will make a series of clicking noises to check the door lock and will do quick drain.• Check the fuse or reset the circuit breaker.• Check if power is supplied properly.• Low voltage detected.<ul style="list-style-type: none">– Check if the power cord is plugged in.• Make sure laundry is not caught in the door.• Clean the filter.
Water supply is insufficient, or no water is supplied.	<ul style="list-style-type: none">• Fully open the water tap.• Make sure the door is properly closed.• Make sure the water supply hose is not frozen.• Make sure the water supply hose is not kinked or clogged.• Make sure there is sufficient water pressure.• Make sure that the cold water tap and the hot water tap are properly connected.• Clean the mesh filter as it may be clogged.
After a cycle, detergent remains in the detergent drawer.	<ul style="list-style-type: none">• Make sure the washer is running with sufficient water pressure.• Make sure the detergent is added to the center of the detergent drawer.• Make sure the rinse cap is inserted properly.• If using granular detergent, make sure the detergent selector is in the upper position.• Remove the rinse cap and clean the detergent drawer.

Problem	Action
<p>Excessive vibrations or makes noise.</p>	<ul style="list-style-type: none"> • Make sure the washer is installed on a level, solid floor that is not slippery. If the floor is not level, use the leveling feet to adjust the height of the washer. • Make sure the shipping bolts are removed. • Make sure the washer is not in contact with any other object. • Make sure the laundry load is balanced. • The motor can cause noise during normal operation. • Overalls or clothes with metallic decorations can cause noise while being washed. This is normal. • Metal objects such as coins can cause noise. After washing, remove these objects from the drum or filter case. • The spinning process is not performing properly because there is not enough laundry or the load is unbalanced. <ul style="list-style-type: none"> - Add more laundry or redistribute the items, then tap Start to restart the washer. Or, turn off the product and turn it back on after 2-3 minutes, then try again. • Remove any items stuck inside the lint filter.
<p>Does not drain and/or spin.</p>	<ul style="list-style-type: none"> • Make sure the drain hose is not kinked between the unit and drain system. If you encounter a drain problem, call for service. • Make sure the drain filter is not clogged. • Close the door and tap . For your safety, the washer will not tumble or spin unless the door is closed. • Make sure the drain hose is not frozen or clogged. • Make sure the drain hose is connected to a drain system that is not clogged. • If the washer is not supplied with sufficient power, the washer will temporarily not drain or spin. As soon as the washer regains sufficient power, it will operate normally. • Make sure the drain hose is positioned correctly, depending on the connection type. • Clean the drain filter as it may be clogged.

Troubleshooting

Problem	Action
The door does not open.	<ul style="list-style-type: none"> • Tap  to stop the washer. • It may take a few moments for the door lock mechanism to disengage. • The door will not open until 3 minutes after the washer has stopped or the power has been off. • Make sure all the water in the drum is drained. • The door may not open if water remains in the drum. Drain the drum and open the door manually. • Make sure the door lock light is off. The door lock light turns off after the washer has drained. • Power off and restart the unit.
Excessive suds.	<ul style="list-style-type: none"> • Make sure you use the recommended types of detergent as appropriate. • Use high efficiency (HE) detergent to prevent oversudsing. • Reduce the detergent amount for soft water, small loads, or lightly soiled loads. • Non-HE detergent is not recommended.
Cannot add additional detergent.	<ul style="list-style-type: none"> • Make sure the remaining amount of detergent and fabric softener is not over the limit.
Stops.	<ul style="list-style-type: none"> • Plug the power cord into a live electrical outlet. • Check the fuse or reset the circuit breaker. • Close the door, and tap  to start the washer. For your safety, the washer will not tumble or spin unless the door is closed. • Before the washer starts to fill, it will make a series of clicking noises to check the door lock and will do quick drain. • There may be a pause or soak period in the cycle. Wait briefly, and the washer may start. • Make sure the mesh filter of the water supply hose at the water taps is not clogged. Periodically clean the mesh filter. • If the washer is not supplied with sufficient power, the washer will temporarily not drain or spin. As soon as the washer regains sufficient power, it will operate normally.

Problem	Action
Fills with the wrong water temperature.	<ul style="list-style-type: none"> • Fully open both taps. • Make sure the temperature selection is correct. • Make sure the hoses are connected to the correct taps. Flush water lines. • Make sure the water heater is set to supply a minimum of 49 °C hot water at the tap. Also, check the water heater capacity and recovery rate. • Disconnect the hoses and clean the mesh filter. The mesh filter may be clogged. • While the washer fills, the water temperature may change as the automatic temperature control feature checks incoming water temperature. This is normal. • While the washer fills, you may notice just hot and/or just cold water going through the dispenser when cold or warm temperatures are selected. This is a normal function of the automatic temperature control feature as the washer determines the water temperature.
Load is wet at the end of a cycle.	<ul style="list-style-type: none"> • Use the High or Extra High spin speed. • Use high efficiency (HE) detergent to reduce oversudsing. • Load is too small. Small loads (one or two items) may become unbalanced and not spin completely. • Make sure the drain hose is not kinked or clogged.
Leaks water.	<ul style="list-style-type: none"> • Make sure the door is properly closed. • Make sure all hose connections are tight. • Make sure the end of the drain hose is correctly inserted and secured to the drain system. • Avoid overloading. • Use high efficiency (HE) detergent to prevent oversudsing. • Check the drain hose. <ul style="list-style-type: none"> - Make sure the end of the drain hose is not placed on the floor. - Make sure the drain hose is not clogged.
Items still wrinkled after Wrinkle Prevent (Wrinkle Away, Wrinkle Release)	<ul style="list-style-type: none"> • Small loads of 1 to 4 items work best. • Load fewer items. Load similar-type items. • Take out the items immediately after drying is complete.

Troubleshooting

Problem	Action
The clothes have lint on them.	<ul style="list-style-type: none"> Always make sure the lint filter is clean before putting items into the washer. When drying items that generate a large amount of lint, you may need to clean the lint filter in the middle of a cycle. Some fabrics (such as white towels) causes more lint and should be dried separately from fabrics that lint attaches easily (such as black linen pants). Check the inside of the pockets to make sure they are empty before drying.
Has odors.	<ul style="list-style-type: none"> Excessive suds collect in recesses and can cause foul odors. Run cleansing cycles to sanitise periodically. Clean the door seal (diaphragm). Dry the interior of the washer after a cycle has finished.
A message appears on the display to alert that dispenser is open.	<ul style="list-style-type: none"> Check if the detergent drawer is closed properly. <ul style="list-style-type: none"> Open the detergent drawer and close it again. Make sure it's closed properly.
The "Needs refill" message does not disappear after refilling the detergent/softener.	<ul style="list-style-type: none"> After refilling the Dispenser1 and Dispenser 2, close the detergent drawer, and then tap . Then, the washer will start to detect the detergent/softener, and the message will disappear. Depending on the type of detergent/softener, the message may not disappear immediately.
Detergent/softener is not dispensed.	<ul style="list-style-type: none"> Check if the Amount option for Dispenser1 or Dispenser 2 is set to Off. The automatic dispensers do not dispense the detergent if the option is set to Off. Tap Settings, select Dispenser1 or Dispenser 2, and then change the Amount option. The automatic dispensers are disabled in the Delicates, Activewear, or Wool cycles. To dispense detergent in those cycles, tap Settings, select Dispenser1 or Dispenser 2, and then change the Amount option.
Excessive or insufficient amount of detergent/softener is dispensed.	<ul style="list-style-type: none"> Check the Amount option for Dispenser1 or Dispenser 2. Tap Settings, select Dispenser1 or Dispenser 2, and then change the Amount option.
Screen retention occurs while using the LCD screen.	<ul style="list-style-type: none"> When the temperature around the washer is low, screen retention may occur while using the LCD. It will function normally when the temperature rises.

If a problem persists, contact a service center. The number of the service center is on the label attached to the product.

Information codes

If there is any problem, check the information message on the LCD screen and follow the on-screen instructions.

Problem	Code	Action
Check drainage	5C	<ul style="list-style-type: none"> The washer isn't draining properly. Clean the drain filter, then tap Start to restart the washer. Or, turn it off and on again after 2-3 minutes, then try again. <p> NOTE</p> <p>If you perform the Condenser Cleaning function without connecting the water supply hose, you may see the 5C code on the LCD display. In this case, please check the drainage and water supply status.</p>
Check water supply	4C	<ul style="list-style-type: none"> Water isn't being supplied properly. Check the faucets, then tap Start to restart the washer. Or, turn it on and off again after 2-3 minutes, then try again.
Please connect the hot/cold water hose connection correctly	4C2	<ul style="list-style-type: none"> The water is too hot. Some fabrics need to be protected. Check if the water supply hoses are properly connected, then tap Start to restart the washer. Or, turn it off and on again after 2-3 minutes and try again.
Incorrect button state	BC2	<ul style="list-style-type: none"> A button on the washer is still pressed in. Turn off the washer, then turn it on again after 2-3 minutes and try again.
Open the door and evenly distribute the load	UB	<ul style="list-style-type: none"> The spinning process is not performing properly because there is not enough laundry or the load is unbalanced. <ul style="list-style-type: none"> Add more laundry or redistribute the items, then tap Start to restart the washer. Or, turn off the product and turn it back on after 2-3 minutes, then try again.
Waterproof items detected	UB1	<ul style="list-style-type: none"> Your laundry contains waterproof items. Remove those items, then tap Start to restart the washer. Or, turn it off and on again after 2-3 minutes, then try again.
Door is open	DC	<ul style="list-style-type: none"> The door is open. Close it and try again.
Close the washer door and try again	DC6	<ul style="list-style-type: none"> Auto open door isn't working properly. If you turn off the power, the door will open. To use Auto open door, turn off Lock and Smart control in SmartThings.

Troubleshooting

Problem	Code	Action
The door switch lock/ unlock is not working properly.	DC1	<ul style="list-style-type: none">• Turn off the washer, then turn it on again after 2-3 minutes and try again.
		<ul style="list-style-type: none">• The door switch isn't working properly.• Check for foreign substances around the door, then push the door closed and try again.
Check filter is inserted correctly	NC	<ul style="list-style-type: none">• Check if the filter is inserted correctly, then tap Start to restart the washer. Or, turn it off and on again after 2-3 minutes, then try again.





If any information code keeps appearing on the screen, contact a local Samsung service center.

Specifications





Fabric care chart

The following symbols provide garment care direction. The clothing care labels include symbols for drying, bleaching, drying and ironing, or dry cleaning when necessary. The use of symbols ensures consistency among garment manufacturers of domestic and imported items. Follow care label directions to optimize garment life and reduce laundering problems.



Wash cycle

	Normal
	Permanent press/Wrinkle resistant/ Wrinkle control
	Gentle/Delicates
	Hand wash



Water temperature

	Ex Hot
	Hot
	Warm
	Cold



Bleach

	Any bleach (when needed)
	Only non-chlorine (color-safe) bleach (when needed)
	Tumble dry





Normal

	Permanent press/Wrinkle resistant/ Wrinkle control
	Gentle/Delicates



Special instructions

	Line dry/Hang to dry
	Drip dry
	Dry flat

Heat setting







	High
	Medium
	Low
	Any heat
	No heat / Air

Iron dry or steam temperatures





	High
	Medium
	Low

Specifications

Warning symbols for laundering

	Do not wash
	Do not wring
	Do not bleach
	Do not tumble dry
	No steam (added to iron)
	Do not iron

Dry-clean

	Dry-clean
	Do not dry-clean
	Line dry/Hang to dry
	Drip dry
	Dry flat

Protecting the environment

- This appliance is manufactured from recyclable materials. If you decide to dispose of it, please observe local waste disposal regulations. Cut off the power cord so that the appliance cannot be connected to a power source. Remove the lid so that animals and small children cannot get trapped inside the appliance.
- Do not exceed the detergent quantities recommended in the detergent manufacturers' instructions.
- Use stain removal products and bleaches before the wash cycle only when necessary.
- Save water and electricity by only washing full loads (the exact amount depends upon the program used).

Declaration of conformity

This appliance complies with UL2157.

Specification sheet

Type		Front loading washer	
		WF90F53*D*	
Capacity (Cu.ft)		5.3	
Water pressure (psi (kPa))		20-116 (137-800)	
NET weight (lb (kg))		225.0 (102.0)	
Spin revolution		1200 RPM	
Heating rating		900 W	
Power consumption	Washing	120 V	200 W
	Washing and heating		1150 W
	Spin		550 W
	Drain		80 W

NOTE

You can fill the tub with dry, unfolded clothes, but DO NOT OVERLOAD the tub.

LIMITED WARRANTY (U.S.A.)

SAMSUNG WASHER

LIMITED WARRANTY TO ORIGINAL CONSUMER PURCHASER WITH PROOF OF PURCHASE AND/OR PROOF OF DELIVERY

This SAMSUNG brand product, as supplied and distributed by SAMSUNG ELECTRONICS AMERICA, INC. (SAMSUNG) and delivered new, in the original carton to the original consumer purchaser, is warranted by SAMSUNG against manufacturing defects in materials or workmanship for the following limited warranty periods, starting on the date of delivery to the original consumer purchaser:

Parts and labor: One (1) year

Stainless tub part (Part Only) : Three (3) years

Washing DIT (Digital Inverter Motor) motor part (Part Only):

- Ten (10) years

This limited warranty is valid only on products purchased and used in the United States that have been installed, operated, and maintained according to the instructions attached to or furnished with the product. To receive warranty service, the purchaser must contact SAMSUNG at the address or phone number provided below for problem determination and service procedures. Warranty service can only be performed by a SAMSUNG authorized service center. The original dated bill of sale and/or proof of delivery must be presented upon request to SAMSUNG or SAMSUNG's authorized service center to receive warranty service.

SAMSUNG will provide in-home service within the contiguous United States during the warranty period at no charge, subject to availability of SAMSUNG authorized servicers within the customer's geographic area. If in-home service is not available, SAMSUNG may elect, at its option, to provide transportation of the product to and from an authorized service center. If the product is located in an area where service by a SAMSUNG authorized servicer is not available, you may be responsible for a trip charge or required to bring the product to a SAMSUNG authorized service center for service.

To receive in-home service, product must be unobstructed and accessible to the service agent.

During the applicable warranty period, a product will be repaired, replaced, or the purchase price refunded, at the sole option of SAMSUNG. SAMSUNG may use new or reconditioned parts in repairing a product, or replace the product with a new or reconditioned product. Replacement parts and products are warranted for the remaining portion of the original product's warranty or ninety (90) days, whichever is longer. All replaced parts and products are the property of SAMSUNG and you must return them to SAMSUNG.

This limited warranty covers manufacturing defects in materials or workmanship encountered in normal household, noncommercial use of this product and shall not cover the following: damage that occurs in shipment, delivery, installation, and uses for which this product was not intended; damage caused by unauthorized modification or alteration of the product; product where the original factory serial numbers have been removed, defaced, changed in any way, or cannot be readily determined; cosmetic damage including scratches, dents, chips, and other damage to the product's finishes; damage caused by abuse, misuse, pest infestations, accident, fire, floods, or other acts of nature or God; damage caused by use of equipment, utilities, services, parts, supplies, accessories, applications, installations, repairs, external wiring or connectors not supplied or authorized by SAMSUNG; damage caused by incorrect electrical line current, voltage, fluctuations and surges; damage caused by failure to operate and maintain the product according to instructions; in-home instruction on how to use your product; and service to correct installation not in accordance with electrical or plumbing codes or correction of household electrical or plumbing (i.e., house wiring, fuses, or water inlet hoses). The cost of repair or replacement under these excluded circumstances shall be the customer's responsibility.

Visits by an authorized servicer to explain product functions, maintenance or installation are not covered by this limited warranty. Please contact SAMSUNG at the number below for assistance with any of these issues.

EXCLUSION OF IMPLIED WARRANTIES

IMPLIED WARRANTIES, INCLUDING THE IMPLIED WARRANTIES OF MERCHANTABILITY OR FITNESS FOR A PARTICULAR PURPOSE, ARE LIMITED TO ONE YEAR OR THE SHORTEST PERIOD ALLOWED BY LAW.

Some states do not allow limitations on how long an implied warranty lasts, so the above limitations or exclusions may not apply to you. This warranty gives you specific rights, and you may also have other rights, which vary from state to state.

LIMITED WARRANTY (U.S.A.)

LIMITATION OF REMEDIES

YOUR SOLE AND EXCLUSIVE REMEDY IS PRODUCT REPAIR, PRODUCT REPLACEMENT, OR REFUND OF THE PURCHASE PRICE AT SAMSUNG'S OPTION, AS PROVIDED IN THIS LIMITED WARRANTY. SAMSUNG SHALL NOT BE LIABLE FOR SPECIAL, INCIDENTAL OR CONSEQUENTIAL DAMAGES, INCLUDING BUT NOT LIMITED TO TIME AWAY FROM WORK, HOTELS AND/OR RESTAURANT MEALS, REMODELING EXPENSES, LOSS OF REVENUE OR PROFITS, FAILURE TO REALIZE SAVINGS OR OTHER BENEFITS REGARDLESS OF THE LEGAL THEORY ON WHICH THE CLAIM IS BASED, AND EVEN IF SAMSUNG HAS BEEN ADVISED OF THE POSSIBILITY OF SUCH DAMAGES. Some states do not allow exclusion or limitation of incidental or consequential damages, so the above limitations or exclusions may not apply to you. This warranty gives you specific rights, and you may also have other rights, which vary from state to state.

SAMSUNG does not warrant uninterrupted or error-free operation of the product. No warranty or guarantee given by any other person, firm, or corporation with respect to this product shall be binding on SAMSUNG.

To obtain warranty service, please contact SAMSUNG at:

Samsung Electronics America, Inc.

700 Sylvan Avenue,

Englewood Cliffs, NJ 07632

1-800-SAMSUNG (726-7864)

www.samsung.com/support

Warranty (CANADA)

SAMSUNG WASHER

LIMITED WARRANTY TO ORIGINAL PURCHASER

This SAMSUNG brand product, as supplied and distributed by SAMSUNG ELECTRONICS CANADA, INC. (SAMSUNG) and delivered new, in the original carton to the original consumer purchaser, is warranted by SAMSUNG against manufacturing defects in materials and workmanship for a limited warranty period of:

Parts and labor : One (1) year

Washing DIT (Digital Inverter Motor) motor part (Part Only):

- Ten (10) years

This limited warranty begins on the original date of purchase, and is valid only on products purchased and used in the Canada. To receive warranty service, the purchaser must contact SAMSUNG for problem determination and service procedures. Warranty service can only be performed by a SAMSUNG authorized service center. The original dated bill of sale must be presented upon request as proof of purchase to SAMSUNG or SAMSUNG's authorized service center. SAMSUNG will provide in-home service during the warranty period at no charge, subject to availability within the Canada. In-home service is not available in all areas.

To receive in-home service, product must be unobstructed and accessible to the service agent. If service is not available, SAMSUNG may elect to provide transportation of the product to and from an authorized service center.

SAMSUNG will repair, replace, or refund this product at our option and at no charge as stipulated herein, with new or reconditioned parts or products if found to be defective during the limited warranty period specified above. All replaced parts and products become the property of SAMSUNG and must be returned to SAMSUNG. Replacement parts and products assume the remaining original warranty, or ninety (90) days, whichever is longer. This limited warranty covers manufacturing defects in materials and workmanship encountered in normal, noncommercial use of this product and shall not apply to the following: damage that occurs in shipment; delivery and installation; applications and uses for which this product was not intended; altered product or serial numbers; cosmetic damage or exterior finish; accidents, abuse, neglect, fire, water, lightning, or other acts of nature or God; use of products, equipment, systems, utilities, services, parts, supplies, accessories, applications, installations, repairs, external wiring or connectors not supplied or authorized by SAMSUNG that damage this product or result in service problems; incorrect electrical line voltage, fluctuations and surges; customer adjustments and failure to follow operating instructions, maintenance and environmental instructions that are covered and prescribed in the instruction book; product removal and reinstallation; problems caused by pest infestations. This limited warranty does not cover problems resulting from incorrect electric current, voltage or supply, light bulbs, house fuses, house wiring, cost of a service call for instructions, or fixing installation errors. SAMSUNG does not warranty uninterrupted or error-free operation of the product.

EXCEPT AS SET FORTH HEREIN, THERE ARE NO WARRANTIES ON THIS PRODUCT EITHER EXPRESS OR IMPLIED, AND SAMSUNG DISCLAIMS ALL WARRANTIES INCLUDING, BUT NOT LIMITED TO, ANY IMPLIED WARRANTIES OF MERCHANTABILITY, INFRINGEMENT OR FITNESS FOR A PARTICULAR PURPOSE.

Warranty (CANADA)

NO WARRANTY OR GUARANTEE GIVEN BY ANY PERSON, FIRM, OR CORPORATION WITH RESPECT TO THIS PRODUCT SHALL BE BINDING ON SAMSUNG. SAMSUNG SHALL NOT BE LIABLE FOR LOSS OF REVENUE OR PROFITS, FAILURE TO REALIZE SAVINGS OR OTHER BENEFITS, OR ANY OTHER SPECIAL, INCIDENTAL OR CONSEQUENTIAL DAMAGES CAUSED BY THE USE, MISUSE, OR INABILITY TO USE THIS PRODUCT, REGARDLESS OF THE LEGAL THEORY ON WHICH THE CLAIM IS BASED, AND EVEN IF SAMSUNG HAS BEEN ADVISED OF THE POSSIBILITY OF SUCH DAMAGES.

NOR SHALL RECOVERY OF ANY KIND AGAINST SAMSUNG BE GREATER IN AMOUNT THAN THE PURCHASE PRICE OF THE PRODUCT SOLD BY SAMSUNG AND CAUSING THE ALLEGED DAMAGE. WITHOUT LIMITING THE FOREGOING, PURCHASER ASSUMES ALL RISK AND LIABILITY FOR LOSS, DAMAGE, OR INJURY TO PURCHASER AND PURCHASER'S PROPERTY AND TO OTHERS AND THEIR PROPERTY ARISING OUT OF THE USE, MISUSE, OR INABILITY TO USE THIS PRODUCT. THIS LIMITED WARRANTY SHALL NOT EXTEND TO ANYONE OTHER THAN THE ORIGINAL PURCHASER OF THIS PRODUCT, IS NONTRANSFERABLE AND STATES YOUR EXCLUSIVE REMEDY.

Some provinces do not allow limitations on how long an implied warranty lasts, or the exclusion or limitation of incidental or consequential damages, so the above limitations or exclusions may not apply to you.

This warranty gives you specific rights, and you may also have other rights, which vary from province to province.

To obtain warranty service, please contact SAMSUNG at:

Samsung Electronics Canada Inc.
2050 Derry Road West,
Mississauga, Ontario L5N 0B9 Canada
1-800-Samsung (726-7864)
www.samsung.com/support

Visits by a Service Engineer to explain functions, maintenance, or installation are not covered by warranty.

Please contact your Samsung call agent for help with any of these issues.

NOTICE TO QUEBEC CONSUMERS – Warranty of Availability of Replacement Parts, Repair Services, and Maintenance and Repair Information

Replacement Parts

Although Samsung Canada will use reasonable efforts to make replacement parts available to customers (subject to availability and applicable lead times), Samsung Canada **does not guarantee** the availability of replacement parts within the meaning of the warranty of availability set out in sections 39 (paragraph 3), 39.1 and 39.2 of the Quebec Consumer Protection Act.

To purchase replacement parts and tools for self-repair, please visit:

samsung.com/ca/support/buy-certified-parts

Repair Services

Although Samsung Canada offers repair services for Samsung products through Samsung Authorized Service Centers located in most major urban centers (defined as a city in Canada with a population equal or greater than 50,000) across Canada, Samsung Canada **does not guarantee** the availability of any repair services within the meaning of the warranty of availability set out in sections 39 (paragraph 3), 39.1 and 39.2 of the Quebec Consumer Protection Act in all locations, cities, or regions in Quebec.

To find your nearest Samsung Authorized Service Center, please visit:

samsung.com/ca/support/service-center

Information for Maintenance or Repair

Although Samsung Canada provides information on the maintenance and/or repair of goods for select Samsung products (please visit samsung.com/ca/support/self-repair for more information), Samsung Canada **does not guarantee** the availability of information that is necessary to maintain or repair Samsung products within the meaning of the warranty of availability set out in sections 39 (paragraph 3), 39.1 and 39.2 of the Quebec Consumer Protection Act.

DISCLAIMER OF LIABILITY

Samsung is not liable for any damage or defect determined to be caused by repair by a non-authorized service provider, self-repair or non-professional repair of the product. Samsung is not liable for any resulting damage to the product, person, or property, or any injury or other product safety issue caused by or resulting from any repair, or any attempt to repair, any diagnosis, maintenance, or modification performed by any person, including, but not limited to, any of the following: (i) any indirect, incidental, special, or consequential damages (including but not limited to, damage to or loss of personal or commercial property, damage to reputation, loss of use, cost of purchase of replacement goods, etc.); (ii) any loss of data, goodwill, privacy, or profits or loss of business opportunity; and (iii) any inability to use, or reduced functionality of, the product. Any damage or defect to product resulting from a repair, or an attempt to repair, the product by any person (other than a Samsung certified service provider) will not be covered by the warranty. Samsung's liability shall be limited to the greatest extent permitted by law.

Warranty (CANADA)

All text, graphics, user interfaces, visual interfaces, photographs, trademarks, and logos (collectively, "Content"), including but not limited to the design, structure, selection, coordination, "look and feel" and arrangement of such Content, contained in this manual is owned, controlled or licensed by or to Samsung, and is protected by trade dress, copyright, patent and trademark laws, and various other intellectual property rights and unfair competition laws.

No part of this manual or the Content may be copied, reproduced, republished, uploaded, posted, publicly displayed, encoded, translated, transmitted or distributed in any way (including "mirroring") to anyone, any entity, any other computer, server, Web site or other medium for publication or distribution or for any commercial purpose, without Samsung's express prior written consent.

Limitation of Liability. WHILE SAMSUNG MAKES ALL REASONABLE EFFORTS TO ENSURE THAT ALL INFORMATION IN THIS MANUAL IS CORRECT, SAMSUNG DOES NOT ASSUME ANY RESPONSIBILITY FOR THE ACCURACY OR COMPLETENESS OF ANY INFORMATION CONTAINED IN THIS MANUAL. SAMSUNG PROVIDES INFORMATION AND MATERIALS CONTAINED IN THIS MANUAL TO YOU ON AN "AS IS" BASIS WITHOUT WARRANTY OF ANY KIND, EITHER EXPRESS OR IMPLIED. SAMSUNG SPECIFICALLY DISCLAIMS ANY LIABILITY FOR ANY DIRECT, INDIRECT, INCIDENTAL, CONSEQUENTIAL OR SPECIAL DAMAGES ARISING OUT OF OR IN ANY WAY CONNECTED WITH YOUR ACCESS TO OR USE OF THE INFORMATION IN THIS MANUAL, INCLUDING BUT NOT LIMITED TO ANY LOSS OR DAMAGE CAUSED BY YOUR RELIANCE ON INFORMATION OBTAINED THROUGH THIS MANUAL. Some jurisdictions do not allow exclusion of certain warranties or limitations of liability, so the above limitations or exclusions may not apply to you. Samsung's liability in any case shall be limited to the greatest extent permitted by law.

Samsung reserves the right, at its sole discretion, to change, modify, add or remove portions of any part of this manual at any time. It is your responsibility to check the manual periodically for changes. Your use of the manual will mean that you accept and agree to the terms and conditions set out in this manual. If you do not agree to comply with the terms and conditions of this manual, in whole or in part, please stop using this manual immediately.

Memo

Memo

Memo

SAMSUNG



Scan the QR code* or visit
www.samsung.com/spsn
to view our helpful
How-to Videos and Live Shows

*Requires reader to be installed on your smartphone

Scan this with your smartphone

QUESTIONS OR COMMENTS?

COUNTRY	CALL	OR VISIT US ONLINE AT
U.S.A - Consumer Electronics	1-800-SAMSUNG (726-7864)	www.samsung.com/support
CANADA	1-800-Samsung (726-7864)	



DC68-000000-00