

# Washer

# User manual

---

WW25FG5\*\*\*\*\*

---

**SAMSUNG**

# Contents

---

<b>Safety information</b>	<b>4</b>
What you need to know about the safety instructions	4
Important safety symbols	4
Important safety precautions	5
CALIFORNIA PROPOSITION 65 WARNING	6
Critical installation warnings	7
Installation cautions	8
Critical usage warnings	8
Usage cautions	10
Critical cleaning warnings	13
<b>Regulatory notice</b>	<b>14</b>
FCC Notice	14
IC Notice	15
Open Source Announcement	16
<b>Installation</b>	<b>17</b>
Unpacking your washer	17
What's included	18
Installation requirements	20
Step-by-step installation	24
<b>Before you start</b>	<b>30</b>
Initial settings	30
Laundry guidelines	30
Detergent drawer guidelines	32
<b>Operations</b>	<b>36</b>
Control panel	36
Operating a cycle	38
Cycle overview	39
Options	40
Cycle chart	40
Spin Only	43
Special features	44
SmartThings	45

---

<b>Maintenance</b>	<b>47</b>
DRUM CLEAN <sup>+</sup>	47
Emergency drain	48
Cleaning	49
Pump filter	50
Detergent drawer	51
Door diaphragm	52
Care for an extended period of non-use	53
Cleaning the exterior	53
Cleaning the interior	53
<b>Troubleshooting</b>	<b>54</b>
Checkpoints	54
Information codes	58
<b>Specifications</b>	<b>60</b>
Fabric care chart	60
Protecting the environment	61
Declaration of conformity	61
Specification sheet	61

# Safety information

---

Congratulations on your new Samsung washer. This manual contains important information on the installation, use and care of your appliance. Please take some time to read this manual to take full advantage of your washer's many benefits and features.

## What you need to know about the safety instructions

---

Please read this manual thoroughly to ensure that you know how to safely and efficiently operate the extensive features and functions of your new appliance. Please store the manual in a safe location close to the appliance for future reference. Use this appliance only for its intended purpose as described in this instruction manual.

Warnings and Important Safety Instructions in this manual do not cover all possible conditions and situations that may occur. It is your responsibility to use common sense, caution and care when installing, maintaining and operating your washer.

Because the following operating instructions cover various models, the characteristics of your washer may differ slightly from those described in this manual and not all warning signs may be applicable. If you have any questions or concerns, contact your nearest service centre or find help and information online at [www.samsung.com](http://www.samsung.com).

## Important safety symbols

---

What the icons and signs in this user manual mean:

### WARNING

Hazards or unsafe practices that may result in **severe personal injury, death and/or property damage**.

### CAUTION

Hazards or unsafe practices that may result in **personal injury and/or property damage**.

### NOTE

Indicates that a risk of personal injury or material damage exists.

### Read the instructions

**These warning signs are here to prevent injury to yourself and others.**

**Please follow them explicitly.**

**After reading this manual, store it in a safe place for future reference.**

Read all instructions before using the appliance.

As with any equipment that uses electricity and moving parts, potential hazards exist. To safely operate this appliance, familiarize yourself with its operation and exercise care when using it.

# SAVE THESE INSTRUCTIONS

---

## Important safety precautions

---

### **WARNING**

**To reduce the risk of fire, electric shock, or injury to persons when using your appliance, follow basic precautions, including the following:**

1. Read all instructions before using the appliance.
2. Do not wash or dry articles that have been previously cleaned in, washed in, soaked in, or spotted with gasoline, dry-cleaning solvents, other flammable or explosive substances as they give off vapors that could ignite or explode.
3. Do not allow children to play on or in the appliance. Close supervision of children is necessary when the appliance is used near children.
4. Before the appliance is removed from service or discarded, remove the door to the washing or drying compartment.
5. Do not reach into the appliance if the drum is moving.
6. Do not install or store this appliance where it will be exposed to the weather.
7. Do not tamper with controls.
8. Do not repair or replace any part of the appliance or attempt any servicing unless specifically recommended in the user-maintenance instructions or in published userrepair instructions that you understand and have the skills to carry out.

## **SAVE THESE INSTRUCTIONS**

## Safety information

---

9. Do not add gasoline, dry-cleaning solvents, or other flammable or explosive substances to the wash water. These substances give off vapors that could ignite or explode.
10. Under certain conditions, hydrogen gas may be produced in a hot water system that has not been used for 2 weeks or more. **HYDROGEN GAS IS EXPLOSIVE.** If the hot water system has not been used for such a period, before using a washer or combination washer-dryer, turn on all hot water faucets and let the water flow from each for several minutes. This will release any accumulated hydrogen gas. As the gas is flammable, do not smoke or use an open flame during this time.

### CALIFORNIA PROPOSITION 65 WARNING

---

#### **WARNING**

Cancer and Reproductive Harm - [www.P65Warnings.ca.gov](http://www.P65Warnings.ca.gov).

## SAVE THESE INSTRUCTIONS



---

## Critical installation warnings

---

### WARNING

The installation of this appliance must be performed by a qualified technician or service company.

- Failure to do so may result in electric shock, fire, an explosion, problems with the appliance, or injury.

The appliance is heavy, therefore take care when lifting it.

Plug the power cord firmly into a wall socket that meets local electrical specifications. Use the socket for this appliance only, and do not use an extension cord.

- Sharing a wall socket with other appliances using a power strip or extending the power cord may result in electric shock or fire.
- Ensure that the power voltage, frequency, and current are the same as those of the product specifications. Failure to do so may result in electric shock or fire.

Remove all foreign substances such as dust or water from the power plug terminals and contact points using a dry cloth on a regular basis.

- Unplug the power plug and clean it with a dry cloth.
- Failure to do so may result in electric shock or fire.

Plug the power plug into the wall socket so that the cord is running towards the floor.

- If you plug the power plug into the socket in the opposite direction, the electric wires within the cable may be damaged and this may result in electric shock or fire.

Keep all packaging materials out of the reach of children as these may be dangerous.

- If a child places a bag over its head, it may suffocate.

When the appliance, power plug or power cord is damaged, contact your nearest service centre.

This appliance must be properly grounded.

Do not ground the appliance to a gas pipe, plastic water pipe, or telephone line.

- This may result in electric shock, fire, an explosion, or problems with the appliance.
- Never plug the power cord into a socket that is not grounded correctly and make sure that it is in accordance with local and national regulations.

Do not install this appliance near a heater or any inflammable material.

Do not install this appliance in a humid, oily or dusty location, or in a location exposed to direct sunlight or water (rain drops).

Do not install this appliance in a location exposed to low temperatures.

- Frost may cause the tubes to burst.

Do not install this appliance in a location where gas may leak.

- This may result in electric shock or fire.

# SAVE THESE INSTRUCTIONS



# Safety information

---

Do not use an electric transformer.

- This may result in electric shock or fire.

Do not use a damaged power plug, damaged power cord, or loose wall socket.

- This may result in electric shock or fire.

Do not pull or excessively bend the power cord.

Do not twist or tie the power cord.

Do not hook the power cord over a metal object, place a heavy object on the power cord, insert the power cord between objects, or push the power cord into the space behind the appliance.

- This may result in electric shock or fire.

Do not pull the power cord when unplugging the power plug.

- Unplug the power plug by holding the plug.
- Failure to do so may result in electric shock or fire.

This appliance should be positioned so that the power plug, the water supply taps, and the drain pipes are accessible.

## Installation cautions

---

### CAUTION

This appliance should be positioned in such a way that the power plug is easily accessible.

- Failure to do so may result in electric shock or fire due to electric leakage.

Install your appliance on a solid, level floor that can support its weight.

- Failure to do so may result in abnormal vibrations, movement, noise, or problems with the appliance.

## Critical usage warnings

---

### WARNING

If the appliance is flooded, turn off the water & power supplies immediately and contact your nearest service centre.

- Do not touch the power plug with wet hands.
- Failure to do so may result in electric shock.

If the appliance generates a strange noise, a burning smell, or smoke, unplug the power cord immediately and contact your nearest service centre.

- Failure to do so may result in electric shock or fire.

# SAVE THESE INSTRUCTIONS



---

In the event of a gas leak (such as propane gas, LP gas, etc.), ventilate immediately without touching the power plug. Do not touch the appliance or power cord.

- Do not use a ventilating fan.
- A spark may result in an explosion or fire.

Do not let children play in or on the washer. In addition, when disposing of the appliance, remove the washer door lever.

- Children can suffocate to death if trapped inside the product.

Make sure to remove the packaging (sponge, styrofoam) attached to the bottom of the washer before using it.

Do not wash items contaminated with gasoline, kerosene, benzene, paint thinner, alcohol or other inflammable or explosive substances.

- This may result in electric shock, fire, or an explosion.

Do not open the washer door by force while it is operating (high-temperature washing/drying/spinning).

- Water flowing out of the washer may result in burns or cause the floor to be slippery. This may result in injury.
- Opening the door by force may result in damage to the appliance or injury.

Do not touch the power plug with wet hands.

- This may result in electric shock.

Do not turn the appliance off by unplugging the power cord while an operation is in progress.

- Plugging the power cord into the wall socket again may cause a spark and result in electric shock or fire.

Do not let children climb in or onto the appliance.

- This may result in electric shock, burns or injury.

Do not insert your hand or a metal object under the washer while it is operating.

- This may result in injury.

Do not unplug the appliance by pulling the power cord. Always grip the plug firmly and pull it straight out of the outlet.

- Damage to the power cord may cause a short-circuit, fire and/or electric shock.

Do not attempt to repair, disassemble, or modify the appliance yourself.

- Do not use a fuse (such as copper, steel wire, etc.) other than a standard fuse.
- When the appliance needs to be repaired or reinstalled, contact your nearest service centre.
- Failure to do so may result in electric shock, fire, problems with the appliance, or injury.

If the water supply hose comes loose from the water tap and floods the appliance, unplug the power cord.

- Failure to do so may result in electric shock or fire.

## SAVE THESE INSTRUCTIONS



# Safety information

---

Unplug the power cord when the appliance is not being used for long periods of time or during a thunder or lightning storm.

- Failure to do so may result in electric shock or fire.

If any foreign substance enters into the appliance, unplug the power cord and contact your nearest Samsung Customer Service.

- This may result in electric shock or fire.

Do not let children (or pets) play in or on your washer. The washer door does not open easily from the inside and children may be seriously injured if trapped inside.

## Usage cautions

---

### CAUTION

If the washer is contaminated by a foreign substance such as detergent, dirt, food waste, etc., unplug the power plug and clean the washer using a damp, soft cloth.

- Failure to do so may result in discolouration, deformation, damage, or rust.

The front glass may be broken by a strong impact. Take care when using the washer.

- If the glass is broken, it may result in injury.

After a water supply failure or when reconnecting the water supply hose, open the faucet slowly.

Open the faucet slowly after a long period of non-use.

- The air pressure in the water supply hose or the water pipe may damage a product part or result in a water leak.

If a draining error occurs during an operation, check if there is a draining problem.

- If the washer is used when it is flooded because of a draining problem, it may result in electric shock or fire.

Insert the laundry into the washer completely so that the laundry does not get caught in the door.

- If laundry gets caught in the door, it may result in damage to the laundry or the washer, or result in a water leak.

Turn the water supply off when the washer is not being used.

- Ensure that the screws on the water supply hose connector are properly tightened.

Ensure that the rubber seal and front door glass are not contaminated by a foreign substance (e.g. waste, thread, hair, etc.).

- If a foreign substance is caught in the door or the door is not completely closed, it may cause a water leak.

## SAVE THESE INSTRUCTIONS



---

Open the faucet and check if the water supply hose connectors are firmly tightened and that there are no water leaks before using the product.

- If the connectors on the water supply hoses are loose, it may result in a water leak.

The product you have purchased is designed for domestic use only.

Using the appliance for business purposes qualifies as an appliance misuse. In this case, the appliance will not be covered by the standard warranty provided by Samsung and no responsibility can be attributed to Samsung for malfunctions or damages resulting from such misuse.

Do not stand on the appliance or place objects (such as laundry, lighted candles, lighted cigarettes, dishes, chemicals, metal objects, etc.) on the appliance.

- This may result in electric shock, fire, problems with the appliance, or injury.

Do not spray volatile material such as insecticide onto the surface of the appliance.

- As well as being harmful to humans, this may result in electric shock, fire or problems with the appliance.

Do not place objects that generate electromagnetic fields near the washer.

- This may result in injury due to a malfunction.

Water drained during a high-temperature wash or drying cycle is hot. Do not touch the water.

- This may result in burns or injury.

Do not wash, spin, or dry water-proof seats, mats, or clothing (\*) unless your appliance has a special cycle for washing these items.

(\*): Woollen bedding, rain covers, fishing vests, ski pants, sleeping bags, diaper covers, sweat suits, and bicycle, motor cycle and car covers, etc.

- Do not wash thick or hard mats even if the washer mark is on the care label. This may result in injury or damage to the washer, walls, floor, or clothing due to abnormal vibrations.
- Do not wash throw rugs or doormats with rubber backing. The rubber backing may come off and stick to inside the drum, and this may result in malfunction such as a drainage error.

Do not operate the washer when the detergent drawer is removed.

- This may result in electric shock or injury due to a water leak.

Do not touch the insides of the drum during or just after drying as it is hot.

- This may result in burns.

The door glass becomes hot during washing and drying. Therefore, do not touch the door glass.

Also, do not allow children to play around the washer or touch the door glass.

- This may result in burns.

## SAVE THESE INSTRUCTIONS



# Safety information

---

Do not insert your hand into the detergent drawer.

- This may result in injury as your hand may be caught by the detergent input device.
- Do not use the liquid detergent container (on applicable models only) for powdered detergent. Remove the container and put powdered detergent directly into the Main wash compartment.

Do not place any objects (such as shoes, food waste, animals) other than laundry into the washer.

- This may result in damage to the washer, or injury and death in the case of pets due to the abnormal vibrations.

Do not press the buttons using sharp objects such as pins, knives, fingernails, etc.

- This may result in electric shock or injury.

Do not wash laundry contaminated by oils, creams or lotions usually found in skincare shops or massage clinics.

- This may cause the rubber seal to become deformed and result in a water leak.

Do not leave metal objects such as safety pins, hair pins or bleach in the drum for long periods of time.

- This may cause the drum to rust.
- If rust starts appearing on the surface of the drum, apply a (neutral) cleansing agent to the surface and use a sponge to clean it. Never use a metal brush.

Do not use dry cleaning detergent directly and do not wash, rinse, or spin laundry contaminated by dry cleaning detergent.

- This may result in spontaneous combustion or ignition due to the heat from the oxidation of the oil.

Do not use water from water cooling/heating devices.

- This may result in problems with the washer.

Do not use natural hand-washing soap for the washer.

- If it hardens and accumulates inside the washer, it may result in problems with the appliance, discolouration, rust, or bad odours.

Place socks and brassieres in a washing net and wash them with the other laundry.

Do not wash large laundry items such as bedding in the washing net.

- Failure to do so may result in injury due to abnormal vibrations.

Do not use hardened detergent.

- If it accumulates inside the washer, it may result in a water leak.

Make sure that the pockets of all the clothing items to be washed are empty.

- Hard, sharp objects such as coins, safety pins, nails, screws, or stones can cause extensive damage to the appliance.

Do not wash clothing with large buckles, buttons or other heavy metal objects.

## SAVE THESE INSTRUCTIONS



---

Sort the laundry by colour on the basis of its colorfastness and select the recommended cycle, water temperature and additional functions.

- This may result in discolouration or fabric damage.

Take care that children's fingers are not caught in the door when you close it.

- Failure to do so may result in injury.

To prevent odours and mould, leave the door open after a wash cycle to allow the drum to dry.

To prevent limescale build up, leave the detergent drawer open after a wash cycle and dry inside it.

## Critical cleaning warnings

---

### **WARNING**

Do not clean the appliance by spraying water directly onto it.

Do not use a strong acidic cleaning agent.

Do not use benzene, thinner or alcohol to clean the appliance.

- This may result in discolouration, deformation, damage, electric shock or fire.

Before cleaning or performing maintenance, unplug the appliance from the wall socket.

- Failure to do so may result in electric shock or fire.



# SAVE THESE INSTRUCTIONS



# Regulatory notice

---

## FCC Notice

---

### CAUTION

Any changes or modifications not expressly approved by the party responsible for compliance could void the user's authority to operate the equipment.

This device complies with Part 15 of FCC Rules. Operation is Subject to following two conditions:

1. This device may not cause harmful interference, and
2. This device must accept any interference received including interference that cause undesired operation.

For products sold in the US and Canadian markets, only channels 1–11 are available. You cannot select any other channels.

### FCC STATEMENT:

This equipment has been tested and found to comply within the limits for a Class B digital device, pursuant to part 15 of the FCC Rules. These limits are designed to provide reasonable protection against harmful interference in a residential installation.

This equipment generates, uses, and can radiate radio frequency energy and, if not installed and used in accordance with the instructions, may cause harmful interference to radio communications. However, there is no guarantee that interference will not occur in a particular installation. If this equipment does cause harmful interference to radio or television reception, which can be determined by turning the equipment off and on, the user is encouraged to try to correct the interference by one or more of the following measures:

- Reorienting or relocating the receiving antenna.
- Increasing the separation between the equipment and receiver.
- Connecting the equipment to an outlet that is on a different circuit than the radio or TV.
- Consulting the dealer or an experienced radio/TV technician for help.

### FCC RADIATION EXPOSURE STATEMENT:

This equipment complies with FCC radiation exposure limits set forth for an uncontrolled environment. This equipment should be installed and operated so there is at least 8 inches (20 cm) between the radiator and your body. This device and its antenna(s) must not be colocated or operated in conjunction with any other antenna or transmitter.

## SAVE THESE INSTRUCTIONS



---

## IC Notice

---

The term “IC” before the radio certification number only signifies that Industry Canada technical specifications were met. Operation is subject to the following two conditions:

1. This device may not cause interference, and
2. This device must accept any interference, including interference that may cause undesired operation of the device.

This Class B digital apparatus complies with Canadian ICES-003.

Cet appareil numérique de la classe B est conforme à la norme NMB-003 du Canada.

For products sold in the US and Canadian markets, only channels 1–11 are available. You cannot select any other channels.

### IC RADIATION EXPOSURE STATEMENT:

This equipment complies with IC RSS-102 radiation exposure limits set forth for an uncontrolled environment. This equipment should be installed and operated so there is at least 8 inches (20 cm) between the radiator and your body. This device and its antenna(s) must not be colocated or operated in conjunction with any other antenna or transmitter.



# SAVE THESE INSTRUCTIONS



# Regulatory notice

---

## Open Source Announcement

---

The software included in this product contains open source software. You may obtain the complete corresponding source code for a period of three years after the last shipment of this product by contacting our support team via <http://opensource.samsung.com> (Please use the “Inquiry” menu.)

It is also possible to obtain the complete corresponding source code in a physical medium such as a CDROM; a minimal charge will be required.

The following URL [http://opensource.samsung.com/opensource/SMART\\_AT\\_051/seq/0](http://opensource.samsung.com/opensource/SMART_AT_051/seq/0) leads to the open source license information as related to this product. This offer is valid to anyone in receipt of this information.



### NOTE

- When Wi-Fi is activated, the energy consumption increases in comparison to the values specified in the indicative information.
- Hereby, Samsung declares that this radio equipment is in compliance with Directive 2014/53/EU and with the relevant statutory requirements in the UK. The full text of the EU declaration of conformity and the UK declaration of conformity is available at the following internet address: The official Declaration of conformity may be found at <http://www.samsung.com>, go to Support > Support home and enter the model name. RF max transmitter power : 20 dBm at 2.402 GHz – 2.480 GHz.

## SAVE THESE INSTRUCTIONS

# Installation

Follow these instructions carefully to ensure proper installation of the washer and to prevent accidents when doing laundry.

## WARNING

Certain internal parts are intentionally not grounded and may present a risk electric shock only during servicing. Service personnel – Do not contact the following parts while the appliance is energized: Control board, heat sink, motor, inlet valve and pump.

## Unpacking your washer

Unpack your washer and inspect it for shipping damage. Make sure you have received all the items shown on the next page. If your washer was damaged during shipping, or you do not have all of the items, call 1-800-SAMSUNG (1-800-726-7864). To prevent personal injury or strain, wear protective gloves whenever lifting or carrying the unit.

## WARNING

Packing materials can be dangerous to children; Keep all packing material (plastic bags, polystyrene, etc.) well out of children's reach.

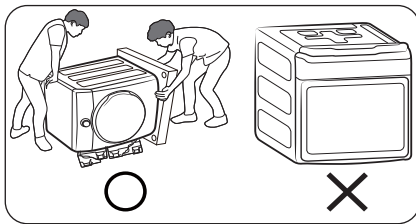

## CAUTION

You must have at least 2 people unpack the washer. To remove the cushion bottom of the packing materials, do not tip the washer over on its front side.

When you lay the washer down to remove the carton base, protect the side of the washer and lay it down carefully. Never lay your washer on its back or front.

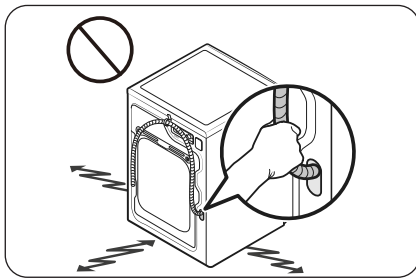

## CAUTION

Do not grab or pull the drain hose to drag and move the product.

# Installation

## What's included

Make sure all the parts are included in the product package. If you have a problem with the washer or the parts, contact a local Samsung customer centre or the retailer.

### NOTE

The appearance of the actual product may differ from the image shown.

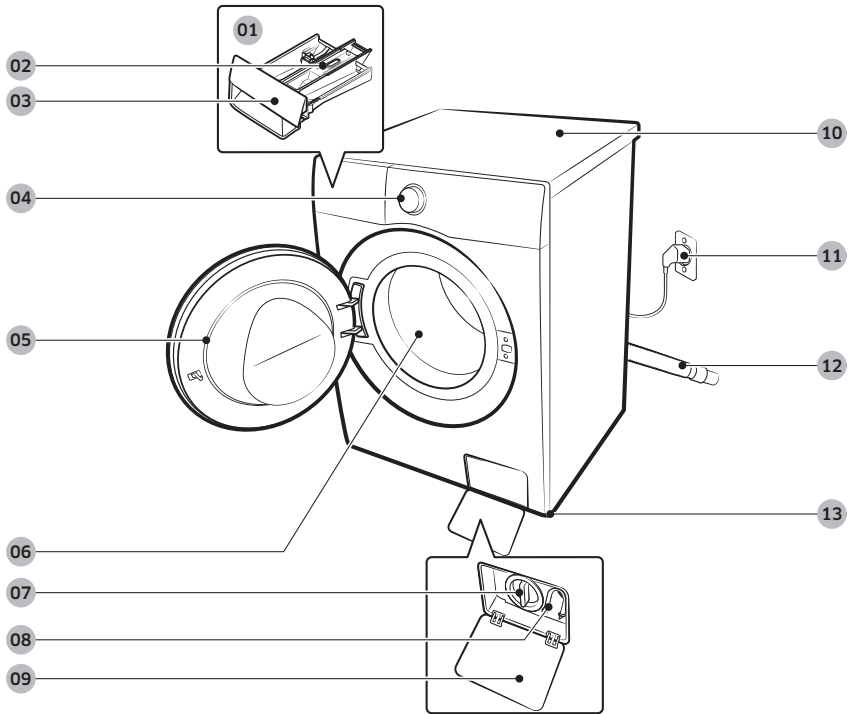

01 Manual dispenser

02 Release lever

03 Detergent drawer

04 Control panel

05 Door

06 Drum

07 Pump filter

08 Emergency drain tube

09 Filter cover

10 Worktop

11 Power plug

12 Drain hose

13 Levelling feet



Spanner



Bolt caps



Cap fixer

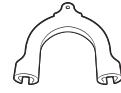

Hose guide



Liquid detergent guide

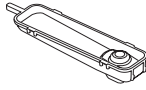

Drawer bleach

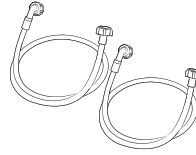

Water hoses



Anti-slip pads

### Tools needed for installation



Philips screwdriver



Level

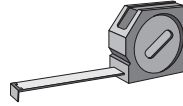

Measuring tape



Adjustable plier

### NOTE

- Spanner: For removing the shipping bolts and levelling the washer.
- Bolt caps: For covering the holes after removing the shipping bolts.  
The provided number of bolt caps (3 to 6) depends on the model.
- Hose guide: For hanging the drain hose in the drainpipe or wash-basin.
- Cold/Hot water hose: For supplying water to the washer. (Hot water hoses is for applicable models only.)
- Liquid detergent guide: Insert it in the detergent compartment to use liquid detergent.
- The appearance of the machine and provided accessories may differ with the model.

### CAUTION

- Do not reuse old water hoses, which may leak or burst, causing flooding and/or property damage.
- Make sure the rubber washers are inserted in each coupling of the water hose.

# Installation

---

## Installation requirements

---

### Electrical supply and grounding

- AC 120 V / 60 Hz / 15 AMP fuse or circuit breaker is required.
- Use an individual branch circuit specific to the washer.

To ensure proper grounding, the washer comes with a power cord featuring a three-prong grounding plug for use in a properly installed and grounded outlet.

Check with a qualified electrician or service person if you are not sure about the grounding.

Do not modify the provided plug. If it does not fit the outlet, call a qualified electrician to install a proper outlet.

### WARNING

- Do NOT use an extension cord.
- Use only the power cord that comes with the washer.
- Do NOT connect the ground wire to plastic plumbing, gas lines, or hot water pipes.
- Improperly connected grounding conductors may cause electric shock.
- To prevent unnecessary risk of fire, electrical shock, or personal injury, all wiring and grounding must be done in accordance with local codes, or in the absence of local codes, in accordance with the National Electrical Code, ANSI/ NFPA No. 70-Latest Revision (for the U.S.) or the Canadian Electrical Code CSA C22.1 – Latest Revisions and local codes and ordinances. It is your responsibility to provide adequate electrical service for your washer.

### Water supply

A proper water pressure for this washer is between 20-116 psi (137-800 kPa). Water pressure less than 20 psi (137 kPa) may cause the water valve not to close completely. Or, it may take longer to fill the drum, causing the washer to turn off. Faucets must be within 4 feet (122 cm) from the rear of the washer so that the provided inlet hoses reach the washer.

To reduce the risk of leaks:

- Make sure faucets are easily accessible.
- Turn off the taps when the washer is not in use.
- Check for any leaks at the water inlet hose fittings on a regular basis.

### CAUTION

Before using the washer for the first time, check all connections at the water valve and taps for any leaks.

## Drain

Samsung recommends a standpipe in height of 18 in (46 cm). The drain hose must be connected through the hose clip to the standpipe, and the standpipe must fully cover the drain hose.

## Flooring

For best performance, the washer must be installed on a solid floor. Wood floors may need to be reinforced to minimize vibration and/or unbalanced loads. Carpeting and soft tile surfaces are not a good resistance to vibrations and may cause the washer to move slightly during the spin cycle.

### CAUTION

Do NOT install the washer on a platform or a poorly supported structure.

## Water temperature

Do not install the washer in areas where water may freeze as the washer always retains some water in its water valves, pumps, and/or hoses. Frozen water left in the connection parts may cause damage to belts, the pump, and other components of the washer.

## Dimensions

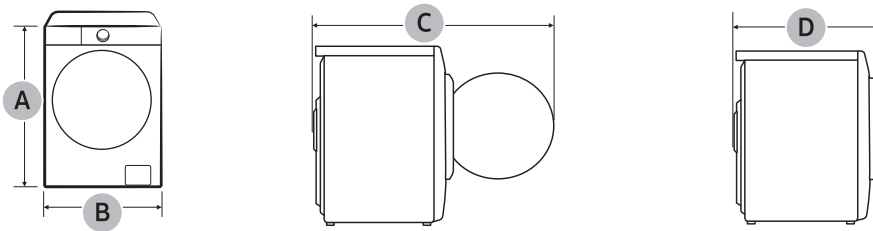

A. Overall height	33.5 in. (850 mm)
B. Width	23.6 in. (600 mm)
C. Depth with door open	42.9 in. (1090 mm)
D. Depth	25.4 in. (645 mm)

# Installation

## Clearance requirement

This clearance requirement is applicable for washers only.

### NOTE

- For dryer's clearance requirement, see the dryer's user manual.
- If the washer and dryer have different clearance requirements, use the one with the larger value.

## Alcove or closet installations

Minimum clearance for stable operation:

Sides	Top	Rear	Front
1 in. (25 mm)	1 in. (25 mm)	2 in. (50 mm)	1 in. (25 mm)

If both the washer and a dryer are installed in the same location, the front of the alcove or closet must have two unobstructed air openings for a combined minimum total area of 72 in<sup>2</sup> (465 cm<sup>2</sup>).

## Undercounter installation

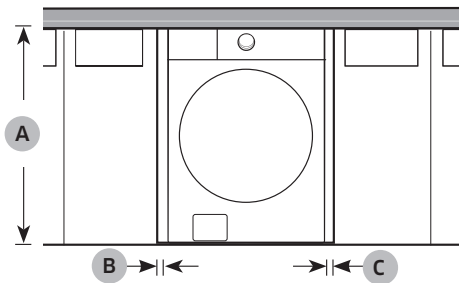

This clearance requirement is applicable for washer and dryer pair installation.

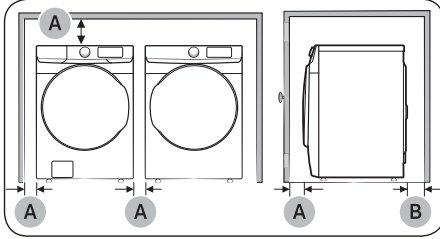

Side by side installation

A	1 in. (25 mm)	
B	2 in. (50 mm) * This clearance requirement only applies to the washer. For dryer's clearance requirement, see the dryer's user manual.	
C	DV25FG**B0**	3 in. (76 mm)
	DV25FG**BV**	4 in. (101 mm)
D	6 in. (152 mm)	
E	67 in. (1702 mm)	

**NOTE**

If you install a new dryer next to the washer you have been using, the dryer may stick out at front more than the washer.

**WARNING**

- Samsung's washers and dryers can be stacked to maximize usable space.
- The dryer feet need to be removed to stack the washer and dryer. You can purchase an optional stacking kit from your Samsung retailer.

**Stacked installation (Model: SKK-DF)**

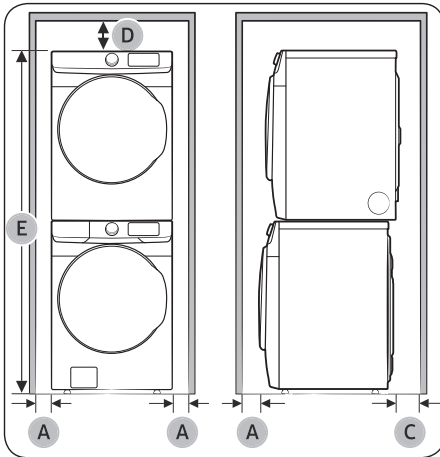

Stacked installation

# Installation

## Step-by-step installation

### STEP 1 Select a location

Location requirements:

- A solid, level surface without carpeting or flooring that may obstruct ventilation
- No direct sunlight
- Adequate room for ventilation and wiring
- Ambient temperature always higher than the freezing point (32 °F / 0 °C)
- Away from heat sources

### STEP 2 Remove the shipping bolts

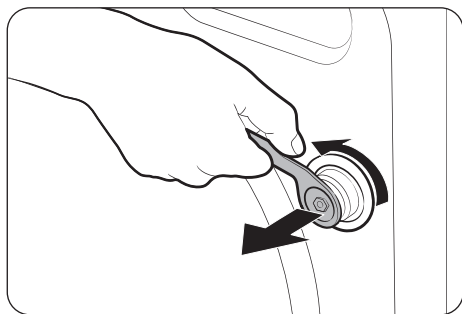

Unpack the product package and remove all shipping bolts.

1. Loosen all shipping bolts on the rear of the machine using the spanner.

#### NOTE

Use the enclosed end of the supplied wrench to remove the shipping bolts.

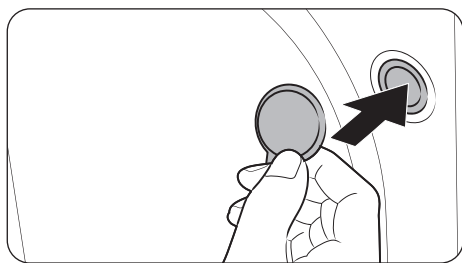

2. Fill the holes with the supplied plastic bolt caps. Keep the shipping bolts for future use.

#### WARNING

- The shipping bolts secure the tub during product transportation and reduce the chance of suspension damage. Remove the shipping bolts before using the product and only reinsert them if you need to move the product.
- Packaging materials can be dangerous to children. Dispose all packaging material (plastic bags, polystyrene, etc.) out of children's reach.

---

### STEP 3 Adjust the levelling feet

---

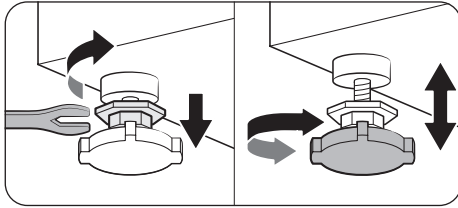

1. Gently slide the washer into position. Excessive force may damage the levelling feet.
2. Level the washer by manually adjusting the levelling feet.

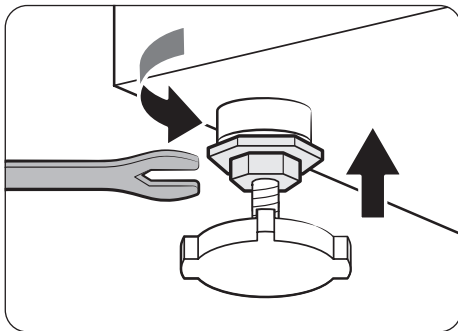

3. When levelling is complete, tighten the nuts using the spanner.

#### CAUTION

Make sure all the levelling feet are seating on the floor surface to avoid the washer from moving or generating noise due to vibration. Then, check if the washer is rocking. If the washer is not rocking, tighten the nuts.

# Installation

## STEP 4 Connect the water hose

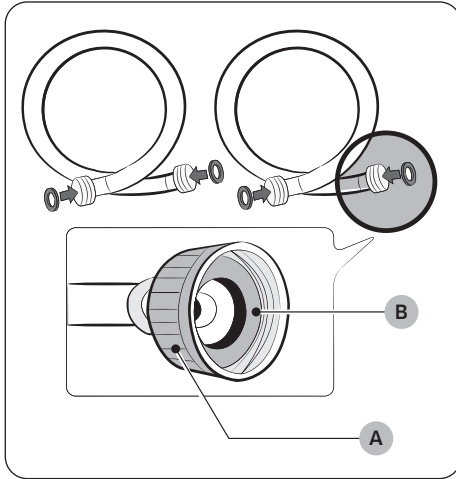

### ⚠ CAUTION

- Make sure you use a new water hose, and there are **rubber gaskets (B)** inside the **couplings (A)** at either end of the water hose. A water hose without the gasket may cause a water leak.
- If there is a water leak, stop using the washer and contact a local Samsung service center. This may cause electric shock.
- Do not stretch the water hose by force. If the hose is too short, replace the hose with a longer, high-pressure hose.
- To prevent leaks, make sure both water hoses are not bent or kinked. A water leak may cause electric shock.

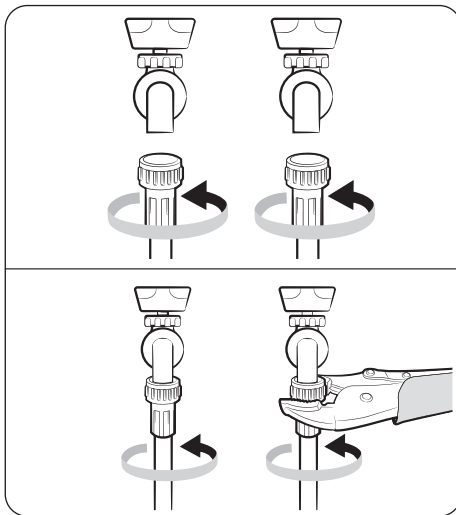

1. Attach the water hoses to the hot and cold water taps, and then hand tighten the water hose fittings until they are tight. Then, use pliers to tighten the fittings by an additional two-thirds of a turn. To avoid damaging the fittings, do not overtighten them.
2. Pull the water hoses to check if they are firmly connected.

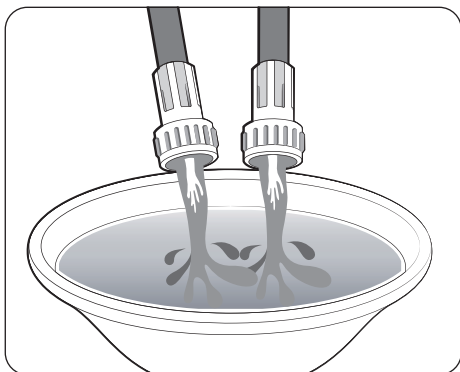

- Put the other ends of the hoses into a bucket and open the taps for 10-15 seconds to remove impurities. When done, close the taps.

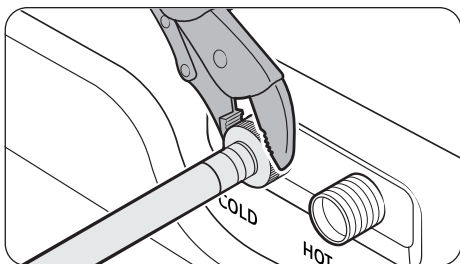

- Attach the water hoses to the hot and cold water inlets on the back of the washer, and then hand tighten the water hose fittings until they are tight. Then, use pliers to tighten the fittings by an additional two-thirds of a turn.

 **NOTE**

If you do not want to use the hot water supply hose, attach the water intake cap to the hot water supply intake. When you do a wash, press **Temp.** to select Cold.

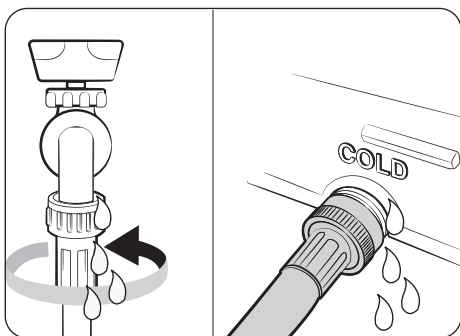

- Open the water taps, and check for leaks.

# Installation

## STEP 5 Connect the drain hose

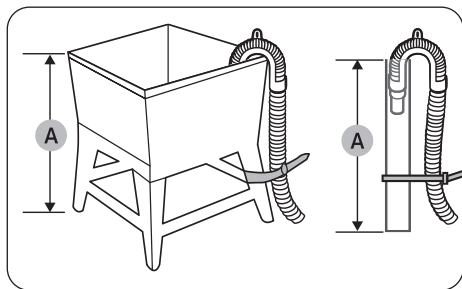

### To a Laundry Tub or Drain Pipe

1. Check the **height (A)** of your drain system and make sure the minimum and maximum heights shown below are met.

Minimum	18 in. (46 cm)
Maximum	96 in. (245 cm)

### NOTE

- Make sure to measure the height from the floor where the washer is placed.
  - Draining efficiency may be reduced if the drain system is at the maximum height.
  - To prevent the washer from siphoning water, do not use a drain system below the minimum height.
2. Attach the drain hose to the **plastic hose guide (B)**.

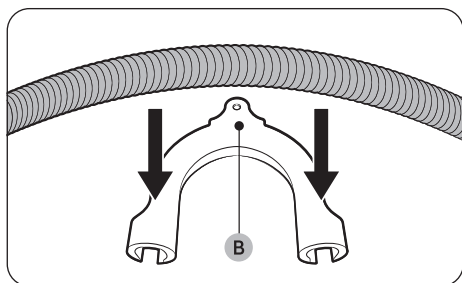

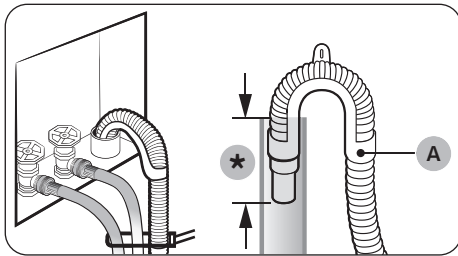

(\*): Min. 6 in. (152 mm), Max. 8 in. (203 mm)

3. Route the drain hose to the drain system.

**⚠ CAUTION**

- If using a standpipe, make sure the standpipe and drain hose connection is not airtight.
  - If using a standpipe, make sure the drain hose is inserted at least 6 in. (152 mm) but no more than 8 in. (203 mm) into the standpipe.
4. Secure the drain hose with cable ties.

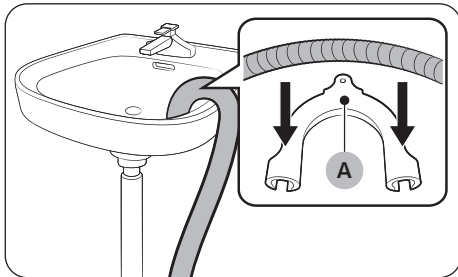

**Over the edge of a wash basin**

The drain hose must be placed no lower than 24 in. (60 cm) and no higher than 35 in. (90 cm) from the floor. To keep the spout of the drain hose bent, use the supplied plastic **hose guide (A)**. Secure the guide to the wall using a hook to ensure stable drainage.

**STEP 6 Power on**

Plug the power cord into a wall socket that is correctly rated, grounded, and protected by a fuse or circuit breaker. Then, tap  to turn on the washer.

# Before you start

---

## Initial settings

---

### Run Calibration (recommended)

Calibration ensures accurate weight detection by the washer. Make sure the drum is empty before running Calibration.

1. Power off, and then power on the washer.
2. Hold down **Temp.** and **Delay End** simultaneously for 3 seconds to enter Calibration mode. The "CB" message appears.
3. Press **▷|| Start/Pause** to run the Calibration cycle.
4. The drum will rotate clockwise and counter-clockwise for about 3 minutes.
5. When the cycle is complete, "0" appears on the display and the washer will turn off automatically.
6. The washer is now ready for use.

## Laundry guidelines

---

### STEP 1 Sort

---

Sort the laundry according to these criteria:

- Care Label: Sort the laundry into cottons, mixed fibres, synthetics, silks, wools, and rayon.
- colour: Separate whites from colours.
- Size: Mixing different sized items together in the drum improves the washing performance.
- Sensitivity: Wash delicate items separately using an Easy Iron option for pure, new woollen items, curtains, and silk items. Check the labels on the items.



#### NOTE

Make sure to check the care label on the clothing, and sort them accordingly before starting the wash.

### STEP 2 Empty pockets

---

**Empty all the pockets of your laundry items**

- Metal objects such as coins, pins, and buckles on clothing may damage other laundry items as well as the drum.

**Turn clothing with buttons and embroideries inside out**

- If trousers or jacket zippers are open while washing, the drum may be damaged. Zippers should be closed and fixed with a string.
- Clothing with long strings may become entangled with other clothes. Make sure to tie the strings before starting the wash.



---

### STEP 3 Use a laundry net

---

- Brassieres (machine washable) must be placed in a laundry net. Metal parts of the brassieres may break through and tear other laundry items.
- Small, light clothing such as socks, gloves, stockings, and handkerchiefs may become caught around the door. Place them inside a fine laundry net.
- Do not wash the laundry net by itself without other laundry. This may cause abnormal vibrations that could move the washer and result in injury.

### STEP 4 Prewash (if necessary)

---

Select the Prewash option for the selected cycle if the laundry is heavily soiled.  
Do not use the Prewash option when detergent is manually added into the drum.

### STEP 5 Determine the load capacity

---

Do not overload the washer. Overloading may cause the washer to not wash properly.



#### NOTE

When washing bedding or bedding covers, the wash time may be lengthened or the spin efficiency may be reduced.

Don't use blankets with too much volume.

For bedding or bedding covers, the recommended maximum spin level is "2 or 3", and the load capacity is 4 lb (2.0 kg) or less.



#### CAUTION

- Unbalanced laundry may reduce the spinning performance.
- Make sure the laundry is fully inserted in the drum and not caught in the door.
- Do not slam the door. Close the door gently. Otherwise, the door may not be closed properly.

### STEP 6 Add the correct detergent type

---

The type of detergent you use - general purpose, specifically for woolens, etc. - depends on the type of fabric (cotton, synthetic, delicate items, wool), color, wash temperature, and degree of soiling. Regardless of the specific type of detergent you use, always use "low suds" HE laundry detergent which is designed for automatic washers.



#### NOTE

- Follow the detergent manufacturer's recommendations based on the weight of the laundry, the degree of soiling, and the hardness of the water in your local area. If you are not sure about the water hardness, contact your local water authority.
- Do not use detergent that tends to harden or solidify. This detergent may remain after the rinse cycle, blocking the drain outlet.



#### CAUTION

When washing wool using the WOOL/DELICATES cycle, use only a neutral liquid detergent. Powdered detergent used with the WOOL/DELICATES cycle can remain on the laundry and discolor it.



# Before you start

## Use HE detergent only



For the best cleaning results, use a high efficiency detergent such as Tide HE, Wisk HE, Cheer HE or Gain HE\*. High efficiency detergents contain suds suppressors that reduce or eliminate suds. When fewer suds are produced, the load tumbles more efficiently and cleaning is maximized. (\* Brand names are trademarks of their respective manufacturers.)

### WARNING

For best results, use HE detergents only. Do not use non-HE detergent, organic detergent, natural detergent or HE detergents with natural ingredients (such as vinegar, baking soda).

## Detergent drawer guidelines

The manual dispenser models provide a three-compartment dispenser: the left compartment for the main wash, the centre for fabric softeners, and the right for the liquid chlorine bleach.

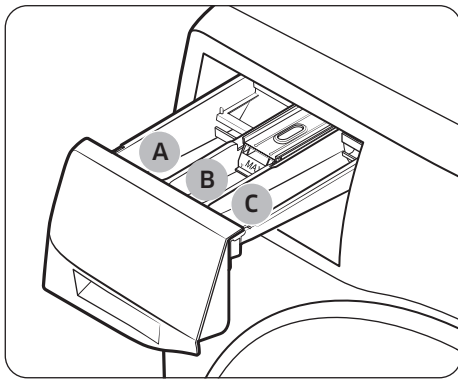

- A. Main-wash compartment:** Apply main-wash detergent, water softener, soaking detergent, color-safe, and/or stain removers.
- B. Softener compartment:** Apply fabric softener. Do not exceed the max line .
- C. Bleach compartment:** Apply liquid chlorine bleach. Do not exceed the max line .

### WARNING

- Do not open the detergent drawer while the washer is operating.
- Do not put a tablet or capsule type detergents into the detergent drawer. Put them directly into the drum.
- Do not use Ball type of detergent.
- To prevent the compartment from clogging, concentrated or highly-enriched agents (fabric softener or detergent) must be diluted with water before being applied.
- Be careful not to spill fabric softener on the worktop or the control panel.

## To add washing agents to the detergent drawer

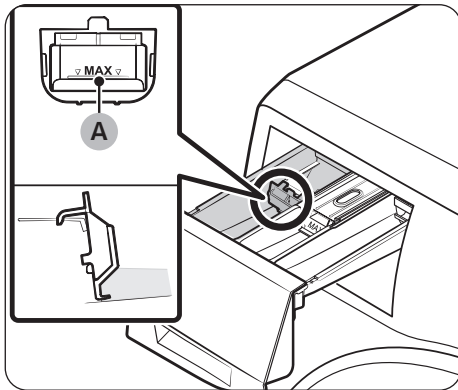

1. Slide open the detergent drawer.
2. First insert the provided liquid container in the **main-wash compartment**.
3. Add liquid laundry detergent to the container below the marked **max line (A)**.

### ⚠ CAUTION

- Make sure the liquid detergent container is inserted in the main wash compartment.
- Do not exceed the marked **max line (A)**.

### 📄 NOTE

- Do not add powdered laundry detergent or other powdered laundry agents to the liquid laundry container.
- Turn up the liquid container if using powder detergent. To use powdered detergent, see page <OV> .

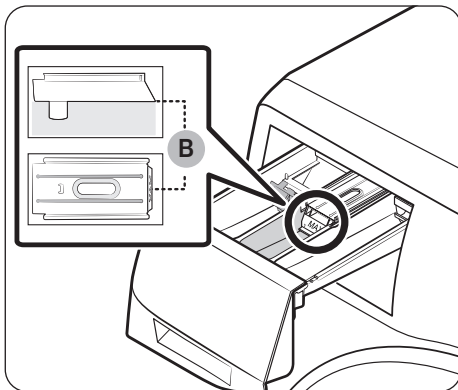

4. Add fabric softener to the **softener compartment**. Do not exceed the **max line (B)**.

### ⚠ WARNING

- Powdered fabric softener is not recommended. Use liquid fabric softener only.
  - Concentrated fabric softener must be diluted with water before being added.
  - Do not add main-wash detergent to the **softener compartment**.
5. Close the detergent drawer.

# Before you start

## To use powdered detergent

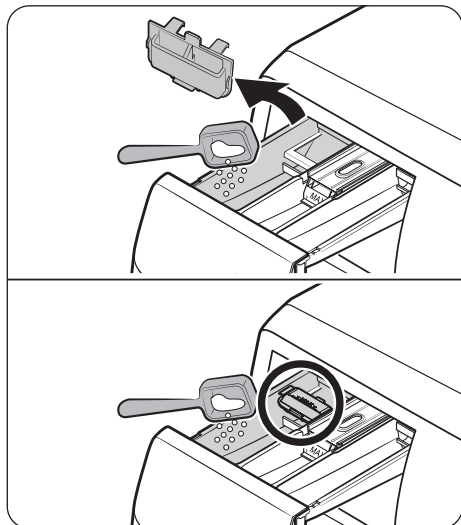

First, remove or turn up the provided liquid detergent container from the **main-wash compartment**. Then, add powdered detergent to the **main-wash compartment** according to the detergent manufacturer's instructions.

### ⚠ CAUTION

Do not add powdered detergent to the liquid detergent container.

## To use the bleach compartment

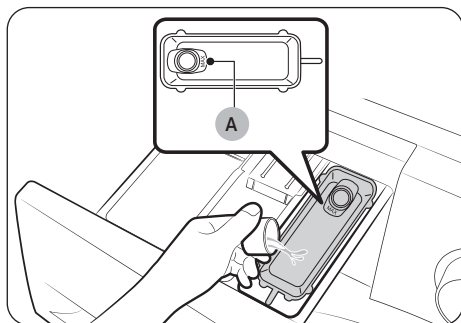

First insert the provided **drawer bleach** in the **bleach compartment**.

Apply only liquid chlorine bleach to the **drawer bleach**. Do not exceed the **max line (A)**.

### ⚠ CAUTION

Do not apply undiluted liquid chlorine bleach directly onto the load or into the drum. It is a powerful chemical and can cause fabric damage, such as weakening of the fibers or color loss, if not used properly.

---

## To use oxygen boosters or color-safe bleach

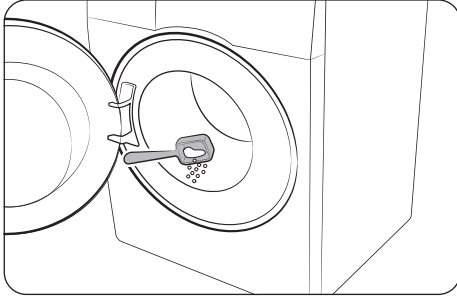

Oxygen boosters or color-safe bleach can increase washing performance.

Make sure to add the oxygen booster or color-safe bleach after putting the laundry into the drum.

 **NOTE**

To use both powder detergent and powder oxygen booster or powder color-safe bleach, it is more effective to put them together into the drum before loading the laundry.

# Operations

## ⚠ WARNING

To reduce the risk of fire, electric shock, or injury to persons, read the IMPORTANT SAFETY INSTRUCTIONS before operating this washer.

## Control panel

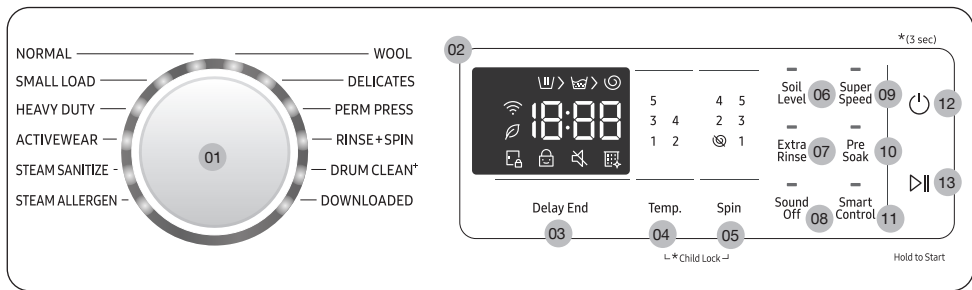

<b>01</b> Cycle Selector	Turn the dial to select a cycle.
<b>02</b> Display	The display shows current cycle information and estimated time remaining, or an information code when a problem occurs.
<b>03</b> Delay End	<p>Delay End lets you set the end time of the current cycle. Based on your settings, the start time of the cycle will be determined by the machine's internal logic. For example, this setting is useful for programming your machine to finish a wash at the time you normally return home from work.</p> <ul style="list-style-type: none"> <li>Press to choose a preset unit of hours.</li> </ul>
<b>04</b> Temp.	<p>Tap to change the water temperature for the selected cycle.</p> <ul style="list-style-type: none"> <li>The indicator above the button indicates the default or selected setting.</li> </ul>
<b>05</b> Spin	<p>Tap to change the spin speed for the selected cycle.</p> <ul style="list-style-type: none"> <li>The indicator above the button indicates the default or selected setting.</li> <li><b>No Spin</b> (🚫): The drum does not spin after the final drain process. <ul style="list-style-type: none"> <li>To use the No Spin option, press <b>Spin</b> repeatedly until the option indicator (🚫) turns on.</li> </ul> </li> <li><b>No Drain</b> (No lamp turns on): The final rinse process is suspended so that the laundry remains in the water. To unload the laundry, run a drain or spin process.</li> </ul>
<b>06</b> Soil Level	Tap to change the soil level for the current cycle.
<b>07</b> Extra Rinse	Press this button to add an additional rinse at the end of the cycle to remove laundry additives more thoroughly.

<b>08</b> Sound Off	<p>Press this button to turn on or off the sound from the washer. Please note that this setting does not affect the sound that notifies information codes.</p> <ul style="list-style-type: none"> <li>When the sound is muted, the indicator  turns on.</li> </ul>
<b>09</b> Super Speed	<p>Press this button if you need to shorten the washing time, the shortened time may differ depending on the Cycles/Load/Option.</p> <ul style="list-style-type: none"> <li>Super Speed is only available for the following wash cycles: Heavy Duty, Steam Allergen.</li> </ul>
<b>10</b> Pre Soak	<p>Press to activate/deactivate the Pre Soak function. This function helps remove a wide variety of stubborn stains.</p> <ul style="list-style-type: none"> <li>Pre Soak is only available for the following wash cycles: Perm Press, Normal, Heavy Duty, Activewear, Steam Sanitize and Steam Allergen.</li> </ul>
<b>11</b> Smart Control	<p>Press to activate or deactivate the Smart Control function. Tap and hold to enter pairing mode to connect to the SmartThings app.</p> <ul style="list-style-type: none"> <li>When the Smart Control function is activated, you can control your washer remotely using the SmartThings app on your smartphone or tablet (Android or iOS).</li> </ul>
<b>12</b> Power	Press to turn on/off the washer.
<b>13</b> Start/Pause	Press to start or stop operation.

# Operations

## Operating a cycle

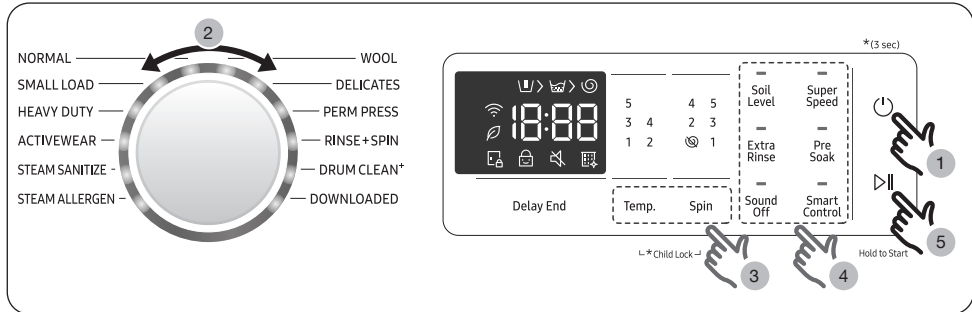

1. Press **Power** to turn on the washer.
2. Turn the **Cycle Selector** to select a cycle.
3. Change the cycle settings (**Temp.**, and **Spin**) as necessary.
4. Select desired options as necessary.
5. Press **Start/Pause**.

### To change the cycle during operation

1. Press **Start/Pause** to stop operation.
2. Select a different cycle.
3. Press **Start/Pause** again to start the new cycle.

### Add Garments

To add laundry after the wash starts, use **Start/Pause**.

1. Tap and hold **Start/Pause** to stop the wash cycle.
2. Open the door and add the laundry into the drum.
3. Close the door, and then tap and hold **Start/Pause** again to resume the wash cycle.

### **WARNING**





Do not place anything on top of your washer while it is running.

## Cycle overview

Cycle	Description
<b>WOOL</b>	<ul style="list-style-type: none"> <li>• Specific for machine-washable wool.</li> <li>• The Wool cycle features fine pulsating and soaking to protect the wool fibres from shrinkage/distortion.</li> <li>• A neutral detergent is recommended.</li> </ul>
<b>DELICATES</b>	<ul style="list-style-type: none"> <li>• For sheer fabrics, bras, lingerie (silk), and other handwash-only fabrics.</li> <li>• For best performance, use liquid detergent.</li> </ul>
<b>PERM PRESS</b>	<ul style="list-style-type: none"> <li>• For wash-and-wear, synthetic fabrics, and lightly to normally soiled items.</li> </ul>
<b>RINSE+SPIN</b>	<ul style="list-style-type: none"> <li>• Featuring an additional rinse process after applying fabric softener to the laundry.</li> </ul>
<b>DRUM CLEAN+</b>	<ul style="list-style-type: none"> <li>• Cleans the drum by removing dirt and bacteria from it.</li> <li>• Cleans the rubber door gasket by removing dirt from the gasket.</li> <li>• Perform once every 40 washes with no detergent or bleach applied. Notification message appears after every 40 washes.</li> <li>• Make sure the drum is empty.</li> <li>• Do not use any cleaning agents for cleaning the drum.</li> </ul>
<b>DOWNLOADED</b>	<ul style="list-style-type: none"> <li>• Select to choose from more cycles available on the SmartThings app on your smartphone.</li> </ul>
<b>NORMAL</b>	<ul style="list-style-type: none"> <li>• For cottons, bed linens, table linens, underwear, towels, or shirts. The washing time and the rinse count are automatically adjusted according to the load.</li> </ul>
<b>SMALL LOAD</b>	<ul style="list-style-type: none"> <li>• For lightly soiled items that you want to finish washing quickly.</li> <li>• For best performance, recommended load is 4 lb (2.0 kg) or lower.</li> </ul>
<b>HEAVY DUTY</b>	<ul style="list-style-type: none"> <li>• For sturdy, colorfast fabrics and heavily soiled items.</li> </ul>
<b>ACTIVEWEAR</b>	<ul style="list-style-type: none"> <li>• For exercise wear such as sports jerseys, training pants, shirts/tops and other performance clothing. This cycle provides effective soil removal with controlled drum rotation for special fabric care.</li> </ul>
<b>STEAM SANITIZE</b>	<ul style="list-style-type: none"> <li>• For colourfast fabrics and heavily soiled laundry, this cycle heats the supplied water over 140 °F (60 °C) to clean deeply.</li> <li>• If you stop running the cycle while the washer is heating the water, the door remains locked for your safety.</li> </ul>
<b>STEAM ALLERGEN</b>	<ul style="list-style-type: none"> <li>• This course is applied to remove dust mites, pet dander or other allergic substances of the fabric.</li> </ul>

# Operations

## Options

Option	Description
 <b>Wi-Fi</b>	<ul style="list-style-type: none"> <li>This icon indicates that the washing machine is connected to Wi-Fi.</li> </ul>
 <b>AI Energy Mode</b>	<ul style="list-style-type: none"> <li>This icon indicates that AI Energy Mode is on.</li> </ul>
 <b>Door Lock</b>	<ul style="list-style-type: none"> <li>This icon indicates the door is locked and cannot be opened.</li> <li>The door locks automatically during a cycle and this indicator turns on.</li> <li>You can open the door when this icon disappears.</li> </ul>
 <b>Child Lock</b>	<ul style="list-style-type: none"> <li>This icon indicates that Child Lock is on.</li> <li>For more information on Child Lock, see page 42.</li> </ul>
 <b>DRUM CLEAN+ reminder</b>	<ul style="list-style-type: none"> <li>This icon indicates that you should clean the drum using the DRUM CLEAN+ cycle.</li> <li>After every 40 cycles, this icon appears for an hour and then turns off automatically. The icon will appear for 5 more cycles, turn off, and then will not appear for another 40 cycles.</li> </ul>

## Cycle chart

Use this chart to set the best cycle and options for you laundry.

Temp.	Spin	Soil Level
5: Extra Hot	5: Extra High	5: Extra Heavy
4: Hot	4: High	4: Heavy
3: Warm	3: Medium	3: Medium
2: Cold	2: Low	2: Light
1: Tap Cold	1: Extra Low	1: Extra Light
	 No Spin	
	No indicator : No Drain	

● : factory setting, ○ : can be selected

Cycle	Temp.					Spin							Soil Level				
	5	4	3	2	1	5	4	3	2	1	⊗	No Drain	5	4	3	2	1
WOOL			●	○	○				●	○	○	○			●		
DELICATES			○	○	●			●	○	○	○	○	○	○	○	○	○
PERM PRESS			●	○	○		○	○	●	○	○	○	○	○	○	○	○
RINSE+SPIN						○	●	○	○	○	○	○					
DRUM CLEAN <sup>+</sup>	●						●								●		
NORMAL	○	○	●	○	○	○	●	○	○		○	○	○	○	●	○	○
SMALL LOAD		○	●	○	○	○	○	●	○	○	○	○	○	○	○	○	●
HEAVY DUTY	○	●	○	○	○	●	○	○	○	○	○	○	○	●	○	○	○
ACTIVWEAR			●	○	○				●	○	○	○	○	○	○	○	○
STEAM SANITIZE	●					○	●	○	○	○	○	○	○	○	○	○	○
STEAM ALLERGEN		●				○	●	○	○	○	○	○	○	○	○	○	○

Cycle	Options		
	Extra Rinse	Super Speed	Pre Soak
WOOL			
DELICATES	○		
PERM PRESS	○		○
RINSE+SPIN	○		
DRUM CLEAN <sup>+</sup>			
NORMAL	○	○	○
SMALL LOAD	○		
HEAVY DUTY	○	○	○
ACTIVWEAR	○		○
STEAM SANITIZE	○		○
STEAM ALLERGEN	○	○	○

# Operations

---

## Delay End

You can set the washer to finish your wash automatically at a later time, choosing a delay of between 1 to 24 hours (in 1 hour increments). The hour displayed indicates the time the wash will finish.

1. Select a cycle and change the cycle settings as necessary.
2. Press **Delay End** repeatedly until a desired end time is set.
3. Press **Start/Pause**.
4. The  indicator turns on with the clock running.
5. To cancel the **Delay End**, restart the washer by pressing **Power**.

## Real-life case

You want to finish a two-hour cycle 3 hours later from now. For this, you add the Delay End option to the current cycle with the 3-hour setting, and press **Start/Pause** at 2:00 p.m. Then, what happens? The washer starts operating at 3:00 p.m., and ends at 5:00 p.m. Provided below is the time line for this example.

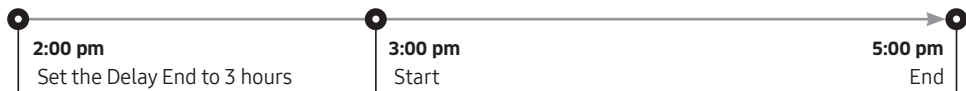

---

## Spin Only

---

If you press the **POWER** button and then press and hold the **Spin** button for 3 seconds, the spin time will be displayed on the display panel.

Then, press the **Spin** button repeatedly until the required spin level is selected, and then press the **START/PAUSE** button.



### NOTE

- Before pressing the Spin Only button to use the Spin Only function, you can select a cycle with the Cycle Selector. If you have selected a cycle, you can only select the spin level corresponding to the selected cycle.



## Child Lock

Child Lock prevents children from playing with your washer.

Once you have activated the Child Lock function, the control panel cannot be activated, preventing children from playing with the washer.

### Activating the Child Lock function

Press and hold both the **Temp.** and **Spin** buttons simultaneously for 3 seconds.

- When you activate the Child Lock function, the door locks and the “Child Lock  lamp illuminates.
- If you press the **START/PAUSE** button after you have activated the Child Lock function, none of the buttons will work except for the **POWER** button.
- If you press a button when the buttons are locked, the “Child Lock  lamp blinks.

### Deactivating the Child Lock function

Press and hold both the **Temp.** and **Spin** buttons simultaneously for approximately 3 seconds.



### WARNING

- When you deactivate the Child Lock function, the door is unlocked and the “Child Lock  is turned off.
- The Child Lock function prevents children or the infirm from accidentally operating the washer and injuring themselves.
- If a child enters the washer, the child may become trapped and suffocate.
- Once you have activated the Child Lock function, it continues working even if the power is turned off.
- Opening the door by force can result in injury due to damage to the product.



### NOTE

- In the Child Lock state, you must first deactivate the Child Lock if you want to add detergent or laundry.
- Your setting will be kept even after restarting the machine.
- You cannot open the door after a wash cycle when the Child Lock is on. Turn the function off before opening the door to take out the laundry.

# Operations

## Special features

### Smart Control (applicable models only)

You can connect to the SmartThings app and control your washer remotely.

#### Connecting your washer

1. Download and open the SmartThings app on your smartphone or tablet (Android & iOS).
2. Tap **Power** to turn on the washer.
3. Tap and hold **Smart Control**.
  - a. The washer enters AP mode and connects to your smartphone or tablet.
  - b. Tap **Smart Control** to authenticate your washer.
  - c. Once the authentication process is complete, your washer is successfully connected to the app.
    - You can use various features available in the SmartThings app.

#### NOTE

- If your washer fails to connect with the SmartThings app, try again.
- Check your router if you experience any Internet connection problem after connecting your washer with the SmartThings app.
- If the Wi-Fi is off, tap and hold **Temp.** and **Smart Control** simultaneously for 3 seconds to turn it on.
- Turning the washer's Wi-Fi on allows you connect to the washer via SmartThings app on your smartphone or tablet, regardless of the power status of the washer. However, the washer appears offline on the SmartThings app if the washer's Wi-Fi is off.
- Close the door before starting the Smart Control function.
- If you use your washer for a while without connecting it to the SmartThings app, a pop-up message about Smart Control will show for 3 seconds.
- If the washer's Wi-Fi is not connected to an AP (access point), the Wi-Fi will turn off when you turn of the power.

#### Stay Connect

Set up the Stay Connect function in your SmartThings app to keep Smart Control turned on at the end of a cycle. Your washer stays connected to the app so you can send additional instructions, whether you are at home or away.

1. If you turn on the Stay Connect function on the SmartThings app, the washer will stay in standby power saving mode after completing a cycle.
  - The Stay Connect function will remain active for up to 24 Hours if the door remains closed.
2. When the Stay Connect function is active, the Smart Control, Door Lock, and Wi-Fi icons are illuminated on your washer display.
3. You can conveniently control your washer, adding rinse, spin or dry cycles using the SmartThings app.

#### NOTE

- The washer switches to standby power saving mode when operation is paused even if the machine is not connected to the SmartThings app.
- In some circumstances, only the Door Lock icon may be illuminated.

---

## SmartThings

---

### Wi-Fi connection

On your smartphone or tablet, go to **Settings** and turn on the wireless connection and select an AP (Access Point).

- This appliance supports the Wi-Fi 2.4 GHz protocols.

### Download

On an app market (Google Play Store, Apple App Store, Samsung Galaxy Apps), find the SmartThings app with a search term of "SmartThings". Download and install the app on your device.

#### NOTE

The app is subject to change without notice for improved performance.

### Log in

You must first log into SmartThings with your Samsung account. To create a new Samsung account, follow the instructions on the app. You don't need a separate app to create your account.

#### NOTE

If you have a Samsung account, use the account to log in. A registered Samsung smartphone or tablet user automatically logs in.

### To register your appliance to SmartThings

1. Make sure your smartphone or tablet is connected to a wireless network. If not, go to **Settings** and turn on the wireless connection and select an AP (Access Point).
2. Open **SmartThings** on your smartphone or tablet.
3. If a message of "A new device is found.", select **Add**.
4. If no message appears, select **+** and select your appliance in a list of devices available. If your appliance is not listed, select **Device Type** > **Specific Device Model**, and then add your appliance manually.
5. Register your appliance to the SmartThings app as follows.
  - a. Add your appliance to SmartThings. Make sure your appliance is connected to SmartThings.
  - b. When registration is complete, your appliance appears on your smartphone or tablet.

If you're moving out, we recommend you completely wipe the appliance and do a network reset on it before you leave it behind.

If you're moving in, the easiest way to take control and remove the previous user's access is to add it to SmartThings yourself. But if you don't plan on using SmartThings, a network reset should be performed to protect your privacy. In rental properties, there's a regular change of ownership. To ensure resident privacy, Wi-Fi and/or other connectivity settings should be reset at each change of resident. Please refer to factory reset instructions in this manual.

# Operations

---

## NOTE

- Due to different product development periods, the APP names will be different. Samsung SmartThings, SmartThings, Samsung Connect, Samsung Smart Home, and Samsung Smart Connect have the same meaning.
- The product will be inconsistent with the APP interface and the manual due to functional iterations. Please refer to the actual APP interface.

# Maintenance

---

Keep the washer clean to prevent deteriorated performance and to preserve its life cycle.

## WARNING

Certain internal parts are intentionally not grounded and may present a risk of electric shock only during servicing. Service personnel – Do not contact the following parts while the appliance is energized: Control board, heat sink, motor, inlet valve and pump.

## DRUM CLEAN<sup>+</sup>

---

Perform this cycle regularly to clean the drum by removing bacteria from it. This cycle heats the water between 60 °C and 70 °C, and it also removes accumulated dirt from the rubber door gasket.

1. Press **Power** to turn on the washer.
2. Turn the **Cycle Selector** to select **DRUM CLEAN<sup>+</sup>**.
3. Press and hold **Start/Pause**.

## NOTE

- The water temperature for **DRUM CLEAN<sup>+</sup>** is set to 70 °C, which cannot be changed.
- It is recommended to run the **DRUM CLEAN<sup>+</sup>** cycle once every 40 washes.
- To prevent limescale, add the proper amount of detergent according to your local water hardness or add a water softener additive together with the detergent.

## DRUM CLEAN<sup>+</sup> reminder

Depending on the model, the **DRUM CLEAN<sup>+</sup>** reminder is either an icon or an LED.

For icons, the icon lights up on the control panel.

For LEDs, the LED lights up next to **DRUM CLEAN<sup>+</sup>**, or on the option area of the control panel.

- The **DRUM CLEAN<sup>+</sup>** reminder blinks on the control panel once every 40 washes. It is advisable to perform **DRUM CLEAN<sup>+</sup>** regularly.
- When you first see this reminder blinking, you can ignore the reminder for 6 consecutive washes. From the 7<sup>th</sup> wash, the reminder no longer appears. However, it appears again on the second 40<sup>th</sup> wash.
- Even after the last process is terminated, the "0" message may remain.
- Even if "0" does not disappear, the machine operates normally.
- It is recommended to run the cycle regularly for hygienic purposes.

# Maintenance

## Emergency drain

In case of a power failure, drain the water inside the drum before taking out the laundry.

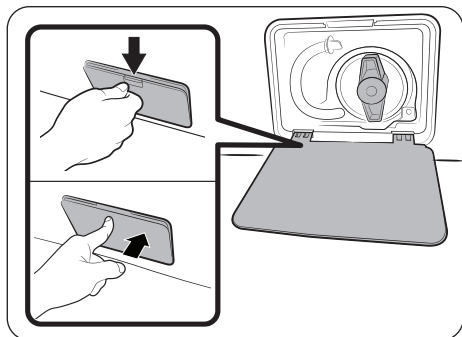

1. Power off and unplug the washer from the electrical outlet.
2. Open the **filter cover**.
  - TYPE 1: Push down the latch of the filter cover to open.
  - TYPE 2: Gently press the top area of the filter cover to open.

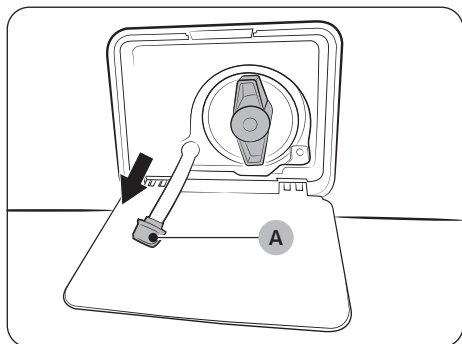

3. Put an empty, spacious container around the cover, and stretch the emergency drain tube to the container while holding the **tube cap (A)**.

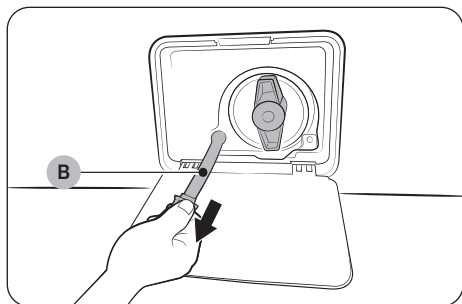

4. Open the tube cap and let water in the **emergency drain tube (B)** flow into the container.
5. When done, close the tube cap, and reinsert the tube. Then, close the filter cover.

### NOTE

Use a spacious container because the water in the drum may be more than expected.

---

## Cleaning

---

### Surface of the washer

Use a soft cloth with a nonabrasive household detergent. Do not spray water onto the washer.

### Mesh filter

Clean the mesh filter of the water hose once or twice a year.

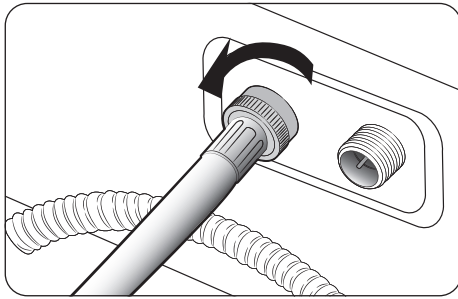

1. Turn off the washer, and unplug the power cord.
2. Close the water tap.
3. Loosen and disconnect the water hose from the back of the washer. Cover the hose with a cloth to prevent water from gushing out.

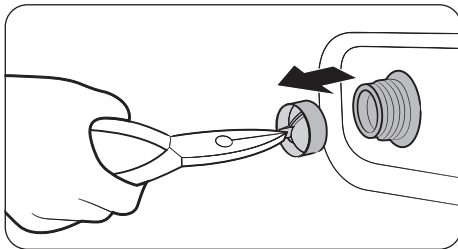

4. Use pliers to pull out the mesh filter from the inlet valve.
5. Submerge the mesh filter deeply in water so that the threaded connector is also submerged.
6. Dry the mesh filter completely in the shade.
7. Reinsert the mesh filter into the inlet valve, and reconnect the water hose to the inlet valve.
8. Open the water tap.

### NOTE

If the mesh filter is clogged, an information code of “4C” appears on the screen.

# Maintenance

## Pump filter

It is advisable to clean the pump filter every 2 months to prevent its clogging. A clogged pump filter may reduce the bubble effect.

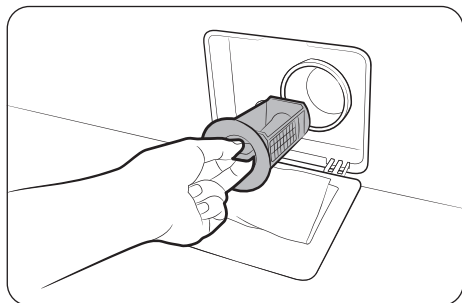

1. Turn off the washer, and unplug the power cord.
2. Drain the remaining water inside the drum. See the **Emergency drain** section.
3. Open the **filter cover**.
4. Turn the pump filter knob to the left, and drain off the remaining water.

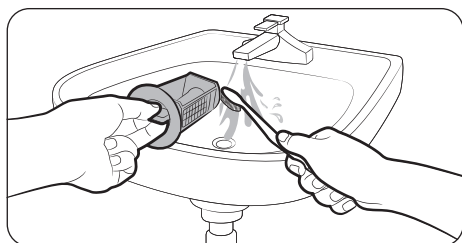

5. Clean the pump filter using soft brushes. Make sure the drain pump propeller inside the filter is unclogged.
6. Reinsert the pump filter, and turn the filter knob to the right.

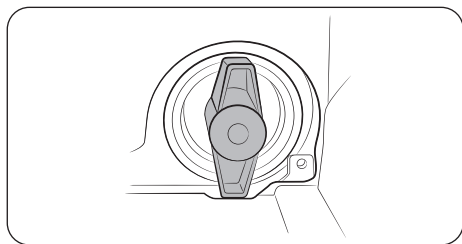

### NOTE

- Some pump filters feature a safety knob that is designed to prevent accidents by children. To open the safety knob of the pump filter, push in and turn it anticlockwise. The spring mechanism of the safety knob helps open the filter.
- To close the safety knob of the pump filter, turn it clockwise. The spring makes a rattling sound, which is normal.

### NOTE

- If the pump filter is clogged, an information code of **"5C"** appears on the screen.

### CAUTION

- Make sure the filter knob is closed properly after cleaning the filter. Otherwise, this may cause a leak.
- Make sure the filter is inserted properly after cleaning it. Otherwise, this may cause an operational failure or a leak.

## Detergent drawer

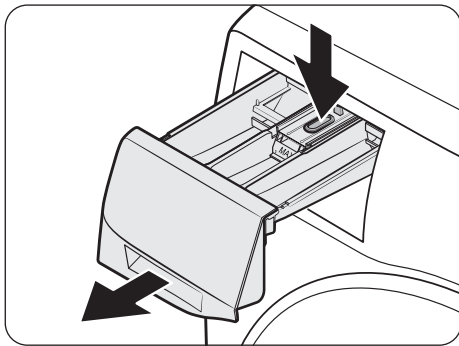

1. While holding down the **release lever** inside the drawer, slide open the drawer.

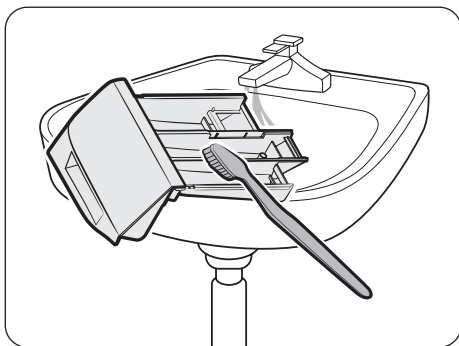

2. Clean the drawer components in flowing water using a soft brush.

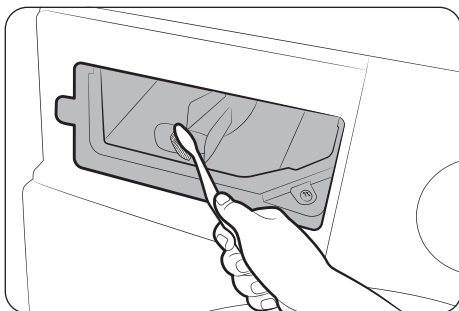

3. Clean the drawer recess using a bottle brush to remove detergent residues and limescale on the drawer recess.
4. Reinsert the liquid detergent container to the drawer.
5. Slide the drawer inward to close it.

### **NOTE**

Make sure the drawer recess is completely dry before inserting the detergent drawer.

### **NOTE**

To remove remaining detergent, perform the **Rinse+Spin** cycle with the drum being empty.

# Maintenance

## Door diaphragm

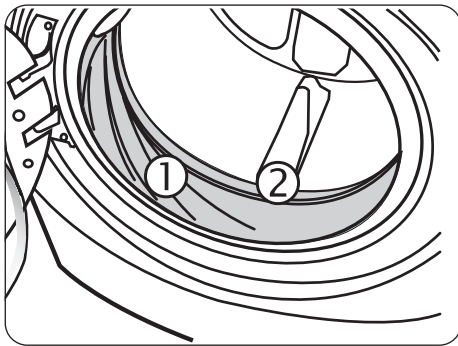

1. Open the washer door and remove any clothing or items from the washer.
2. Check if there are any foreign substances on the grey Diaphragm ① between the lid and the drum.  
To check this, turn the Diaphragm ② out.
3. If there are any foreign substances, remove them.
4. If you find stained areas, wipe them down using the procedure below:
  - a) Carefully combine  $\frac{3}{4}$  cup (177 mL) of liquid chlorine bleach with 1 gal. (3.8 L) of warm tap water.
  - b) Wipe the Diaphragm area with the dilute solution using a damp cloth.
  - c) Let stand 5 minutes.
  - d) Wipe down the area thoroughly with a dry cloth and let the washer interior air dry with the door open.

### CAUTION

Wear rubber gloves when cleaning for prolonged periods.  
Refer to the bleach manufacturer's instructions for proper use.

## Recovery from freezing

The washer may freeze when it drops below 0 °C.

1. Turn off the washer, and unplug the power cord.
2. Pour warm water over the water tap to loosen the water hose.
3. Disconnect the water hose, and soak it in warm water.
4. Pour warm water into the drum and leave it for about 10 minutes.
5. Reconnect the water hose to the water tap.

### NOTE

If the washer still doesn't operate normally, repeat the above steps until it operates normally.



---

## Care for an extended period of non-use

---

Avoid leaving the washer unused for an extended time. If this is the case, drain the washer and unplug the power cord.

1. Turn the **Navigation dial** to select **Rinse+Spin**.
2. Empty the drum, and then Press **Start/Pause**.
3. When the cycle is complete, close the water tap and disconnect the water hose.
4. Turn off the washer, and unplug the power cord.
5. Open the door to let air circulate through the drum.

## Cleaning the exterior

---

1. Turn off the water faucets after finishing the day's washing.  
This will shut off the water supply to your washer and prevent the unlikely possibility of damage from escaping water. Leave the door open to allow the inside of your washer to dry out.
2. Use a soft cloth to wipe up all detergent, bleach or other spills as they occur.  
Clean the following as recommended below:
  - Control Panel – Clean with a soft, damp cloth.  
Do not use abrasive powders or cleaning pads. Do not spray cleaners directly on the panel.
  - Cabinet – Clean with soap and water.

## Cleaning the interior

---

Clean the interior of your washer periodically to remove any dirt, soil, odor, mold, mildew, or bacterial residue that may remain in your washer as a result of washing clothes.

### CAUTION

Failure to follow these instructions may result in unpleasant conditions, including odors and/or permanent stains on your washer or laundry.

### NOTE

Hard water deposits may be removed, if needed. Use a cleaner labeled “Washer safe”.



# Troubleshooting

## Checkpoints

If you encounter a problem with the washer, first check the table below and try the suggestions.

Problem	Action
<b>Does not start.</b>	<ul style="list-style-type: none"> <li>• Make sure the washer is plugged in.</li> <li>• Make sure the door is properly closed.</li> <li>• Make sure the water taps are open.</li> <li>• Make sure to press or tap <b>Start/Pause</b> to start the washer.</li> <li>• Make sure Child Lock  is not activated.</li> <li>• Before the washer starts to fill, it will make a series of clicking noises to check the door lock and does a quick drain.</li> <li>• Check the fuse or reset the circuit breaker.</li> </ul>
<b>Water supply is insufficient, or no water is supplied.</b>	<ul style="list-style-type: none"> <li>• Fully open the water tap.</li> <li>• Make sure the door is properly closed.</li> <li>• Make sure the water supply hose is not frozen.</li> <li>• Make sure the water supply hose is not kinked or clogged.</li> <li>• Make sure there is sufficient water pressure.</li> <li>• Make sure the mesh filter of the water supply hose is clean.</li> </ul>
<b>After a cycle, detergent remains in the detergent drawer.</b>	<ul style="list-style-type: none"> <li>• Make sure the washer is running with sufficient water pressure.</li> <li>• Make sure the detergent is added to the centre of the detergent drawer.</li> <li>• Make sure the rinse cap is inserted properly.</li> <li>• If using granular detergent, make sure the detergent selector is in the upper position.</li> <li>• Remove the rinse cap and clean the detergent drawer.</li> </ul>
<b>Excessive vibrations or makes noise.</b>	<ul style="list-style-type: none"> <li>• Make sure the washer is installed on a level, solid floor that is not slippery. If the floor is not level, use the levelling feet to adjust the height of the washer.</li> <li>• Make sure the shipping bolts are removed.</li> <li>• Make sure the washer is not contacting any other object.</li> <li>• Make sure the laundry load is balanced.</li> <li>• The motor can cause noise during normal operation.</li> <li>• Overalls or metal-decorated clothes can cause noise while being washed. This is normal.</li> <li>• Metal objects such as coins can cause noise. After washing, remove these objects from the drum or filter case.</li> </ul>

Problem	Action
<p><b>Does not drain and/ or spin.</b></p>	<ul style="list-style-type: none"> <li>• Make sure the drain hose is straight all the way to the drain system. If you encounter a drain restriction, call for service.</li> <li>• Make sure the debris filter is not clogged.</li> <li>• Close the door and press or tap <b>Start/Pause</b>. For your safety, the washer will not tumble or spin unless the door is closed.</li> <li>• Make sure the drain hose is not frozen or clogged.</li> <li>• Make sure the drain hose is connected to a drain system that is not clogged.</li> <li>• If the washer is not supplied with sufficient power, the washer temporarily will not drain or spin. As soon as the washer regains sufficient power, it will operate normally.</li> </ul> <p>Spinning does not work.</p> <ul style="list-style-type: none"> <li>• Make sure laundry is spread out evenly.</li> <li>• Make sure the washer is on a flat, stable surface.</li> <li>• Redistribute the load. If only one item of clothing needs washing, such as a bathrobe or pair of jeans, the final spin result might be unsatisfactory, and an “<b>Ub</b>” check message will be shown in the display.</li> </ul>
<p><b>The door does not open.</b></p>	<ul style="list-style-type: none"> <li>• Press or tap <b>Start/Pause</b> to stop the washer.</li> <li>• It may take a few moments for the door lock mechanism to disengage.</li> <li>• The door will not open until 3 minutes after the washer has stopped or the power turned off.</li> <li>• Make sure all the water in the drum is drained.</li> <li>• The door may not open if water remains in the drum. Drain the drum and open the door manually.</li> <li>• Make sure the door lock light is off. The door lock light turns off after the washer has drained.</li> </ul>
<p><b>Excessive suds.</b></p>	<ul style="list-style-type: none"> <li>• Make sure you use the recommended types of detergent as appropriate.</li> <li>• Use high efficiency (HE) detergent to prevent oversudsing.</li> <li>• Reduce the detergent amount for soft water, small loads, or lightly soiled loads.</li> <li>• Non-HE detergent is not recommended.</li> </ul>
<p><b>Cannot apply additional detergent.</b></p>	<ul style="list-style-type: none"> <li>• Make sure the remaining amount of detergent and fabric softener is not over the limit.</li> </ul>

# Troubleshooting

Problem	Action
<p><b>Stops.</b></p>	<ul style="list-style-type: none"> <li>• Plug the power cord into a live electrical outlet.</li> <li>• Check the fuse or reset the circuit breaker.</li> <li>• Close the door and press the <b>Start/Pause</b> button to start the washer. For your safety, the washer will not tumble or spin unless the door is closed.</li> <li>• Before the washer starts to fill, it will make a series of clicking noises to check the door lock and does a quick drain.</li> <li>• There may be a pause or soak period in the cycle. Wait briefly and the washer may start.</li> <li>• Make sure the mesh filter of the water supply hose at the water taps are not clogged. Periodically clean the mesh filter.</li> <li>• If the washer is not supplied with sufficient power, the washer temporarily will not drain or spin. As soon as the washer regains sufficient power, it will operate normally.</li> </ul>
<p><b>Fills with the wrong water temperature.</b></p>	<ul style="list-style-type: none"> <li>• Fully open both taps.</li> <li>• Make sure the temperature selection is correct.</li> <li>• Make sure the hoses are connected to the correct taps. Flush water lines.</li> <li>• Make sure the water heater is set to supply a minimum 120 °F (49 °C) hot water at the tap. Also, check the water heater capacity and recovery rate.</li> <li>• Disconnect the hoses and clean the mesh filter. The mesh filter may be clogged.</li> <li>• While the washer fills, the water temperature may change as the automatic temperature control feature checks incoming water temperature. This is normal.</li> <li>• While the washer fills, you may notice just hot and/or just cold water going through the dispenser when cold or warm temperatures are selected. This is a normal function of the automatic temperature control feature as the washer determines the water temperature.</li> </ul>
<p><b>Load is wet at the end of a cycle.</b></p>	<ul style="list-style-type: none"> <li>• Use the 4 or 5 spin speed.</li> <li>• Use high efficiency (HE) detergent to reduce oversudsing.</li> <li>• Load is too small. Small loads (one or two items) may become unbalanced and not spin completely.</li> <li>• Make sure the drain hose is not kinked or clogged.</li> </ul>

Problem	Action
<b>Leaks water.</b>	<ul style="list-style-type: none"> <li>• Make sure the door is properly closed.</li> <li>• Make sure all hose connections are tight.</li> <li>• Make sure the end of the drain hose is correctly inserted and secured to the drain system.</li> <li>• Avoid overloading.</li> <li>• Use high efficiency (HE) detergent to prevent oversudsing.</li> <li>• Check if there is something stuck between the door and the diaphragm.               <ul style="list-style-type: none"> <li>- If there is something stuck between the door and the diaphragm, it may cause a leak or damage to the diaphragm.</li> </ul> </li> </ul>
<b>Has odours.</b>	<ul style="list-style-type: none"> <li>• Excessive suds collect in recesses and can cause foul odours.</li> <li>• Run cleansing cycles to sanitize periodically.</li> <li>• Clean the door seal (diaphragm).</li> <li>• Dry the washer interior after a cycle has finished.</li> </ul>
<b>No bubbles are seen (Bubble models only).</b>	<ul style="list-style-type: none"> <li>• Overloading may screen bubbles.</li> <li>• Severely contaminated laundry may not generate bubbles.</li> </ul>
<b>Increased time of washing</b>	<ul style="list-style-type: none"> <li>• The actual washing time may differ from the estimated time initially displayed on the control panel upon cycle selection.</li> </ul>
<b>Stains on the clothes.</b>	<ul style="list-style-type: none"> <li>• Do not pour fabric softener directly onto your clothes. Applying it directly to clothing can leave stains (for example, oily spots or ingrained dirt) that might be difficult to remove.</li> </ul>

- If a problem persists, contact a service center.

# Troubleshooting

## Information codes

If the washer fails to operate, you may see an information code on the screen. Check the table below and try the suggestions.

Code	Action
4C	<p>Water is not supplied.</p> <ul style="list-style-type: none"><li>• Make sure the water taps are open.</li><li>• Make sure the water hoses are not clogged.</li><li>• Make sure the water taps are not frozen.</li><li>• Make sure the washer is running with sufficient water pressure.</li><li>• Make sure that the cold water tap and the hot water tap are properly connected.</li><li>• Clean the mesh filter as it may be clogged.</li><li>• When the "4C" message appears, the machine drains water for 3 minutes. In the meantime, the power button will be disabled.</li></ul>
4C2	<ul style="list-style-type: none"><li>• Make sure the cold water supply hose is firmly connected to the cold water tap. If it is connected to the hot water tap, the laundry may be deformed with some cycles.</li></ul>
5C	<p>Water is not draining.</p> <ul style="list-style-type: none"><li>• Make sure the drain hose is not frozen or clogged.</li><li>• Make sure the drain hose is positioned correctly, depending on the connection type.</li><li>• Clean the debris filter as it may be clogged.</li><li>• Make sure the drain hose is straightened all the way to the drain system.</li><li>• If the information code remains, contact a customer service centre.</li></ul>
dC	<p>Operating the washer with the door open.</p> <ul style="list-style-type: none"><li>• Make sure the door is properly closed.</li><li>• Make sure laundry is not caught in the door.</li></ul>
OC	<p>Water is overflowed.</p> <ul style="list-style-type: none"><li>• Restart after spinning.</li><li>• If the information code remains on the display, contact a local Samsung service centre.</li></ul>
LC, LC1	<p>Check the drain hose.</p> <ul style="list-style-type: none"><li>• Make sure the end of the drain hose is not placed on the floor.</li><li>• Make sure the drain hose is not clogged.</li><li>• If the information code remains, contact a customer service centre.</li></ul>
3C	<p>Check the motor for operation.</p> <ul style="list-style-type: none"><li>• Try restarting the cycle.</li><li>• If the information code remains, contact a customer service centre.</li></ul>

Code	Action
UC	The electronic control needs to be checked. <ul style="list-style-type: none"> <li>• Check if power is supplied properly.</li> <li>• If the information code remains, contact a customer service centre.</li> </ul>
	Low voltage detected. <ul style="list-style-type: none"> <li>• Check if the power cord is plugged in.</li> <li>• If the information code remains, contact a customer service centre.</li> </ul>
HC	High temperature heating check. <ul style="list-style-type: none"> <li>• If the information code remains, contact a customer service centre.</li> </ul>
1C	The Water Level sensor is not working properly. <ul style="list-style-type: none"> <li>• Try power off and restarting the cycle.</li> <li>• If the information code remains, contact a customer service centre.</li> </ul>
AC	Check communications between main and sub PBAs. <ul style="list-style-type: none"> <li>• Try power off and restarting the cycle.</li> <li>• If the information code remains, contact a customer service centre.</li> </ul>
0	The machine does not turn off automatically after the last spinning process, and the "0" message remains. <ul style="list-style-type: none"> <li>• The machine operates normally without running the <b>DRUM CLEAN+</b> cycle. However, it is recommended to run the cycle for hygienic purposes.</li> </ul>
Ub	Spinning does not work. <ul style="list-style-type: none"> <li>• Make sure laundry is spread out evenly.</li> <li>• Make sure the washer is on a flat, stable surface.</li> <li>• Redistribute the load. If only one item of clothing needs washing, such as a bathrobe or pair of jeans, the final spin result might be unsatisfactory, and an "<b>Ub</b>" check message will be shown in the display.</li> </ul>





If any information code keeps appearing on the screen, contact a local Samsung service centre.

# Specifications



## Fabric care chart

The following symbols provide garment care direction. The clothing care labels include symbols for drying, bleaching, drying and ironing, or dry cleaning when necessary. The use of symbols ensures consistency among garment manufacturers of domestic and imported items. Follow care label directions to optimize garment life and reduce laundering problems.

### Wash cycle

	Normal
	Permanent press/Wrinkle resistant/ Wrinkle control
	Gentle/Delicates
	Hand wash



### Water temperature

	Hot
	Warm
	Cold



### NOTE

This represents appropriate wash water temperatures for various items. The temperature range for Hot below 135°F/57°C, for Warm below 105°F/41°C and for Cold below 85°F/29°C. (Wash water temperature must be a minimum of 16 °C for detergent activation and effective cleaning.)



### Bleach

	Any bleach (when needed)
	Only non-chlorine (color-safe) bleach (when needed)
	Tumble dry





### Normal

	Permanent press/Wrinkle resistant/ Wrinkle control
	Gentle/Delicates



### Special instructions

	Line dry/Hang to dry
	Drip dry
	Dry flat







### Heat setting

	High
	Medium
	Low
	Any heat
	No heat / Air





### Iron dry or steam temperatures

	High
	Medium
	Low

### Warning symbols for laundering

	Do not wash
	Do not wring
	Do not bleach
	Do not tumble dry
	No steam (added to iron)
	Do not iron

### Dry-clean

	Dry-clean
	Do not dry-clean
	Line dry / Hang to dry
	Drip dry
	Dry flat

---

## Protecting the environment

---

- This appliance is manufactured from recyclable materials. If you decide to dispose of it, please observe local waste disposal regulations. Cut off the power cord so that the appliance cannot be connected to a power source. Remove the lid so that animals and small children cannot get trapped inside the appliance.
- Do not exceed the detergent quantities recommended in the detergent manufacturers' instructions.
- Use stain removal products and bleaches before the wash cycle only when necessary.
- Save water and electricity by only washing full loads (the exact amount depends upon the program used).

## Declaration of conformity

---

This appliance complies with UL2157.

## Specification sheet

---

Type		Front loading washer	
Model name		WW25FG5****	
Water pressure (psi (kPa))		20 - 116 (137 - 800)	
NET weight (lb (kg))		159 (72)	
Spin revolutions		1400 rpm	
Heater rating		900 W	
Power consumption	Washing	120 V	200 W
	Washing and heating		1150 W
	Spin		550 W
	Drain		80 W

### NOTE

- You can fill the tub with dry, unfolded clothes, but **DO NOT OVERLOAD** the tub.

# LIMITED WARRANTY (U.S.A.)

---

## SAMSUNG WASHER

---

### LIMITED WARRANTY TO ORIGINAL CONSUMER PURCHASER WITH PROOF OF PURCHASE AND/OR PROOF OF DELIVERY

This SAMSUNG brand product, as supplied and distributed by SAMSUNG ELECTRONICS AMERICA, INC. (SAMSUNG) and delivered new, in the original carton to the original consumer purchaser, is warranted by SAMSUNG against manufacturing defects in materials or workmanship for the following limited warranty periods, starting on the date of delivery to the original consumer purchaser:

Parts and labor : One (1) year

Stainless tub part (Part Only) : Three (3) years

Washing DIT (Digital Inverter Motor) motor part (Part Only):

- Ten (10) years

This limited warranty is valid only on products purchased and used in the United States that have been installed, operated, and maintained according to the instructions attached to or furnished with the product. To receive warranty service, the purchaser must contact SAMSUNG at the address or phone number provided below for problem determination and service procedures. Warranty service can only be performed by a SAMSUNG authorized service center. The original dated bill of sale and/or proof of delivery must be presented upon request to SAMSUNG or SAMSUNG's authorized service center to receive warranty service.

SAMSUNG will provide in-home service within the contiguous United States during the warranty period at no charge, subject to availability of SAMSUNG authorized servicers within the customer's geographic area. If in-home service is not available, SAMSUNG may elect, at its option, to provide transportation of the product to and from an authorized service center. If the product is located in an area where service by a SAMSUNG authorized servicer is not available, you may be responsible for a trip charge or required to bring the product to a SAMSUNG authorized service center for service.

To receive in-home service, product must be unobstructed and accessible to the service agent.

During the applicable warranty period, a product will be repaired, replaced, or the purchase price refunded, at the sole option of SAMSUNG. SAMSUNG may use new or reconditioned parts in repairing a product, or replace the product with a new or reconditioned product. SAMSUNG may also replace any part covered by this warranty with a new or reconditioned part. Replacement parts and products are warranted for the remaining portion of the original product's warranty or ninety (90) days, whichever is longer. All replaced parts and products are the property of SAMSUNG and you must return them to SAMSUNG.



---

This limited warranty covers manufacturing defects in materials or workmanship encountered in normal household, noncommercial use of this product and shall not cover the following: damage that occurs in shipment, delivery, installation, and uses for which this product was not intended; damage caused by unauthorized modification or alteration of the product; product where the original factory serial numbers have been removed, defaced, changed in any way, or cannot be readily determined; cosmetic damage including scratches, dents, chips, and other damage to the product's finishes; damage caused by abuse, misuse, pest infestations, accident, fire, floods, or other acts of nature or God; damage caused by use of equipment, utilities, services, parts, supplies, accessories, applications, installations, repairs, external wiring or connectors not supplied or authorized by SAMSUNG; damage caused by incorrect electrical line current, voltage, fluctuations and surges; damage caused by failure to operate and maintain the product according to instructions; in-home instruction on how to use your product; and service to correct installation not in accordance with electrical or plumbing codes or correction of household electrical or plumbing (i.e., house wiring, fuses, or water inlet hoses). The cost of repair or replacement under these excluded circumstances shall be the customer's responsibility.

Visits by an authorized servicer to explain product functions, maintenance or installation are not covered by this limited warranty. Please contact SAMSUNG at the number below for assistance with any of these issues.

#### **EXCLUSION OF IMPLIED WARRANTIES**

IMPLIED WARRANTIES, INCLUDING THE IMPLIED WARRANTIES OF MERCHANTABILITY OR FITNESS FOR A PARTICULAR PURPOSE, ARE LIMITED TO ONE YEAR OR THE SHORTEST PERIOD ALLOWED BY LAW.

Some states do not allow limitations on how long an implied warranty lasts, so the above limitations or exclusions may not apply to you. This warranty gives you specific rights, and you may also have other rights, which vary from state to state.



# LIMITED WARRANTY (U.S.A.)

---

## LIMITATION OF REMEDIES

YOUR SOLE AND EXCLUSIVE REMEDY IS PRODUCT REPAIR, PRODUCT REPLACEMENT, OR REFUND OF THE PURCHASE PRICE AT SAMSUNG'S OPTION, AS PROVIDED IN THIS LIMITED WARRANTY. SAMSUNG SHALL NOT BE LIABLE FOR SPECIAL, INCIDENTAL OR CONSEQUENTIAL DAMAGES, INCLUDING BUT NOT LIMITED TO TIME AWAY FROM WORK, HOTELS AND/OR RESTAURANT MEALS, REMODELING EXPENSES, LOSS OF REVENUE OR PROFITS, FAILURE TO REALIZE SAVINGS OR OTHER BENEFITS REGARDLESS OF THE LEGAL THEORY ON WHICH THE CLAIM IS BASED, AND EVEN IF SAMSUNG HAS BEEN ADVISED OF THE POSSIBILITY OF SUCH DAMAGES. Some states do not allow exclusion or limitation of incidental or consequential damages, so the above limitations or exclusions may not apply to you. This warranty gives you specific rights, and you may also have other rights, which vary from state to state.

SAMSUNG does not warrant uninterrupted or error-free operation of the product. No warranty or guarantee given by any other person, firm, or corporation with respect to this product shall be binding on SAMSUNG.

To obtain warranty service, please contact SAMSUNG at:

Samsung Electronics America, Inc.

700 Sylvan Avenue,

Englewood Cliffs, NJ 07632

1-800-SAMSUNG (726-7864)

[www.samsung.com/support](http://www.samsung.com/support)

# WARRANTY (CANADA)

---

## SAMSUNG WASHER

---

### LIMITED WARRANTY TO ORIGINAL PURCHASER

This SAMSUNG brand product, as supplied and distributed by SAMSUNG ELECTRONICS CANADA, INC. (SAMSUNG) and delivered new, in the original carton to the original consumer purchaser, is warranted by SAMSUNG against manufacturing defects in materials and workmanship for a limited warranty period of:

Parts and labor : One (1) year

Washing DIT (Digital Inverter Motor) motor part (Part Only):

- Ten (10) years

This limited warranty begins on the original date of purchase, and is valid only on products purchased and used in the Canada. To receive warranty service, the purchaser must contact SAMSUNG for problem determination and service procedures. Warranty service can only be performed by a SAMSUNG authorized service center. The original dated bill of sale must be presented upon request as proof of purchase to SAMSUNG or SAMSUNG's authorized service center. SAMSUNG will provide in-home service during the warranty period at no charge, subject to availability within the Canada. In-home service is not available in all areas.

To receive in-home service, product must be unobstructed and accessible to the service agent. If service is not available, SAMSUNG may elect to provide transportation of the product to and from an authorized service center.

SAMSUNG will repair, replace, or refund this product at our option and at no charge as stipulated herein, with new or reconditioned parts or products if found to be defective during the limited warranty period specified above. All replaced parts and products become the property of SAMSUNG and must be returned to SAMSUNG. Replacement parts and products assume the remaining original warranty, or ninety (90) days, whichever is longer. This limited warranty covers manufacturing defects in materials and workmanship encountered in normal, noncommercial use of this product and shall not apply to the following: damage that occurs in shipment; delivery and installation; applications and uses for which this product was not intended; altered product or serial numbers; cosmetic damage or exterior finish; accidents, abuse, neglect, fire, water, lightning, or other acts of nature or God; use of products, equipment, systems, utilities, services, parts, supplies, accessories, applications, installations, repairs, external wiring or connectors not supplied or authorized by SAMSUNG that damage this product or result in service problems; incorrect electrical line voltage, fluctuations and surges; customer adjustments and failure to follow operating instructions, maintenance and environmental instructions that are covered and prescribed in the instruction book; product removal and reinstallation; problems caused by pest infestations. This limited warranty does not cover problems resulting from incorrect electric current, voltage or supply, light bulbs, house fuses, house wiring, cost of a service call for instructions, or fixing installation errors. SAMSUNG does not warrant uninterrupted or error-free operation of the product.

EXCEPT AS SET FORTH HEREIN, THERE ARE NO WARRANTIES ON THIS PRODUCT EITHER EXPRESS OR IMPLIED, AND SAMSUNG DISCLAIMS ALL WARRANTIES INCLUDING, BUT NOT LIMITED TO, ANY IMPLIED WARRANTIES OF MERCHANTABILITY, INFRINGEMENT OR FITNESS FOR A PARTICULAR PURPOSE.

# WARRANTY (CANADA)

---

NO WARRANTY OR GUARANTEE GIVEN BY ANY PERSON, FIRM, OR CORPORATION WITH RESPECT TO THIS PRODUCT SHALL BE BINDING ON SAMSUNG. SAMSUNG SHALL NOT BE LIABLE FOR LOSS OF REVENUE OR PROFITS, FAILURE TO REALIZE SAVINGS OR OTHER BENEFITS, OR ANY OTHER SPECIAL, INCIDENTAL OR CONSEQUENTIAL DAMAGES CAUSED BY THE USE, MISUSE, OR INABILITY TO USE THIS PRODUCT, REGARDLESS OF THE LEGAL THEORY ON WHICH THE CLAIM IS BASED, AND EVEN IF SAMSUNG HAS BEEN ADVISED OF THE POSSIBILITY OF SUCH DAMAGES.

NOR SHALL RECOVERY OF ANY KIND AGAINST SAMSUNG BE GREATER IN AMOUNT THAN THE PURCHASE PRICE OF THE PRODUCT SOLD BY SAMSUNG AND CAUSING THE ALLEGED DAMAGE. WITHOUT LIMITING THE FOREGOING, PURCHASER ASSUMES ALL RISK AND LIABILITY FOR LOSS, DAMAGE, OR INJURY TO PURCHASER AND PURCHASER'S PROPERTY AND TO OTHERS AND THEIR PROPERTY ARISING OUT OF THE USE, MISUSE, OR INABILITY TO USE THIS PRODUCT. THIS LIMITED WARRANTY SHALL NOT EXTEND TO ANYONE OTHER THAN THE ORIGINAL PURCHASER OF THIS PRODUCT, IS NONTRANSFERABLE AND STATES YOUR EXCLUSIVE REMEDY.

Some provinces do not allow limitations on how long an implied warranty lasts, or the exclusion or limitation of incidental or consequential damages, so the above limitations or exclusions may not apply to you.

This warranty gives you specific rights, and you may also have other rights, which vary from province to province.

To obtain warranty service, please contact SAMSUNG at:

**Samsung Electronics Canada Inc.**

**2050 Derry Road West,**

**Mississauga, Ontario L5N 0B9 Canada.**

**1-800-Samsung (726-7864)**

**[www.samsung.com/support](http://www.samsung.com/support)**

Visits by a Service Engineer to explain functions, maintenance, or installation are not covered by warranty.

Please visit [www.samsung.com/support](http://www.samsung.com/support) for help with any of these issues.





Scan the QR code\* or visit  
[www.samsung.com/spsn](http://www.samsung.com/spsn)  
to view our helpful  
How-to Videos and Live Shows

\*Requires reader to be installed on your smartphone

Scan this with your smartphone

## QUESTIONS OR COMMENTS?

COUNTRY	CALL	OR VISIT US ONLINE AT
U.S.A - Consumer Electronics	1-800-SAMSUNG (726-7864)	<a href="http://www.samsung.com/support">www.samsung.com/support</a>
CANADA	1-800-Samsung (726-7864)	



DC68-000000-01