

MODELS

SMC1585BB / SMC1585BS SMC1585BW

B = Black, S = Stainless Steel, W = White



SMC1585BS

PRECAUTIONS TO AVOID POSSIBLE EXPOSURE TO EXCESSIVE MICROWAVE ENERGY	2	MANUAL OPERATION	15
CUSTOMER ASSISTANCE	3	MICROWAVE FEATURES	16
US CONSUMER LIMITED WARRANTY.....	4	MICROWAVE OVEN COOKING	17-19
CANADA CONSUMER LIMITED WARRANTY.....	5	CONVECTION AUTOMATIC OPERATION	20-25
IMPORTANT SAFETY INSTRUCTIONS.....	6-7	MANUAL CONVECTION AND AUTOMATIC MIX COOKING	26-28
INSTALLATION INSTRUCTIONS	7	OTHER FEATURES	29-30
GROUNDING INSTRUCTIONS	8	CLEANING AND CARE	31
INFORMATION YOU NEED TO KNOW.....	9-12	SERVICE CALL CHECK	32
PART NAMES.....	13-14	SPECIFICATIONS.....	33
BEFORE OPERATING.....	15		

PRECAUTIONS TO AVOID POSSIBLE EXPOSURE TO EXCESSIVE MICROWAVE ENERGY

- (a)** Do not attempt to operate this oven with the door open since open-door operation can result in harmful exposure to microwave energy. It is important not to defeat or tamper with the safety interlocks.
- (b)** Do not place any object between the oven front face and the door or allow soil or cleaner residue to accumulate on sealing surfaces.
- (c)** Do not operate the oven if it is damaged. It is particularly important that the oven door close properly and that there is no damage to the: (1) door (bent), (2) hinges and latches (broken or loosened), (3) door seals and sealing surfaces.
- (d)** The oven should not be adjusted or repaired by anyone except properly qualified service personnel.

CUSTOMER ASSISTANCE

IMPORTANT! Register within 10 days of purchase.

Register ONLINE at www.sharppusa.com/productregistration

To aid in reporting this appliance, please record below the model number and serial number located on the unit. We also suggest you record all the information listed and retain for future reference.

MODEL NUMBER _____ **SERIAL NUMBER** _____

DATE OF PURCHASE _____ / _____ / _____

DEALER _____ **TELEPHONE** _____

SERVICER _____ **TELEPHONE** _____

FOR US

TO PHONE: **CALL 1-800-BE-SHARP (237-4277) for:**
SERVICE (for your nearest Sharp Authorized Servicer)
PARTS (for your authorized parts distributor)
ADDITIONAL CUSTOMER INFORMATION

TO WRITE: Sharp Electronics Corporation
Customer Assistance Center
Sharp Plaza Blvd
Memphis, Tennessee 38193

TO ACCESS INTERNET: www.sharppusa.com

Please provide the following information when you write or call: model number, serial number, date of purchase, your complete mailing address (including zip code), your daytime telephone number (including area code) and description of the problem.

FOR CANADA

To obtain the name and address of the nearest Sharp Authorized Service Centre, please contact:

Sharp Electronics Of Canada Ltd.
335 Britannia Road East
Mississauga, Ontario
L4Z 1W9
(905) 568-7140

TO ACCESS INTERNET: www.sharpp.ca

Please provide the following information when you write or call: model number, serial number, date of purchase, your complete mailing address (including zip or postal code), your daytime telephone number (including area code) and description of the problem.

US CONSUMER LIMITED WARRANTY

SHARP ELECTRONICS CORPORATION (“SHARP”) warrants to the first consumer Purchaser that this SHARP brand product (the “Product”), when shipped in its original container, and sold or distributed in the United States by SHARP or an authorized SHARP dealer or reseller, will be free from defective workmanship and materials. SHARP agrees that it will, at its option, either repair the defect or replace the defective Product or part thereof with a new or remanufactured equivalent at no charge to the Purchaser for parts or labor for the period(s) set forth below.

This warranty does not apply to any appearance items of the Product nor to the additional excluded item(s) set forth below nor to any Product the exterior of which has been damaged or defaced, which has been subjected to misuse, abnormal service or handling, or which has been altered or modified in design or construction. This warranty does not apply if the microwave oven is not operated and maintained according to the instructions attached.

In order to enforce the rights under this limited warranty, the Purchaser should follow the steps set forth below and provide proof of purchase to the servicer.

The limited warranty described herein is in addition to whatever implied warranties may be granted to Purchasers by law. ALL IMPLIED WARRANTIES INCLUDING THE WARRANTIES OF MERCHANTABILITY AND FITNESS FOR USE ARE LIMITED TO THE PERIOD(S) FROM THE DATE OF PURCHASE SET FORTH BELOW. Some states do not allow limitations on how long an implied warranty lasts, so the above limitation may not apply to you. This limited warranty gives you specific legal rights, and you may also have other rights which vary from state to state.

Neither the sales personnel of the seller nor any other person is authorized to make any warranties other than those described herein, or to extend the duration of any warranties beyond the time period described above on behalf of SHARP.

The warranties described herein shall be the sole and exclusive warranties granted by SHARP and product repair or replacement shall be the sole and exclusive remedy available to the Purchaser. Correction of defects, in the manner and for the period of time described herein, shall constitute complete fulfillment of all liabilities and responsibilities of SHARP to the Purchaser with respect to the Product, and shall constitute full satisfaction of all claims, whether based on contract, negligence, strict liability or otherwise. In no event shall SHARP be liable, or in any way responsible, for any damages or defects in the Product which were caused by repairs or attempted repairs performed by anyone other than an authorized servicer. Nor shall SHARP be liable or in any way responsible for any incident or consequential economic or property damage. Some states do not allow the exclusion of incidental or consequential damages, so the above exclusion may not apply to you.

“THIS LIMITED WARRANTY IS VALID ONLY IN THE FIFTY (50) UNITED STATES, THE DISTRICT OF COLUMBIA, AND PUERTO RICO.”

Your product model number & description	SMC1585BB, SMC1585BS, SMC1585BW or Home Use Microwave. (Be sure to have this information available when you need service for your Product.)
Warranty period for this product:	One (1) year parts and labor including in-home service from the date of purchase. The warranty period continues for an additional four (4) years, for a total of five (5) years, with respect to the magnetron tube in the Product for parts only; labor and service are not included in the warranty, and will not provided free of charge for this additional period.
Additional item(s) excluded from warranty coverage (if any):	Non-functional accessories and light bulbs.
Where to obtain service:	From a SHARP Authorized Servicer located in the United States. To find the location of the nearest SHARP Authorized Servicer, call SHARP toll free at 1-800-BE-SHARP (1-800-237-4277).
What to do to obtain service:	For Products that are deemed to qualify for on-site service, a servicer will come to your location. If necessary the servicer may remove the unit for repair at the service facility and return it once completed. On-site service is not available in all areas and SHARP may, at our option, elect to provide transportation of the Product to and from an Authorized Service Center in those areas.

TO OBTAIN SUPPLY, ACCESSORY OR PRODUCT INFORMATION, CALL 1-800-BE-SHARP or visit www.sharppusa.com. SAVE THE PROOF OF PURCHASE AS IT IS NEEDED SHOULD YOUR OVEN EVER REQUIRE WARRANTY SERVICE.



LIMITED WARRANTY

Consumer Electronics Products

Congratulations on your purchase!

Sharp Electronics of Canada Ltd. ("Sharp") warrants to the first purchaser for this Sharp brand product ("Product"), when shipped in its original container and sold or distributed in Canada by Sharp or by an authorized Sharp dealer, and Product was not sold "as is" or "sales final" that the Product will during the applicable warranty period, be free from defects in material and workmanship, and will within the applicable warranty period, either repair the defective Product or provide the first purchaser a replacement of the defective Product.

Conditions: This limited warranty shall not apply to:

- (a) Any defects caused or repairs required as a result of abusive operation, negligence, accident, improper installation or inappropriate use as outlined in the owner's manual or other applicable Product documentation.
- (b) Any defects caused or repairs required as a result of any Product that has been tampered with, modified, adjusted or repaired by any person other than Sharp, a Sharp authorized service centre or a Sharp authorized servicing dealer.
- (c) Any defects caused or repairs required as a result of the use of the Product with items not specified or approved by Sharp, including but not limited to chemical cleaning agents.
- (d) Any replacement of accessories required through normal use of the Product, including but not limited to, remote controls, AC adapters, batteries, temperature probe, trays, filters, belts, ribbons, cables and paper.
- (e) Any cosmetic damage to the Product surface or exterior that has been defaced or caused by normal wear and tear.
- (f) Any defects caused or repairs required as a result of damage caused by any external or environmental conditions, including but not limited to, transmission line/power line voltage or liquid spillage or acts of God.
- (g) If the serial number or model number affixed to Product has been removed, defaced, changed, altered or tampered with.
- (h) This limited warranty will not apply if the Product has been used or is being used in a commercial setting or application; this warranty is meant solely for the non-commercial, household use of the Product by consumers in their home or residence.
- (i) Any installation, delivery, setup and/or programming charges
- (j) The removal and reinstallation of Over-The-Range Microwave, Microwave Drawer or Steam Oven if it is installed in an inaccessible location or requiring removal of cupboards, handles or other cosmetic parts, or is not installed in accordance with installation instructions included with Product.

How to get service: Warranty service may be obtained upon delivery of the Product, together with proof of purchase (including date of purchase) and a copy of this limited warranty statement, to an authorized Sharp service centre or an authorized Sharp servicing dealer. In home warranty service will be carried out to locations accessible by on-road service vehicle and within 50 km of an authorized Sharp service centre on any Over-The-Range Microwave Oven, Microwave Drawer Oven or Steam Oven. The servicer may if necessary take the unit for repair at the servicer's facility. No other person (including any Sharp dealer or service centre) is authorized to extend, enlarge or transfer this warranty on behalf of Sharp. The purchaser will be responsible for any and all removal, reinstallation, transportation and insurance costs incurred with exception for Over-The-Range Microwave Oven, Microwave Drawer Oven or Steam Oven whereby Sharp will be responsible for the removal and reinstallation.

The express warranties in this limited warranty are, except for consumer purchasers domiciled in Quebec, in lieu of and, except to the extent prohibited by applicable law, Sharp disclaims all other warranties and conditions, express or implied, whether arising by law, statute, by course of dealing or usage of trade, including, without limitation, implied warranties or conditions of merchantability and/or quality, fitness for a particular use or purpose, and/or non-infringement. **Limitations** (not applicable to consumer purchasers domiciled in Quebec to the extent prohibited under Quebec law): (a) Sharp shall not be liable for any incidental, special, consequential, economic, exemplary or indirect damages of any kind or nature (including lost profits or damages for loss of time or loss of use or loss of data) arising from or in any connection with the use or performance of a Product or a failure of a Product, even if Sharp is aware of or has been advised of the possibility of such damages; (b) the remedies described in this limited warranty constitute complete fulfillment of all obligations and responsibilities of Sharp to the purchaser with respect to the Product and shall constitute full satisfaction of all claims, whether based on contract, negligence, strict liability or otherwise. Some provinces may not allow the exclusion or limitation of certain damages, or limits on the duration or voiding of implied warranties or conditions; in such provinces, the exclusions and limits herein may not apply. This limited warranty is, except for consumer purchasers domiciled in Quebec, governed by the laws of the Province in Canada in which the purchaser has purchased the Product. For consumer purchasers domiciled in Quebec this limited warranty is governed by the laws of Quebec.

WARRANTY PERIODS (calculated from the date of original purchase): Parts & Labour (exceptions noted)

Microwave Oven	1 year	(magnetron - 4 additional years)
Steam Oven	1 year	
Small Kitchen Appliances	1 year	
Air Purifiers	1 year	

To obtain the name and address of the nearest Authorized Sharp Service Centre or Dealer, or for more information on this Limited Warranty, Sharp Extended Warranty Offers, Sharp Canada Products or Accessory Sales, please contact Sharp:

- By writing to Sharp Electronics Of Canada Ltd. at 335 Britannia Road East Mississauga, Ontario L4Z 1W9
- Calling: at 905-568-7140
- Visiting our Web site: www.sharp.ca

THIS LIMITED WARRANTY IS VALID ONLY IN CANADA

Revision: 03/21/2016

IMPORTANT SAFETY INSTRUCTIONS

READ ALL INSTRUCTIONS BEFORE USING

When using the appliance, basic safety precautions should be followed, including the following:

WARNING *To reduce the risk of burns, electric shock, fire, injury to persons or exposure to excessive microwave energy:*

- 1 Read all instructions before using the appliance.
- 2 Read and follow the specific “PRECAUTIONS TO AVOID POSSIBLE EXPOSURE TO EXCESSIVE MICROWAVE ENERGY” on page 2.
- 3 This appliance must be properly grounded. Connect only to properly grounded outlet. See “GROUNDING INSTRUCTIONS” on page 8.
- 4 Install or locate this appliance only in accordance with the provided installation instructions.
- 5 Some products such as whole eggs in shell and sealed containers - for example, closed glass jars—are able to explode and should not be heated in the appliance.
- 6 Use this appliance only for its intended use as described in this manual. Do not use corrosive chemicals or vapors in this appliance. This appliance is specifically designed to heat, cook or dry food. It is not designed for industrial or laboratory use.
- 7 As with any appliance, close supervision is necessary when used by children.
- 8 Do not operate this appliance if it has a damaged cord or plug, if it is not working properly or if it has been damaged or dropped.
- 9 This appliance should be serviced only by qualified service personnel. Contact nearest Sharp Authorized Servicer for examination, repair or adjustment.
- 10 Do not cover or block any openings on the appliance.
- 11 Do not store or use this appliance outdoors. Do not use this product near water—for example, near a kitchen sink, in a wet basement, near a swimming pool or similar locations.
- 12 Do not immerse cord or plug in water.
- 13 Keep cord away from heated surfaces.
- 14 Do not let cord hang over edge of table or counter.
- 15 See door surface cleaning instructions on page 31.
- 16 To reduce the risk of fire in the appliance cavity:
 - a Do not overcook food. Carefully attend appliance when paper, plastic or other combustible materials are placed inside the appliance to facilitate cooking.
 - b Remove wire twist-ties from paper or plastic bags before placing bag in appliance.
 - c If materials inside the appliance ignite, keep appliance door closed, turn microwave off and shut off power at the fuse or circuit breaker panel.
 - d Do not use the appliance for storage purposes. Do not leave paper products, cooking utensils, or food in the appliance when not in use.
- 17 Liquids, such as water, coffee or tea are able to be overheated beyond the boiling point without appearing to be boiling due to surface tension of the liquid. Visible bubbling or boiling when the container is removed from the appliance is not always present. **THIS COULD RESULT IN VERY HOT LIQUIDS SUDDENLY BOILING OVER WHEN A SPOON OR OTHER UTENSIL IS INSERTED INTO THE LIQUID.**

To reduce the risk of injury to persons:

 - a Do not overheat the liquid.
 - b Stir the liquid both before and halfway through heating it.
 - c Do not use straight-sided containers with narrow necks. Use a wide-mouthed container.
 - d After heating, allow the container to stand in the appliance at least for 20 seconds before removing the container.
 - e Use extreme care when inserting a spoon or other utensil into the container.
- 18 If the oven light fails, consult a SHARP AUTHORIZED SERVICER.
- 19 Do not operate any heating or cooking appliance beneath this appliance, except a properly installed electric wall oven or warming drawer.

SAVE THESE INSTRUCTIONS

IMPORTANT SAFETY INSTRUCTIONS

For USA, please go to www.sharppusa.com/trimkits to access the list of approved trim kits with these ovens. For Canada, please visit relevant product's page on www.sharp.ca for information on installation options and the list of approved trim kits.

- 20** Do not mount unit over or near any portion of a heating or cooking appliance, except a properly

installed electric wall oven or warming drawer. Go to www.sharppusa.com/trimkits to access the list of approved trim kits with these ovens.

- 21** Do not mount over a sink.
22 Do not store anything directly on top of the appliance surface when the appliance is in operation.

SAVE THESE INSTRUCTIONS

INSTALLATION INSTRUCTIONS

UNPACKING AND EXAMINING YOUR MICROWAVE OVEN

- 1** Remove all packing materials from inside the oven cavity. Read enclosures and SAVE the Operation Manual. DO NOT REMOVE AND THROW OUT THE WAVEGUIDE COVER.

- 2** Remove the feature sticker, if there is one.

Check the oven for any damage, such as misaligned or bent door, damaged door seals and sealing surfaces, broken or loose door hinges and latches and dents inside the cavity or on the door. If there is any damage, do not operate the oven and contact your dealer or SHARP AUTHORIZED SERVICER.

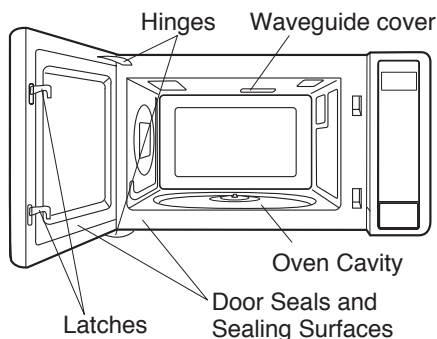

CHOOSING A LOCATION FOR YOUR OVEN

You will use your oven frequently so plan its location for ease of use. The oven must be placed on a countertop which is a minimum of 36 inches from the floor. Allow at least 2 inches on the sides, top and at the rear of the oven for air circulation. Be sure to position oven so that the rear cannot be touched inadvertently.

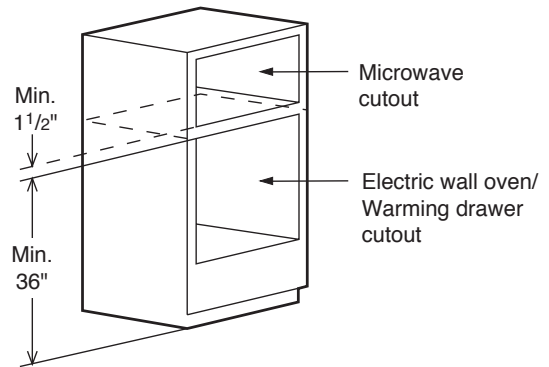

SKETCH 1

Your convection microwave oven can be built into a cabinet or wall by itself or above any electric wall oven or warming drawer. Go to www.sharppusa.com/trimkits (US customers only) to access the list of approved trim kits with these ovens.

Please visit relevant product's page on www.sharp.ca (Canada) for information on installation options and the list of approved trim kits.

See Sketch 1 for proper location when building in above an electric wall oven or a warming drawer. Carefully follow both the electric wall oven/warming drawer installation instructions and Sharp's Built-in Kit instructions. Be sure that the clearance of the floor between the electric wall oven/warming drawer and the microwave oven is minimum of 1 1/2 inches. The kit includes ducts and finish trim strips and easy-to-follow instructions for installation as well as the location of the power supply.

GROUNDING INSTRUCTIONS

This appliance must be grounded. This oven is equipped with a cord having a grounding wire with a grounding plug. It must be plugged into a wall receptacle that is properly installed and grounded in accordance with the National Electrical Code and local codes and ordinances. In the event of an electrical short circuit, grounding reduces the risk of electric shock by providing an escape wire for the electric current.

⚠ WARNING – Improper use of the grounding plug can result in a risk of electric shock.

ELECTRICAL REQUIREMENTS

The electrical requirements are a 120 volt 60 Hz, AC only, 15 amp. or more protected electrical supply. It is recommended that a separate circuit serving only the microwave oven be provided.

The oven is equipped with a 3-prong grounding plug. It must be plugged into a wall receptacle that is properly installed and grounded. Should you only have a 2-prong outlet, have a qualified electrician install a correct wall receptacle.

A 3-prong adapter may be purchased and used temporarily if local codes allow. Follow package directions.

A short power-supply cord is provided to reduce risk of becoming entangled in or tripping over a longer cord.

EXTENSION CORD

If it is necessary to use an extension cord, use only a 3-wire extension cord that has a 3-blade grounding plug and a 3-slot receptacle that will accept the plug on the microwave oven. The marked rating of the extension cord should be AC 115-120 volt, 15 amp. or more.

Be careful not to drape the cord over the countertop or table where it can be pulled on by children or tripped over accidentally.

Note:

1. If you have any questions about the grounding or electrical instructions, consult a qualified electrician or service person.
2. Neither Sharp nor the dealer can accept any liability for damage to the oven or personal injury resulting from failure to observe the correct electrical connection procedures.

RADIO OR TV INTERFERENCE

Should there be any interference caused by the microwave oven to your radio or TV, check that the microwave oven is on a different electrical circuit, relocate the radio or TV as far away from the oven as feasible or check position and signal of receiving antenna.

Permanent and Correct Installation

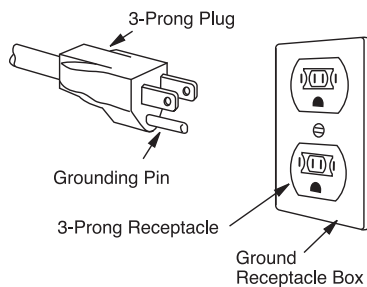

Temporary Use

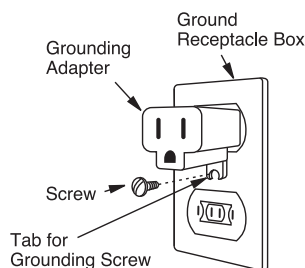

INFORMATION YOU NEED TO KNOW

ABOUT YOUR MICROWAVE OVEN

This operation manual is valuable: read it carefully and always save it for reference.

NEVER use the microwave oven without the turntable and support nor turn the turntable over so that a large dish could be placed in the microwave oven. The turntable will turn both clockwise and counterclockwise.

ALWAYS have food in the microwave oven when it is on to absorb the microwave energy.

When using the oven at power levels below 100%, you may hear the magnetron cycling on and off. It is normal for the exterior of the oven to be warm to the touch when cooking or reheating.

Condensation is a normal part of microwave cooking. Room humidity and the moisture in food will influence the amount of moisture that condenses in the oven. Generally, covered foods will not cause as much condensation as uncovered ones. Vents on the oven back must not be blocked.

After using convection, automatic mix or broil, you will hear the sound of the cooling fan. The fan may continue to operate as long as 5 minutes, depending on the oven temperature.

Be aware that, unlike microwave-only ovens, convection microwave ovens have a tendency to become hot during convection, automatic mix and broil cooking.

The oven is for food preparation only. It should not be used to dry clothes or newspapers.

Your microwave output is rated 900 watts using the IEC Test Procedure. In using recipes or package directions, check food at the minimum time and add time accordingly.

ABOUT MICROWAVE COOKING

- Arrange food carefully. Place thickest areas towards outside of dish.
- Watch cooking time. Cook for the shortest amount of time indicated and add more as needed. Food severely overcooked can smoke or ignite.
- Cover foods while cooking. Check recipe or cookbook for suggestions: paper towels, wax paper, microwave plastic wrap or a lid. Covers prevent spattering and help foods to cook evenly.
- Shield with small flat pieces of aluminum foil any thin areas of meat or poultry to prevent overcooking before dense, thick areas are cooked thoroughly.
- Stir foods from outside to center of dish once or twice during cooking, if possible.
- Turn foods over once during microwaving to speed cooking of such foods as chicken and hamburgers.

Large items like roasts must be turned over at least once.

- Rearrange foods such as meatballs halfway through cooking both from top to bottom and from right to left.
- Add standing time. Remove food from microwave oven and stir, if possible. Cover for standing time which allows the food to finish cooking without overcooking.
- Check for doneness. Look for signs indicating that cooking temperatures have been reached.

Doneness signs include:

- Food steams throughout, not just at edge.
- Center bottom of dish is very hot to the touch.
- Poultry thigh joints move easily.
- Meat and poultry show no pinkness.
- Fish is opaque and flakes easily with a fork.

ABOUT SAFETY

- Check foods to see that they are cooked to the United States Department of Agriculture's recommended temperatures.

145°F - Fish.

160°F - Pork, ground beef/veal/lamb, egg dishes

165°F - For leftover, ready-to-reheat refrigerated, and deli and carry-out "fresh" food. Whole, pieces and ground turkey/chicken/duck.

To test for doneness, insert a meat thermometer in a thick or dense area away from fat or bone. **NEVER** leave the thermometer in the food during cooking, unless it is approved for microwave use.

- **ALWAYS** use potholders to prevent burns when handling utensils that are in contact with hot food. Enough heat from the food can transfer through utensils to cause skin burns.
- Avoid steam burns by directing steam away from the face and hands. Slowly lift the farthest edge of a dish's covering and carefully open popcorn and oven cooking bags away from the face.
- Stay near the microwave oven while it's in use and check cooking progress frequently so that there is no chance of overcooking food.
- **NEVER** use the microwave oven for storing cookbooks or other items.
- Select, store and handle food carefully to preserve its high quality and minimize the spread of foodborne bacteria.
- Keep waveguide cover clean. Food residue can cause arcing and/or fires. See page 31.

INFORMATION YOU NEED TO KNOW

ABOUT CHILDREN AND THE MICROWAVE

Children below the age of 7 should use the microwave oven with a supervising person very near to them. Between the ages of 7 and 12, the supervising person should be in the same room. The child must be able to reach the microwave oven comfortably.

At no time should anyone be allowed to lean or swing on the microwave oven.

Children should be taught all safety precautions: use potholders, remove coverings carefully, pay special attention to packages that crisp food because they may be extra hot.

Don't assume that because a child has mastered one cooking skill he/she can cook everything.

Children need to learn that the microwave oven is not a toy. See page 29 for Safety Lock feature.

ABOUT FOODS

FOOD	DO	DON'T
Eggs, sausages, fruits & vegetables	<ul style="list-style-type: none"> • Puncture egg yolks before cooking to prevent "explosion". • Pierce skins of potatoes, apples, squash, hot dogs and sausages so that steam escapes. 	<ul style="list-style-type: none"> • Cook eggs in shells. • REHEAT whole eggs. • Dry nuts or seeds in shells.
Popcorn	<ul style="list-style-type: none"> • Use specially bagged popcorn for the microwave. • Listen while popping corn for the popping to slow to 1 or 2 seconds or use special POPCORN pad. 	<ul style="list-style-type: none"> • Pop popcorn in regular brown bags or glass bowls. • Exceed maximum time on popcorn package.
Baby food	<ul style="list-style-type: none"> • Transfer baby food to small dish and heat carefully, stirring often. Check temperature before serving. • Put nipples on bottles after heating and shake thoroughly. "Wrist" test before feeding. 	<ul style="list-style-type: none"> • Heat disposable bottles. • Heat bottles with nipples on. • Heat baby food in original jars.
General	<ul style="list-style-type: none"> • Cut baked goods with filling after heating to release steam and avoid burns. • Stir liquids briskly before and after heating to avoid "eruption". • Use deep bowl, when cooking liquids or cereals, to prevent boilovers. 	<ul style="list-style-type: none"> • Heat or cook in closed glass jars or airtight containers. • Heat can in the microwave as harmful bacteria may not be destroyed. • Deep fat fry. • Dry wood, gourds, herbs or wet papers.

INFORMATION YOU NEED TO KNOW

ABOUT UTENSILS AND COVERINGS

It is not necessary to buy all new cookware. Many pieces already in your kitchen can be used successfully in your new convection microwave oven. The chart below will help you decide what utensils and coverings should be used in each mode.

UTENSILS AND COVERINGS	MICROWAVE ONLY	CONVECTION BROIL, SLOW COOK	HIGH MIX/ ROAST LOW MIX/BAKE
Aluminum foil	YES. Small flat pieces of aluminum foil placed smoothly on food can be used to shield areas from cooking or defrosting too quickly. Keep foil at least 1 inch from walls of oven.	YES. For shielding	YES. For shielding
Aluminum containers	YES. Can be used if 3/4 filled with food. Keep 1 inch away from walls and do not cover with foil.	YES. Broil-No cover	YES. Can be used if 3/4 filled with food. Keep 1 inch away from walls and do not cover with foil.
Browning dish	YES. Do not exceed recommended preheating time. Follow manufacturer's directions.	NO	NO
Glass ceramic (Pyroceram®)	YES. Excellent	YES. Excellent	YES. Excellent
Glass, heat-resistant	YES. Excellent.	YES. Excellent	YES. Excellent
Glass, non-heat-resistant	NO	NO	NO
Lids, glass	YES	YES. Broil-No cover	YES
Lids, metal	NO	YES. Broil-No cover	NO
Metal cookware	NO	YES	YES. Do not use metal covering.
Metal, misc: dishes with metallic trim, screws, bands, handles. Metal twist ties	NO	NO	NO
Oven cooking bags	YES. Good for large meats or foods that need tenderizing. DO NOT use metal twist ties.	YES. Broil-No cover	YES. Do not use metal twist ties.
Paper plates	YES. For reheating.	NO	NO
Paper towels	YES. To cover for reheating and cooking. Do not use recycled paper towels which may contain metal fillings.	NO	NO
Paper, ovenable	YES	YES. For temperatures up to 400°F. Do not use for broiling.	YES. For temperatures up to 400°F.
Microwave-safe plastic containers	YES. Use for reheating and defrosting. Some microwave-safe plastics are not suitable for cooking foods with high fat and sugar content. Follow manufacturer's directions.	NO	NO

INFORMATION YOU NEED TO KNOW

UTENSILS AND COVERINGS	MICROWAVE ONLY	CONVECTION BROIL, SLOW COOK	HIGH MIX/ ROAST LOW MIX/BAKE
Plastic, Thermoset®	YES	YES. Are heat resistant up to 425°F. Do not use for broiling.	YES
Plastic wrap	YES. Use brands specially marked for microwave use. DO NOT allow plastic wrap to touch food. Vent so steam can escape.	NO	NO
Pottery, porcelain stoneware	YES. Check manufacturer's recommendation for being microwave safe.	YES	YES. Must be microwave safe AND ovenable.
Styrofoam	YES. For reheating.	NO	NO
Wax paper	YES. Good covering for cooking and reheating.	NO	NO
Wicker, wood, straw	YES. May be used for short periods of time. Do not use with high fat or high sugar content foods. Could char.	NO	NO

DISH CHECK: If you wish to check if a dish is safe for microwaving, place the empty dish in the oven and microwave on HIGH for 30 seconds. If the dish becomes very hot, do NOT use it for microwaving.

ACCESSORIES: There are many microwave accessories available for purchase. Evaluate carefully before you purchase so that they meet your needs. A microwave-safe thermometer will assist you in determining correct doneness and assure you that foods have been cooked to safe temperatures when using microwave-only cooking. Sharp is not responsible for any damage to the oven when accessories are used.

MICROWAVE OVEN

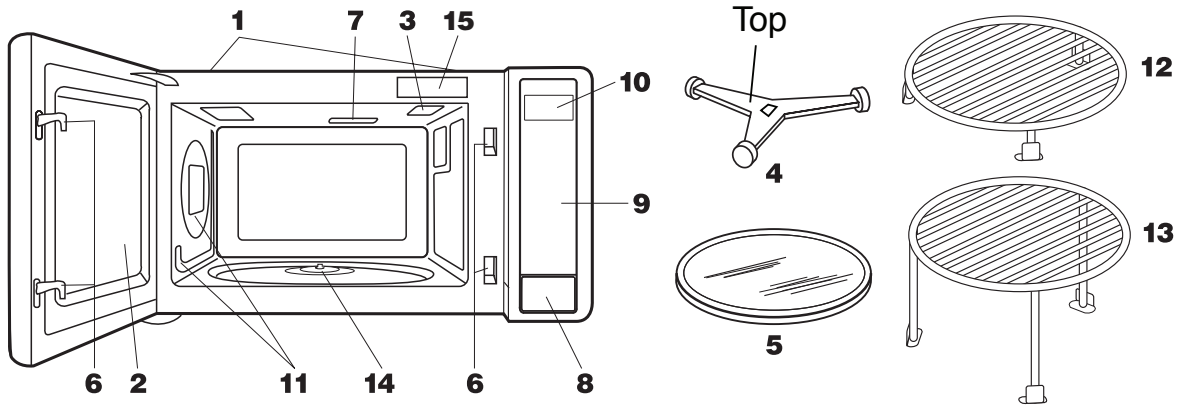

- 1 Ventilation openings (Rear side)
- 2 Oven door with see-through window
- 3 Oven light: It will light when the door is opened or when oven is in operation.
- 4 Turntable support
- 5 Removable turntable: The turntable will rotate clockwise or counterclockwise.
- 6 Safety door latches: The oven will not operate unless the door is securely closed.
- 7 Waveguide cover: DO NOT REMOVE.
- 8 Door open button
- 9 Auto-Touch control panel
- 10 Lighted digital display
- 11 Convection air openings
- 12 Removable low rack (Broiling rack)
- 13 Removable high rack (Baking rack)
- 14 Turntable motor shaft
- 15 Menu Label

MENU LABEL

AUTO DEFROST	AUTO BROIL	AUTO ROAST	AUTO BAKE
1. Ground Meat	1. Hamburgers	1. Chicken	1. Bundt Cake
2. Steaks	2. Chicken Pieces	2. Turkey	2. Cookies
3. Chicken Pieces	3. Steaks	3. Turkey Breast	3. Muffins
	4. Fish Steaks	4. Pork	4. French Fries

ACCESSORIES

The following accessories are designed especially for use in this oven only for convection, mix or broil cooking. **DO NOT USE FOR MICROWAVE ONLY COOKING.** Do not substitute similar types of racks for these specially designed ones.

High rack (Baking rack)—for convection and low mix.

- This rack is placed on the turntable for two-level cooking, such as layer cakes, muffins, etc.

Low rack (Broiling rack)—for convection, broiling or high mix.

- Place on the turntable and use for roasting or broiling to allow juices to drain away from food.

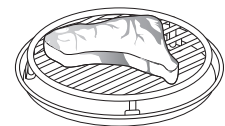
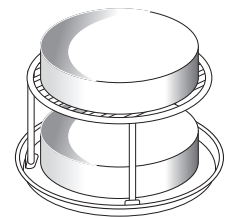

For US: please visit www.sharpsusa.com and search for the model number to download Sharp's CONVECTION MICROWAVE COOKBOOK.

For Canada: please visit relevant product's page on www.sharp.ca to download Sharp's CONVECTION MICROWAVE COOKBOOK.

BEFORE OPERATING

Before operating your new microwave oven make sure you read and understand this operation manual completely.

- Before the oven can be used, follow these steps:
 - 1 Plug in the oven. **WELCOME** **PRESS** **CLEAR** **AND** **PRESS** **CLOCK** will appear.
 - 2 Touch the **STOP/CLEAR** pad. **:** will appear.
 - 3 Touch **CLOCK** pad.

TO SET THE CLOCK

- 1 Touch **CLOCK** pad.
- 2 Touch number pads for correct time of day and touch **CLOCK** pad again.

This is a 12 hour clock. If you attempt to enter an incorrect clock time, **ERROR** will appear in the display. Touch the **STOP/CLEAR** pad and re-enter the time.

- If the electrical power supply to your microwave oven

should be interrupted, the display will intermittently show **WELCOME** **PRESS** **CLEAR** **AND** **PRESS** **CLOCK** after the power is reinstated. If this occurs during cooking, the program will be erased. The time of day will also be erased. Simply touch **STOP/CLEAR** pad and reset the clock for the correct time of day.

STOP/CLEAR

Touch the **STOP/CLEAR** pad to:

- 1 Erase if you make a mistake during programming.
- 2 Cancel timer.
- 3 Stop the oven temporarily during timed cooking.
- 4 Return the time of day to the display.
- 5 Cancel a program during cooking, touch twice.

MANUAL OPERATION

TIME COOKING

Your microwave oven can be programmed for 99 minutes 99 seconds (99.99). Always enter the seconds after the minutes, even if they are both zeros.

- For example, to cook for 5 minutes at 100%.
 - 1 Enter cooking time by touching the number pads **5** **0** **0**.
 - 2 Touch **START/TOUCH ON** pad.

TO SET POWER LEVEL

The microwave has 11 preset power levels.

Using lower power levels increases the cooking time which is recommended for foods such as cheese, milk and, long slow cooking of meats or defrosting. Consult a cookbook or recipes for specific recommendations.

- For example, to defrost for 5 minutes at 30%.
 - 1 Enter defrost time **5** **0** **0**.
 - 2 Touch **POWER LEVEL** pad and number **3**.
 - 3 Touch **START/TOUCH ON** pad.

You can program up to 4 automatic cooking sequences. Follow directions on page 30. Note that the power level must be entered first when programming multiple sequences.

TOUCH POWER LEVEL PAD ONCE THEN TOUCH	APPROXIMATE PERCENTAGE OF POWER	COMMON WORDS FOR POWER LEVELS
POWER LEVEL	100%	High
9	90%	
8	80%	
7	70%	Medium High
6	60%	
5	50%	Medium
4	40%	
3	30%	Med Low/ Defrost
2	20%	
1	10%	Low
0	0%	

MICROWAVE FEATURES

AUTO DEFROST

Auto Defrost automatically defrosts foods shown in the Auto Defrost Chart.

- For example, to defrost a 2.0 pound steak:
 - 1 Touch the **AUTO DEFROST** pad once.
 - 2 Select the desired food by touching the **AUTO DEFROST** pad until the display shows the food name. Ex. touch twice for steak.
 - 3 Enter the weight by touching the number pads **2|0|**.
 - 4 Touch the **START/TOUCH ON** pad.The oven will stop and directions will be displayed. Follow the indicated message.
 - 5 After the 1st stage, open the door. Turn the steak over and shield any warm portions. Close the door. Touch the **START/TOUCH ON** pad.

- 6 After the 2nd stage, open the door. Shield any warm portions. Close the door. Touch the **START/TOUCH ON** pad.

After the defrost cycle ends, cover and let stand as indicated in chart below.

Note:

- If you attempt to enter more or less than the allowed amount as indicated in the chart, an error message will appear in the display.
- Auto Defrost can be programmed with More or Less Time Adjustment. See page 30.
- To defrost other foods or foods above or below the weights allowed on the Auto Defrost Chart, see Manual Defrost below.

AUTO DEFROST CHART

FOOD	AMOUNT	PROCEDURE
1 Ground meat	.5 - 3.0 lb.	Remove any thawed pieces after each stage. Let stand, covered, for 5 to 10 minutes.
2 Steaks (Chops, fish)	.5 - 4.0 lb.	After each stage of defrost cycle, rearrange and if there are warm or thawed portions, shield with small flat pieces of aluminum foil. Remove any meat or fish that is nearly defrosted. Let stand, covered, 10–20 minutes.
3 Chicken pieces	.5 - 3.0 lb.	After each stage of defrost cycle, if there are warm or thawed portions, rearrange or remove. Let stand, covered, 10–20 minutes.

MANUAL DEFROST

If the food that you wish to defrost is not listed on the Auto Defrost Chart or is above or below the limits in the AMOUNT column on the Auto Defrost Chart, you need to defrost manually.

You can defrost any frozen food, either raw or previously cooked, by setting the Power Level to 30%. Follow the exact 3-step procedure found under To Set Power Level on page 15. Estimate the defrosting time and press **3|** for 30% when you select the power level.

For either raw or previously cooked frozen food, the rule of thumb is approximately 5 minutes per pound.

For example, defrost 5 minutes for 1 pound of frozen spaghetti sauce.

Always stop the oven periodically to remove or separate the portions that are defrosted. If food is not defrosted at the end of the estimated defrosting time, program the oven in 1 minute increments on Power Level 3 until totally defrosted.

When using plastic containers from the freezer, defrost only long enough to remove from the plastic in order to place in a microwave-safe dish.

SENSOR COOKING

Sharp's Sensor is a semi-conductor device that detects the vapor (moisture and humidity) emitted from the food as it heats. The sensor adjusts the cooking times and power levels for various foods and quantities.

USING SENSOR SETTINGS:

- 1 After the oven is plugged in, wait 2 minutes before using any Sensor setting.
- 2 Be sure the exterior of the cooking container and the interior of the microwave oven are dry. Wipe off any moisture with a dry cloth or paper towel.
- 3 Reheat and Popcorn can only be entered within 1 minute after cooking, opening and closing the door or touching the **STOP/CLEAR** pad.
- 4 During the first part of sensor cooking, the food name will appear on the display. Do not open the oven door or touch **STOP/CLEAR** during this part of the cooking cycle. The measurement of vapor will be interrupted. If this occurs, an error message will appear. To continue cooking, touch the **STOP/CLEAR** pad and select cooking time and variable power.

When the sensor detects the vapor emitted from the food, remainder of cooking time will appear. Door may be opened when remaining cooking time appears on the display. At this time, you may stir or season food, as desired.

- 5 Check food for temperature after cooking. If additional time is needed, continue to cook with variable power and time.
- 6 If the sensor does not detect vapor properly when popping popcorn, the oven will turn off, and the correct time of day will be displayed. If the sensor does not detect vapor properly when using sensor reheat, **ERROR** will be displayed, and the oven will turn off.
- 7 Any Sensor Cooking mode can be programmed with More or Less Time Adjustment. See page 30.
- 8 Each food has a cooking hint. Touch **HELP/SETTINGS** when the HELP indicator is lighted in the display.

SELECTING FOODS:

- 1 The sensor works with foods at normal storage temperature. For example, food for dinner plate reheat would be at refrigerator temperature and popcorn at room temperature.
- 2 Foods weighing less than 3 ounces should be reheated by time and variable power.

COVERING FOODS:

Some foods work best when covered. Use the cover recommended in the charts for these foods.

- 1 Casserole lid.
- 2 Plastic wrap: Use plastic wrap recommended for microwave cooking. Cover dish loosely; allow approximately 1/2 inch to remain uncovered to allow steam to escape. Plastic wrap should not touch food.
- 3 Wax paper: Cover dish completely; fold excess wrap under dish to secure. If dish is wider than paper, overlap two pieces at least one inch to cover.

Be careful when removing any covering to allow steam to escape away from you.

MICROWAVE OVEN COOKING

REHEAT

You can reheat many foods by touching just one pad. You don't need to calculate reheating time or power level.

- For example, to heat prepared chili:

Touch the **REHEAT** pad.

When the Sensor detects the vapor emitted from the food, the remainder of reheating time will appear.

POPCORN

- For example, to pop a 3.5 oz. bag of popcorn:

Touch the **POPCORN** pad once.

This Sensor setting works well with most brands of microwave popcorn. You may wish to try several and choose your favorite. Pop only one bag at a time. Unfold the bag and place in oven according to directions.

REHEAT / POPCORN CHART

FOOD	AMOUNT	PROCEDURE
Reheat		
Leftovers such as rice, potatoes, vegetables, casserole	4 - 36 oz.	Place in dish or casserole slightly larger than amount to reheat. Flatten, if possible. Cover with lid, plastic wrap or wax paper. Use covers such as plastic wrap or lids with larger quantities of more dense foods such as stews.
Soups	1 - 4 cups	After reheating, stir well, if possible. Foods should be very hot. If not, continue to heat with variable power and time. After stirring, recover and allow to stand 2 to 3 minutes.
Canned entrees and vegetables	4 - 36 oz.	Use Less Time Adjustment by touching POWER LEVEL pad twice for small quantities of canned vegetables.
Popcorn		
	Only 1 package at a time	Use only popcorn packaged for microwave oven use. Try several brands to decide which you like best. Do not try to pop unpopped kernels. More Or Less Time Adjustment can be used to provide adjustment needed for older popcorn or individual tastes.
	3.0 - 3.5 oz. bag (Regular size)	Touch POPCORN pad once. This setting works well with most 3.0-3.5 oz. bags of microwave popcorn.
	1.5 - 1.75 oz. bag (Snack size)	Touch POPCORN pad twice within 2 seconds for snack size bags.

MICROWAVE OVEN COOKING

SENSOR MENU

- For example, to cook a baked potato:
 - 1 Touch the **SENSOR MENU** pad.
 - 2 Select the desired sensor setting. Ex: touch the number pad **1** to cook baked potatoes.
 - 3 Touch the **START/TOUCH ON** pad.

When Sensor detects the vapor emitted from the food, the remainder of cooking time will appear.

SENSOR MENU CHART

FOOD	AMOUNT	PROCEDURE
1 POTATOES	1 - 8 med.	Pierce. Place on paper-towel-lined microwave oven. After cooking, remove from microwave, wrap in aluminum foil and let stand 5 to 10 minutes.
2 FROZEN VEG	1 - 8 cups	Do not add water. Cover with lid or plastic wrap. After cooking, stir, and let stand covered for 3 minutes.
3 SOFT VEG		Wash and place in casserole. Do not add water if vegetables have just been washed. Cover with lid for tender vegetables. Use plastic wrap for tender-crisp vegetables. After cooking, stir, if possible. Let stand covered for 2 to 5 minutes.
Broccoli	.25 - 2.0 lb.	
Brussel sprouts	.25 - 2.0 lb.	
Cabbage	.25 - 2.0 lb.	
Cauliflower (flowerets)	.25 - 2.0 lb.	
Cauliflower (whole)	1 med.	
Spinach	.25 - 1.0 lb.	
Zucchini	.25 - 2.0 lb.	
Baked apples	2 - 4 med.	
4 HARD VEG		Place in casserole. Add 1 - 4 tablespoons water. Cover with lid for tender vegetables. Use plastic wrap cover for tender-crisp vegetables. After cooking, stir, if possible. Let stand covered for 2 to 5 minutes.
Carrots, sliced	.25 - 1.5 lb.	
Corn on the cob	2 - 4 pcs.	
Green beans	.25 - 1.5 lb.	
Winter squash:		
diced	.25 - 1.5 lb.	
halves	1 - 2	
5 ENTRÉES	6 - 17 oz.	Use for frozen convenience foods. It will give satisfactory results for most brands. You may wish to try several and choose your favorite. Remove package from outer wrapping and follow package directions for covering. After cooking, let stand covered for 1 to 3 minutes.
6 HOT DOGS	1 - 4 servings	Place hot dog in bun and wrap in paper towel or paper napkin.
7 BACON	2 - 6 slices	Place bacon on paper plate lined with paper towel. Bacon should not extend over the rim of plate. Cover with paper towel. Put another paper plate upside down on turntable. Place plate of bacon on top of overturned plate.
8 FISH	.25 - 2.0 lb.	Arrange in ring around shallow glass dish (roll fillet with edges underneath). Cover with vented plastic wrap. After cooking, let stand covered for 3 minutes.

CONVECTION AUTOMATIC OPERATION

This section of the operation manual offers instructions for preparing 12 popular foods using Auto Broil, Auto Roast and Auto Bake.

After selecting the desired feature, follow the directions indicated in the display.

For helpful hints, simply touch **HELP SETTINGS** anytime **HELP** is lighted in the display.

CAUTION The oven cabinet, cavity, door, turntable, turntable support, racks and dishes will become hot. To **PREVENT BURNS**, use thick oven gloves when removing the food or turntable from the oven.

AUTO BROIL

Auto Broil automatically broils hamburgers, chicken pieces, steaks and fish steaks.

- For example, to broil 2 hamburgers:

- 1 Touch the **AUTO BROIL** pad.
- 2 Select the desired setting. Ex: for hamburgers, touch number pad **1**.
- 3 Touch the number pad to enter quantity. Ex: **2**. Follow the information in display for cooking information.

For well done or rare burgers, touch the **POWER LEVEL** pad to select More for well done or Less for rare. See More Or Less Time Adjustment on page 30.

- 4 Touch the **START/TOUCH ON** pad.

After the broil preheat cycle ends, the oven will stop and directions will be displayed. Follow the indicated message. Open the door and place hamburgers into oven. Close the door.

- 5 Touch **START/TOUCH ON** pad.

Note:

- Auto Broil can be programmed with More Or Less Time Adjustment. See page 30.
- If you attempt to enter more or less than the allowed amount as indicated in chart below, an error message will appear in the display.
- To broil other foods or foods above or below the weight or number allowed on Auto Broil Chart, follow the instructions in the Convection Broiling Chart on page 21.

AUTO BROIL CHART

SETTING/FOOD	AMOUNT	RACK	PROCEDURE
1 Hamburgers	1 - 8 pieces 0.25 lb each	Low	Use this setting to broil hamburger patties. Place on low rack.
2 Chicken pieces	0.5 - 3.5 lb.	Low	Arrange pieces on low rack. After cooking, let stand 3-5 minutes. Dark meat should be 180°F, and white meat should be 170°F.
3 Steaks	0.5 - 2.0 lb.	Low	Use this setting to broil steaks from 3/4" to 1" thick. Individual boneless steaks broil evenly. Place steak on low rack. For well done, touch Power Level once; for rare, touch POWER LEVEL twice.
4 Fish steaks	0.5 - 2.0 lb.	Low	Use this setting to broil fish steak, which is 3/4" to 1" thick. Place on low rack.

CONVECTION AUTOMATIC OPERATION

CONVECTION BROILING CHART

CUT		WEIGHT/ THICKNESS	CONVECTION TIME	
Beef				
Rib		3/4-1 in. 7-8 oz. each	Rare	10-13 min.
			Medium	14-16 min.
			Well Done	17-20 min.
Steaks: Sirloin, Porterhouse, T-Bone		1-1 1/2 in.	Rare	10-13 min.
			Medium	14-18 min.
			Well Done	19-25 min.
Chuck Steak		1 in.	Rare	12-14 min.
			Medium	15-18 min.
			Well Done	19-23 min.
London Broil		1-1 1/4 in. 2 1/2 -3 lb.	Rare	23-25 min.
			Medium	26-30 min.
Hamburgers		1/4 lb. each	Medium	13-15 min.
			Well Done	18-20 min.
Pork				
Chops: loin or center		3/4-1 in.	Well Done	16-20 min.
Bacon		Regular sliced		4-5 min.
		Thick sliced		7-8 min.
Sausage:	Brown 'n Serve	Patties: 1/2 in., 8 oz.-1 lb.		8-10 min.
	Fresh	Links: 8 oz.-1 lb.		8-10 min.
Ham slice, fully cooked		3/4 in.		10-12 min.
Frankfurters		1 lb.		5-7 min.
Lamb				
Chops: rib, loin or center		3/4 in. 3-4 oz. each	Medium	12-14 min.
			Well Done	15-17 min.
Chicken				
Broiler-Fryer, halved, quartered or cut up		1-3 lb.		25-35 min.
Fish				
Fillets		1/4 - 3/4 in.		6-7 min.
Steaks		3/4-1 in.		12-14 min.

CONVECTION AUTOMATIC OPERATION

AUTO ROAST

Auto Roast automatically roasts chicken, turkey, turkey breast or pork.

- For example, to roast a 2.5 pound chicken:
 - 1 Touch the **AUTO ROAST** pad.
 - 2 Select the desired setting. Ex: for chicken, touch the number pad **1**.
 - 3 Touch the number pad to enter the weight. Ex: 2.5 lb. **2|5**
 - 4 Touch the **START/TOUCH ON** pad.

After the Auto Roast cycle ends, a long tone will sound. Follow the indicated message.

Note:

- Auto Roast can be programmed with the More Or Less Time Adjustment. See page 30.
- If you attempt to enter more or less than the allowed weight as indicated in chart below, an error message will appear in the display.
- To roast other food or foods above or below the weights allowed on Auto Roast Chart, check the Combination Roasting Chart on page 23.

AUTO ROAST CHART

SETTING/FOOD	AMOUNT	RACK	PROCEDURE
1 Chicken	2.5 - 7.5 lb.	Low	After the cycle ends, cover with foil and let stand for 5 to 10 minutes.
2 Turkey	6.5 - 16.0 lb.	Low	Season as desired. Place on low rack. After the cycle ends, cover with foil and let stand 10 minutes. Internal temperature of white meat should be 170°F and dark meat, 180°F.
3 Turkey breast	3.0 - 6.0 lb.	Low	Season as desired. Place on low rack. After the cycle ends, cover with foil and let stand 10 minutes. Internal temperature of white meat should be 170°F.
4 Pork	2.0 - 3.5 lb.	Low	Boneless pork loin is recommended because it cooks evenly. Place on a low rack. After cooking, remove from oven, cover with foil and allow to stand 5 to 10 minutes. Internal temperature should be 165°F.

CONVECTION AUTOMATIC OPERATION

COMBINATION ROASTING CHART

CUT		TIME
Beef		
Roasts (tender cuts)	Rare	12-14 min. per lb. at HIGH MIX, 325°F
	Medium	13-15 min. per lb. at HIGH MIX, 325°F
	Well Done	14-17 min. per lb. at HIGH MIX, 325°F
Roasts (less tender cuts)	Rare	12-15 min. per lb. at HIGH MIX, 325°F
	Medium	13-17 min. per lb. HIGH MIX, 325°F
	Well Done	14-18 min. per lb. at HIGH MIX, 325°F
Veal		
Roasts (boned, rolled, tied)	Well Done	14-16 min. per lb. at HIGH MIX, 325°F
Breast (stuffed)	Well Done	11-13 min. per lb. at HIGH MIX, 325°F
Pork		
Roasts (boned, rolled, tied or bone-in)	Well Done	14-16 min. per lb. at HIGH MIX, 325°F
Smoked Ham		7-9 min. per lb. at HIGH MIX, 325°F
Lamb		
Leg, Roasts	Rare	10-12 min. per lb. at HIGH MIX, 325°F
	Medium	12-14 min. per lb. at HIGH MIX, 325°F
	Well Done	14-16 min. per lb. at HIGH MIX, 325°F
Poultry		
Chicken, whole		9-13 min. per lb. at HIGH MIX, 325°F
Chicken, pieces		10-14 min. per lb. at HIGH MIX, 375°F
Turkey (unstuffed)		7-10 min. per lb. at HIGH MIX, 325°F
Turkey Breast		13-16 min. per lb. at HIGH MIX, 325°F

CONVECTION AUTOMATIC OPERATION

AUTO BAKE

Auto Bake automatically bakes cakes, brownies, muffins and french fries.

- For example, to bake a bundt cake:

- 1 Touch the **AUTO BAKE** pad.
- 2 Select the desired setting. Ex: for bundt cake, touch the number pad **1**.
- 3 Touch the **START/TOUCH ON** pad.

Note:

- Auto Bake can be programmed with the More Or Less Time Adjustment. See page 30.
- To bake other foods, see the Combination Baking Chart on page 25.

AUTO BAKE CHART

SETTING/FOOD	AMOUNT	RACK	PROCEDURE
1 Bundt cake	1 cake	No rack	Ideal for packaged cake mix or your own recipe. Prepare according to package or recipe directions and place in a greased and floured bundt pan. Place pan in oven. Cool before frosting and serving.
2 Cookies	1 or 2 pizza pans	1 pizza pan No rack 2 pizza pans High	Ideal for refrigerated cookie dough. Prepare according to package or recipe directions and place on a greased and floured 12" pizza pan. Cookies should be approximately 1/3 inch thick and 2 inches in diameter for best results. After the preheat is over, place pan in oven. Cool before serving
3 Muffins	6 - 12 muffins 1 or 2 muffin pans	1 pan No rack 2 pans High	Ideal for packaged muffin mix or your own recipe for 6-12 medium size muffins. Prepare according to package or recipe directions and place in muffin pan. After the preheat is over, place pan in oven.
4 French fries	3 - 24 oz. 1 or 2 pizza pans For more than 12 oz. use 2 pans	1 pizza pan No rack 2 pizza pans High	Use frozen prepared french fries. No preheat is required for the french fries baking procedure. Place french fries on pizza pan. For shoestring potatoes, touch POWER LEVEL pad twice to enter less time before touching START/TOUCH ON pad.

CONVECTION AUTOMATIC OPERATION

COMBINATION BAKING CHART

ITEM	PROCEDURE
Cakes: Your recipe or mix	
Tube or Bundt Cakes	LOW MIX, 350°F for three-fourths the recommended time.
Angel Food	LOW MIX, 350°F for 25 to 30 minutes.
Loaf Cakes or Quick Breads	LOW MIX, 350°F for three-fourths the recommended time.
Bar Cookies: Your recipe or mix	LOW MIX, 350°F for three-fourths the recommended time or until wooden pick inserted in center comes out clean.
Pies	
Single Crust: Baked before filling, your recipe, mix or frozen prepared	Prick crust with fork. Preheat oven to 425°F. Bake on broiling trivet 8 to 10 minutes or until lightly browned. Let cool before filling.
Double Crust	Preheat oven to 400°F. Bake on broiling trivet 25 to 35 minutes on HIGH MIX, 400°F.
Crumb Top	Preheat oven to 400°F. Bake on broiling trivet 20 to 25 minutes on HIGH MIX, 400°F.
Custard Pie	Prebake, following directions for single crust; cool. Fill with desired uncooked custard. Bake on pizza pan on broiling trivet 35 minutes on LOW MIX, 325°F. If custard is not set, let stand in oven a few minutes.
Pecan Pie	Bake on broiling trivet 25 to 30 minutes on LOW MIX, 350°F.
Frozen Prepared Fruit Pies	Place on pizza pan on broiling trivet and bake 30 to 40 minutes using HIGH MIX, 375°F.
Frozen Prepared Custard Pies	Preheat oven to package temperature. Place on broiling trivet and bake three-fourths of package time using LOW MIX, and package temperature. If not set, let stand in oven a few minutes.
Breads	
Loaf: Your recipe or frozen, thawed and proofed	LOW MIX, 350°F. 1 to 2 loaves, 25 to 30 minutes.
Braid or other shape	Remove ceramic turntable from oven. Place bread directly on turntable. LOW MIX, 350°F for three-fourths the conventional time.

MANUAL CONVECTION AND AUTOMATIC MIX COOKING

This section gives you specific cooking instructions and procedures. Please consult your Sharp Carousel Convection Microwave Cookbook for helpful hints for convection and combination cooking.

The oven should not be used without the turntable in place, and it should never be restricted so that it cannot rotate. You may remove the turntable when preheating the oven and when preparing food to be cooked directly on the turntable.

CAUTION The oven cabinet, cavity, door, turntable, turntable support, racks and dishes will become hot. To PREVENT BURNS, use thick oven gloves when removing the food or turntable from the oven.

CONVECTION COOKING

During convection heating, hot air is circulated throughout the oven cavity to brown and crisp foods quickly and evenly. This oven can be programmed for ten different convection cooking temperatures for up to 99 minutes, 99 seconds.

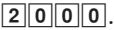

TO COOK WITH CONVECTION

- For example, to cook at 350°F for 20 minutes:
 - 1 Touch the **CONVECT** pad.
 - 2 Select the temperature by touching the number pad .
 - 3 Enter the cooking time by touching the number pads .
 - 4 Touch the **START/TOUCH ON** pad.

Note: If you wish to know the programmed oven temperature, simply touch the **CONVECT** pad. As long as your finger is touching the **CONVECT** pad, the programmed oven temperature will be displayed.

TO PREHEAT AND COOK WITH CONVECTION

Your oven can be programmed to combine preheating and convection cooking operations. You can preheat to the same temperature as the convection temperature or change to a higher or lower temperature.

- For example, to preheat to 350°F and then cook 25 minutes at 375°F convection:
 - 1 Touch the **PREHEAT** pad.
 - 2 Select the temperature by touching the number pad .
 - 3 Touch the **CONVECT** pad.
 - 4 Select the temperature by touching the number pad .
 - 5 Select the cooking time by touching the number pads .

- 6 Touch the **START/TOUCH ON** pad.

When the oven reaches the programmed temperature, a signal will sound 4 times*. The oven will stop, and directions will be displayed. Follow the indicated message.

- 7 Open the door. Place the food in the oven. Close the door. Touch the **START/TOUCH ON** pad.

* If the oven door is not opened, the oven will automatically hold at the preheat temperature for 30 minutes. After this time has elapsed, an audible signal will sound and the oven will turn off.

Note:

- To program only preheat, touch the **START/TOUCH ON** pad after step 2. Preheating will start. When the oven reaches the programmed temperature, follow the indicated message.
- To preheat and cook with the same temperature, enter same temperature in steps 2 and 4.

BROIL

Preheating is automatic when the Broil setting is used. Only actual cooking time is entered; the oven signals when it is preheated to 450°F. Oven temperature cannot be changed. Use Broil setting for steaks, chops, chicken pieces and many other foods. See the Convection Broiling Chart in the cookbook.

- For example, to broil a steak for 15 minutes:
 - 1 Touch the **BROIL** pad.
 - 2 Enter the cooking time by touching the number pads .
 - 3 With no food in the oven, touch the **START/TOUCH ON** pad.

When the oven reaches the programmed temperature, a signal will sound 4 times*.

- 4 Open the door, place the food in the oven and close the door. Touch the **START/TOUCH ON** pad.

* If the oven door is not opened, the oven will automatically hold at the preheat temperature for 30 minutes. After this time has elapsed, an audible signal will sound and the oven will turn off.

Note:

- Preheating for broil may take from 7 to 10 minutes depending on temperature of room and available power.
- Although time is usually set for the maximum broiling time, always check food at the minimum time recommended in the chart of cookbook. This will eliminate the need to completely reprogram the oven if additional cooking time is needed. Simply close the oven door and touch **START/TOUCH ON** to continue.

MANUAL CONVECTION AND AUTOMATIC MIX COOKING

- Should you need more broiling time, reprogram within 1 minute of the end to eliminate preheating.

CAUTION The oven cabinet, cavity, door, turntable, turntable support, racks and dishes will become hot. To PREVENT BURNS, use thick oven gloves when removing the food or turntable from the oven.

SLOW COOK

Slow Cook is preset at 300°F for 4 hours. The temperature can be changed to below 300°F. The cooking time cannot be changed. This feature can be used for foods such as baked beans or marinated chuck steak.

- For example, to change oven temperature from 300°F to 275°F:
 - Touch the **SLOW COOK** pad.
 - Touch the **SLOW COOK** pad once more if you want to change the temperature from 300°F.
 - Select the temperature by touching the number pad **3** 275°F.
 - Touch the **START/TOUCH ON** pad.

Note: If you do not change the temperature, omit steps 2 and 3.

AUTOMATIC MIX COOKING

This oven has two pre-programmed settings that make it easy to cook with both convection heat and microwave automatically.

	OVEN TEMPERATURE	MICROWAVE POWER
High Mix	300°F	30%
Low Mix	350°F	10%

With the exception of those foods that cook best by convection heating alone, most foods are well suited to mix cooking using either Low Mix or High Mix.

The marriage of these two cooking methods produces juicy meats, moist and tender cakes and fine textured breads, all with just the right amount of browning and crispness.

The temperatures can be changed; however, the microwave power cannot.

The oven temperature can be changed from 100°F to 450°F. To change the temperature, first touch **HIGH MIX** or **LOW MIX** then touch the same pad again. When the display says **SELECT TEMP**, touch the desired temperature pad. Ex: **HIGH MIX**, **High mix** pad, **7**. The mix temperature will change to 375°F automatically.

TO COOK WITH AUTOMATIC MIX

- For example, to bake a cake for 25 minutes on Low Mix:
 - Touch the **LOW MIX** pad.
 - Enter the cooking time by touching the number pads **2****5****0****0**.
 - Touch the **START/TOUCH ON** pad.

TO PREHEAT AND COOK WITH AUTOMATIC MIX

Your oven can be programmed to combine preheating and automatic mix cooking operations. You can preheat at the same temperature as the preset combination temperature or change it to a different temperature.

- For example, to preheat to 350°F and then cook 25 minutes on 325°F Low Mix:
 - Touch the **PREHEAT** pad.
 - Touch the temperature pad **6** 350°F.
 - Touch the **LOW MIX** pad.
 - Touch the **LOW MIX** pad once more to change the cooking temperature.
 - Touch the temperature pad **5** 325°F.
 - Enter the cooking time by touching the number pads **2****5****0****0**.
 - Touch the **START/TOUCH ON** pad.

When the oven reaches the programmed temperature, a signal will sound 4 times*. The oven will stop and directions will be displayed. Follow the indicated message.

- Open the door, place the food in the oven and close the door. Touch the **START/TOUCH ON** pad.

* If the oven door is not opened, the oven will automatically hold at the preheat temperature for 30 minutes. After this time has elapsed, an audible signal will sound and the oven will turn off.

Note: To program only preheat, touch the **START/TOUCH ON** pad after step 2. Preheating will start. When the oven reaches the programmed temperature, follow the indicated message.

MANUAL CONVECTION AND AUTOMATIC MIX COOKING

HELPFUL HINTS FOR CONVECTION AND AUTOMATIC MIX COOKING

Your convection microwave oven can cook any food perfectly because of the number of ways it can cook: microwave only, automatic mix, convection only or broil. The cookbook has excellent instructions, guidelines, hints, charts and recipes to help you get the best use of your oven. Consult it often until you are familiar with it. This operation manual tells you how to program the oven.

The oven cannot be used without the turntable in place. Never restrict the movement of the turntable.

CONVECTION COOKING:

- 1 When preheating, the turntable can be left in or removed. When using the high rack for 2 shelf baking in a preheated oven, it is easier to remove the turntable for preheat.

Place the high rack on turntable along with food. When preheat is over, open the oven door and quickly place the turntable, high rack and food to be baked inside.

- 2 Do not cover the turntable, low rack or high rack with aluminum foil. It interferes with air flow that cooks food.
- 3 Round pizza pans are excellent cooking utensils for many convection-only items. Choose pans that do not have extended handles.
- 4 Using a preheated low rack can give a grilled appearance to steaks, hot dogs etc.

AUTOMATIC MIX COOKING:

- 1 Meats are best when roasted directly on the low rack. A dish can be placed below the meat if gravy is to be made from the drippings.
- 2 Less tender cuts of meat can be roasted and tenderized using oven cooking bags.
- 3 When baking, check for doneness after time has elapsed. If not completely done, let stand in oven a few minutes to complete cooking.

Note:

During mix baking, some metal baking utensils may cause arcing when they come in contact with the turntable, oven walls or accessory racks. Arcing is a discharge of electricity that occurs when microwaves come in contact with metal.

If arcing occurs, place a heat resistant dish (Pyrex® pie plate, glass pizza dish or dinner plate) between the pan and the turntable or rack. If arcing occurs with other metal baking utensils, discontinue their use for mix cooking.

HELP/SETTINGS

HELP/SETTINGS provides 5 features which make using your microwave oven easy because specific instructions are provided in the interactive display.

1. SAFETY LOCK

The safety lock prevents unwanted microwave oven operation, such as by small children. The microwave oven can be set so that the control panel is deactivated or locked. To set, touch **HELP/SETTINGS**, the number **[1]** and the **START/TOUCH ON** pads. Should a pad be touched, **LOCK** will appear in the display.

To cancel, touch the **HELP/SETTINGS** and **STOP/CLEAR** pads.

2. AUDIBLE SIGNAL ELIMINATION

If you wish to have the microwave oven operate with no audible signals, touch **HELP/SETTINGS**, the number **[2]** and the **STOP/CLEAR** pads.

To cancel and restore the audible signal, touch **HELP/SETTINGS**, the number **[2]** and the **START/TOUCH ON** pads.

3. AUTO START

If you wish to program your microwave oven to begin cooking automatically at a designated time of day, follow this procedure:

- For example, to start cooking a stew on 50% for 20 minutes at 4:30. Before setting, check to make sure the clock is showing the correct time of day:

- 1 Touch the **HELP/SETTINGS** pad.
- 2 Touch the number **[3]** to select the auto start.
- 3 To enter a start time of 4:30, touch numbers **[4]**, **[3]** and **[0]**.
- 4 Touch the **CLOCK** pad.
- 5 To enter cooking program, touch **POWER LEVEL**, number **[5]** and then touch numbers **[2]**, **[0]**, **[0]**, and **[0]** for cooking time.
- 6 Touch the **START/TOUCH ON** pad. The chosen auto start time will appear in the display.

Note:

- Auto start can be used for manual cooking, Auto Broil, Auto Roast, Auto Bake, if the clock is set.
- If the microwave oven door is opened after programming auto start, it is necessary to touch the **START/TOUCH ON** pad for auto start time to appear in the readout so that the microwave oven will automatically begin programmed cooking at the chosen auto start time.

- Be sure to choose foods that can be left in the microwave oven safely until the auto start time. Acorn or butternut squash are often a good choice.
- If you wish to know the time of day, simply touch the **CLOCK** pad. As long as your finger is touching the **CLOCK** pad, the time of day will be displayed.

4. LANGUAGE SELECTION

The microwave oven comes set for English. To change, touch **HELP/SETTINGS** and the number **[4]** pad. Continue to touch the number **[4]** pad until your choice is selected, then touch the **START/TOUCH ON** pad.

Touch number **[4]** once for English.

Touch number **[4]** twice for Spanish.

Touch number **[4]** three times for French.

5. WEIGHT AND TEMPERATURE SELECTIONS

The microwave oven comes set for U.S. Customary Unit-pounds. To change, touch **HELP/SETTINGS** and the number **[5]**. Continue to touch the number **[5]** until your choice is selected. Then, touch the **START/TOUCH ON** pad.

Touch number **[5]** once for LB / °F.

Touch number **[5]** twice for KG / °C.

HELP

Each setting of Auto Defrost, Auto Broil, Auto Roast, Auto Bake, Sensor Menu, Reheat and Popcorn has a available cooking hint. Touch the **HELP/SETTINGS** pad when HELP is lighted in the interactive display to see the hints.

+60 SEC

+60 SEC allows you to cook for a minute at 100% by simply touching the **+60 SEC** pad. You can also extend cooking time in multiples of 1 minute by repeatedly touching the **+60 SEC** pad during manual cooking.

- For example, to heat a cup of soup for one minute:

Touch the **+60 SEC** pad.

Note:

- To use +60 SEC, touch pad within 1 minute after cooking, closing the door, touching the **STOP/CLEAR** pad or during cooking.
- +60 SEC cannot be used with Reheat, Popcorn, Sensor Menu, Auto Defrost, Auto Broil, Auto Roast or Auto Bake.

OTHER FEATURES

MORE OR LESS TIME ADJUSTMENT

Should you discover that you like any of the Sensor Menu, Reheat, Popcorn or Auto Defrost settings slightly more done, touch the **POWER LEVEL** pad once after touching your selection. The display will show **MORE**.

For slightly less done, touch the **POWER LEVEL** pad twice after touching your selection. The display will show **LESS**.

MULTIPLE SEQUENCE COOKING

Your microwave oven can be programmed for up to 4 automatic cooking sequences, switching from one power level setting to another automatically.

Sometimes cooking directions tell you to start on one power level and then change to a different power level. Your microwave oven can do this automatically.

- For example, to cook roast beef for 5 minutes at 100% and then continue to cook for 30 minutes at 50%:
 - 1 First touch the **POWER LEVEL** pad twice for 100% power. Then enter the cooking time **5|0|0**.
 - 2 Touch the **POWER LEVEL** pad. Touch number pad **5** for 50% power. Then enter second cooking time **3|0|0|0**.
 - 3 Touch the **START/TOUCH ON** pad.

Note:

If the **POWER LEVEL** pad is touched twice, **HIGH** will be displayed.

If you wish to know the power level during cooking, simply touch the **POWER LEVEL** pad. As long as your finger is touching the **POWER LEVEL** pad, the power level will be displayed.

TIMER

- For example, to time a 3 minute long distance phone call:
 - 1 Touch the **TIMER** pad.
 - 2 Enter time by touching the number pads **3|0|0**.
 - 3 Touch the **START/TOUCH ON** pad.

DEMONSTRATION MODE

To demonstrate, touch **CLOCK**, the number **0** and then touch the **START/TOUCH ON** pad and hold for 3 seconds. **DEMO ON** will appear in the display. Cooking operations and specific special features can now be demonstrated with no power in the microwave oven. For example, touch the **+60 SEC** pad and the display will show **1.00** and count down quickly to **END**.

To cancel, touch **CLOCK**, then the number **0** and **STOP/CLEAR** pads. If easier, unplug the microwave oven from the electrical outlet and reconnect.

TOUCH ON

Touch On allows you to cook at 100% power by touching the **START/TOUCH ON** pad continuously. Touch On is ideal for melting cheese, bringing milk to just below boiling etc.

The maximum cooking time is 3 minutes:

- For example, to melt cheese on a piece of toast:
 - 1 Continuously touch the **START/TOUCH ON** pad. The cooking time will begin counting up.
 - 2 When the cheese is melted to desired degree, remove your finger from the **START/TOUCH ON** pad. The microwave oven stops immediately.

Note:

- Take note of the required cooking time for frequently prepared foods and set the microwave accordingly in the future.
- To use Touch On, touch the pad within 1 minute after cooking, opening and closing the door or touching the **STOP/CLEAR** pad.
- Touch On can only be used 3 times in a row. To use Touch On additional times, open and close door or touch **STOP/CLEAR**.

Disconnect the power cord before cleaning or leave the door open to inactivate the microwave oven during cleaning.

EXTERIOR

The outside surface is painted. Clean the outside with mild soap and water; rinse and dry with a soft cloth. Do not use any type of household or abrasive cleaner.

DOOR

Wipe the window on both sides with a damp cloth to remove any spills or spatters. Metal parts will be easier to maintain if wiped frequently with a damp cloth. Avoid the use of spray and other harsh cleaners as they may stain, streak or dull the door surface.

TOUCH CONTROL PANEL

Care should be taken in cleaning the touch control panel. If the control panel becomes soiled, open the microwave oven door before cleaning. Wipe the panel with a cloth dampened slightly with water only. Dry with a soft cloth. Do not scrub or use any sort of chemical cleaners. Close the door and touch the **STOP/CLEAR** pad.

WAVEGUIDE COVER

The waveguide cover is made from mica so it requires special care. Keep the waveguide cover clean to assure good microwave oven performance. Carefully wipe with a damp cloth any food spatters from the surface of the cover immediately after they occur. Built-up splashes may overheat and cause smoke or possibly catch fire. Do not remove the waveguide cover.

INTERIOR - AFTER MICROWAVE COOKING

Cleaning is easy because little heat is generated to the interior surfaces; therefore, there is no baking and setting of spills or spattering. To clean the interior surfaces, wipe with a soft cloth and warm water. **DO NOT USE ABRASIVE OR HARSH CLEANERS OR SCOURING PADS.** For heavier soil, use baking soda or a mild soap; rinse thoroughly with hot water. **NEVER SPRAY OVEN CLEANERS DIRECTLY ONTO ANY PART OF THE MICROWAVE OVEN.**

INTERIOR - AFTER CONVECTION, MIX OR BROIL COOKING

Spatters may occur because of moisture and grease. Wash immediately after use with hot, soapy water. Rinse and polish dry. Harder to remove spatters may occur if oven is not thoroughly cleaned or if there is long time/high temperature cooking. If so, you may wish to purchase an oven cleaner pad with liquid cleaner within it—not a soap filled steel pad—for use on stainless or porcelain surfaces. Follow manufacturer's directions carefully and be especially cautious not to get any of the liquid cleaner in the perforations on the wall or ceiling or any door surfaces. Rinse thoroughly and polish dry.

After cleaning the interior thoroughly, residual grease may be removed from the interior ducts and heater by simply operating the oven on 450°F for 20 minutes without food. Ventilate the room if necessary.

ODOR REMOVAL

Occasionally, a cooking odor may remain in the microwave oven. To remove, combine 1 cup water, grated peel and juice of 1 lemon and several whole cloves in a 2-cup glass measuring cup. Boil for several minutes using 100% power. Allow to set in microwave oven until cool. Wipe interior with a soft cloth.

TURNTABLE / TURNTABLE SUPPORT / RACKS

The turntable, turntable support and racks can be removed for easy cleaning. Wash them in mild, sudsy water; for stubborn stains use a mild cleanser and a non-abrasive scouring sponge. They are also dishwasher-proof. Use top rack of dishwasher for turntable support.

Foods with high acidity, such as tomatoes or lemons, will cause the porcelain enamel turntable to discolor. Do not cook highly acidic foods directly on the turntable; if spills occur, wipe up immediately.

The turntable motor shaft is not sealed, so excess water or spills should not be allowed to stand in this area.

SERVICE CALL CHECK

Please check the following before calling for service:

1 Place one cup of water in a glass measuring cup in the microwave oven and close the door securely.

Operate the microwave oven for one minute at HIGH 100%.

A. Does the microwave oven light come on? YES _____ NO _____

B. Does the cooling fan work? (Put your hand over the rear ventilating openings.) YES _____ NO _____

C. Does the turntable rotate? (It is normal for the turntable to turn in either direction.) YES _____ NO _____

D. Is the water in the microwave oven warm? YES _____ NO _____

2 Remove water from the oven and operate the oven for 5 minutes at CONVECTION 450°F.

A. Do CONV and COOK indicators light? YES _____ NO _____

B. After the oven shuts off, is inside of the microwave oven hot? YES _____ NO _____

If “NO” is the answer to any of the above questions, please check electrical outlet, fuse and/or circuit breaker. If they are functioning properly, CONTACT YOUR NEAREST SHARP AUTHORIZED SERVICER.

A microwave oven should never be serviced by a “do-it-yourself” repair person.

Note:

If time appearing in the display is counting down very rapidly, see Demonstration Mode on pag 30 and cancel.

SPECIFICATIONS

AC Line Voltage:	UL Rating	Single phase 120V, 60Hz, AC only
	CSA Rating	Single phase 117V, 60Hz, AC only
AC Power Required:	UL Rating	1.55 kw, 13.0 amps. (Microwave/Convection)
	CSA Rating	1.5 kw, 13.0 amps. (Microwave/Convection)
Output Power:		
Microwave*	900 watts	
Convection Heater	1450 watts	
Frequency:	2450 MHz (Class B/Group 2)**	
Outside Dimensions:	24 5/8"(W) x 14 7/8"(H) x 19"(D)	
Cavity Dimensions:	16 1/8"(W) x 9 5/8"(H) x 16 1/8"(D)	
Microwave oven Capacity:***	1.5 Cu. Ft.	
Cooking Uniformity:	Turntable system	
Weight:	Approx. 60 lb.	

* The International Electrotechnical Commission's standardized method for measuring output wattage. This test method is widely recognized.

** This is the classification of ISM (Industrial, Scientific and Medical) equipment described in the International Standard CISPR 11.

Class B equipment means that the equipment is suitable to be used in domestic establishments.

Group 2 means that the equipment intentionally generates radio-frequency energy in the form of electromagnetic radiation for the heat treatment of food.

*** Internal capacity is calculated by measuring maximum width, depth and height. Actual capacity for holding food is less.

In compliance with standards set by:

FCC – Federal Communications Commission Authorized.

DHHS – Complies with Department of Health and Human Services (DHHS) rule, CFR, Title 21, Chapter I, Subchapter J.

Health Canada – Complies with Health Canada, Radiation Emitting Device Regulation for microwave oven.



– This symbol on the nameplate means the product is listed by Underwriters Laboratories, Inc. for use in USA or Canada.