

# CB300UI



<b>Product family</b>	Refrigerator
<b>Installation</b>	Built-in
<b>Category</b>	Bottom mount
<b>No-frost system</b>	Total
<b>Cooling type</b>	Fan-assisted refrigerator, no-frost freezer
<b>Defrost</b>	Automatic
<b>Hinge</b>	Door-to-door
<b>Hinge position</b>	Right
<b>Reversible door</b>	Yes
<b>EAN code</b>	8017709246884



## Aesthetic



<b>Finishing</b>	Panel-ready	<b>Glass shelf profile color</b>	White
<b>Material</b>	Steel	<b>Display</b>	LED
<b>Side material</b>	Steel	<b>Display position</b>	Internal
<b>Logo</b>	Silkscreened		

## Refrigerator compartment features



<b>No. of adjustable shelves</b>	3	<b>Crisper cover</b>	Yes
<b>Number of fruit and vegetables drawers</b>	2	<b>Refrigerator lighting</b>	LED
<b>Type of adjustable shelves</b>	Glass		

## Refrigerator Inner Door

<b>No. of door shelves with transparent cover</b>	1	<b>No. of bottle shelves</b>	1
<b>Number of adjustable door shelves</b>	1	<b>Door bin with wire support</b>	Yes

## Other Refrigerator features



<b>Fan</b>	Yes	<b>Anti-odour filter</b>	Yes
------------	-----	--------------------------	-----

## Freezer features

<b>Number of drawers</b>	2	<b>No. of shelves</b>	1
--------------------------	---	-----------------------	---

## Other Freezer features



<b>Accessories</b>	1 x ice box	<b>Fast-freezing compartment</b>	Yes
<b>Ice maker</b>	Yes		

## Other technical features



<b>Display functions</b>	Holiday, Fast-freezing, Fast-cooling, ECO
<b>Fast-freezing button</b>	Yes
<b>Water network connection</b>	Yes
<b>Power-on light</b>	Yes
<b>Temperature alarm</b>	Yes
<b>Door open alarm</b>	Yes
<b>Temperature setting type</b>	Electro-mechanical
<b>No. of compressors</b>	1
<b>Refrigerant gas type</b>	R600a
<b>Foam agent</b>	Cyclopentane

## Performance / Energy Label NEW

<b>Noise level</b>	39 dB(A) re 1pW
--------------------	-----------------

## Electrical Connection



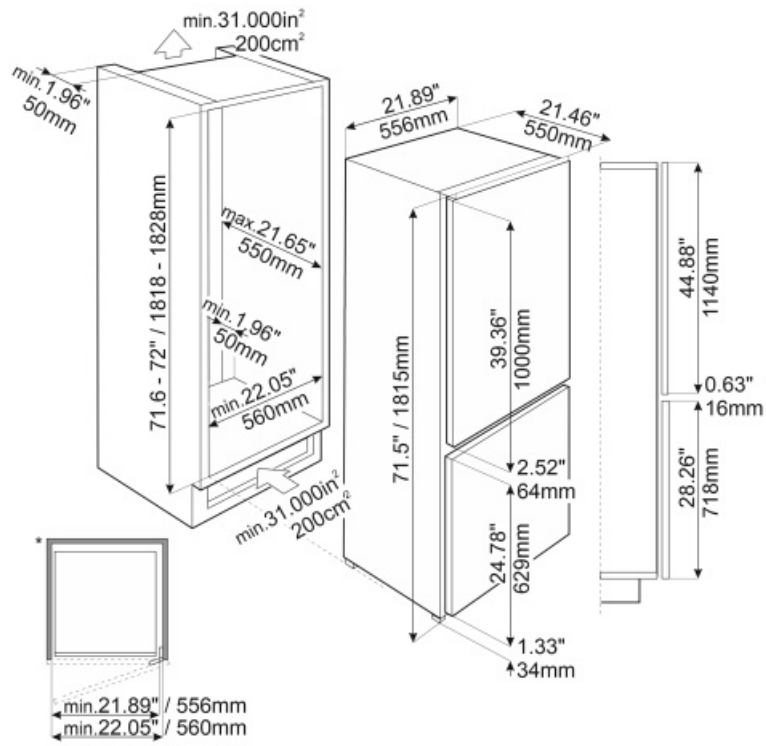





<b>Plug</b>	(A) USA & Mexico	<b>Voltage (V)</b>	120 V
<b>Electrical connection rating</b>	170 W	<b>Frequency (Hz)</b>	60 Hz
<b>Current</b>	2,1 A	<b>Power cord length</b>	84 5/8 "



---

## Symbols glossary (TT)

---

	The automatic defrost system works by automatically defrosting at regular intervals eliminating the need to defrost altogether.		LED display: to show programmes, functions and options selected and the time to the end of the cycle.
	Economical mode: Analyzes fridge functioning during the activation and optimizes the operating cycle in order to reduce power consumption.		Ventilated: Forced distribution of cold air in the refrigerator compartment, which allows even temperature distribution within the fridge.
	Fast freezing: The fast freezing function brings the temperature of the compartment down when activated a few hours prior to usage.		Power saving mode: The power saving mode allows you to disable the refrigerator and keep the freezer working.
	LED interior lighting: is a more energy efficient and long lasting way of illuminating the interior of the appliance.		No Frost: The No Frost and Frost free systems prevent ice from forming so that no defrosting is required.