

# FC20UXDNE



Product Family	Refrigerator
Installation	Free standing
Category	Bottom Mount
Reference width	Until 60
Cooling type	Total No Frost
Defrost	Automatic
Hinge type	Standard
Slot-in	Yes
Kitchen panel	Not supplied
Hinge position	Right
Reversible door	Yes
EAN code	8017709312992



## Aesthetics



Aesthetic	Universale	Side colour	Silver
Colour	Stainless steel	Logo	Applied
Finishing	Fingerproof	Door shelves profile color	White
Material	Steel Effect	Color of glass shelf profile	Silver
Door steel type	Finger proof	Display	LED
Handle	External	Display position	Esterno (su porta)
Side material	Steel		

## Refrigerator compartment features



No. of adjustable shelves	3	Bottle shelf	Yes
Number of fruit and vegetables drawers	1	Low temperature compartment	Yes
Type of adjustable shelves	Glass	Type of internal light (fridge)	LED
Type of crisper/vegetable drawers cover	On sliding rails		

## Refrigerator Inner Door

Number of adjustable door shelves	3	No. of bottle shelves	1
-----------------------------------	---	-----------------------	---

## Other Refrigerator features



Accessories

Egg tray

MultiFlow

Yes

## Freezer compartment features

Number of drawers 3

## Other technical features



Functions display	Fast freezing, ECO
Temperature alarm lamp	Yes
Door open alarm	Yes
Type of temperature control	Electronic
No. of compressors	1
Refrigerant gas type	R600a
Type of compressor	Standard
Refrigerant Quantity (gr)	1.1 oz
Foam agent	Cyclopentane

## Performance / Energy Label - Reg. 2019







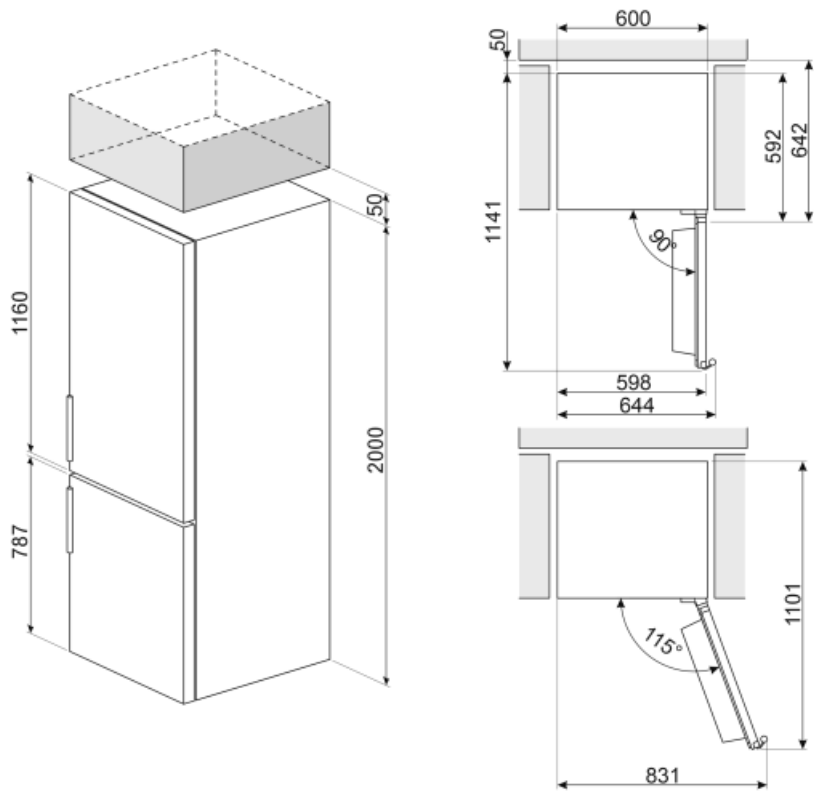

Airborne acoustical noise emissions 38 dB(A) re 1pW

## Electrical Connection

Plug	(A) USA e Messico	Frequency (Hz)	60 Hz
Current	10 A	Power supply cable length	74 13/16 "
Voltage (V)	120 V		



## Symbols glossary (TT)

	The automatic defrost system works by automatically defrosting at regular intervals eliminating the need to defrost altogether.		LED display: to show programmes, functions and options selected and the time to the end of the cycle.
	Economical mode: Analyzes fridge functioning during the activation and optimizes the operating cycle in order to reduce power consumption.		Fast freezing: The fast freezing function brings the temperature of the compartment down when activated a few hours prior to usage.
	Fingerprint proof stainless steel: Fingerprint proof stainless steel keeps stainless steel looking as good as new.		LED interior lighting: is a more energy efficient and long lasting way of illuminating the interior of the appliance.
	Air plus: keeps food fresher for longer.		Slot-in: The refrigerators with Slot-in opening can be perfectly integrated into the furniture structure, as the doors open at 90° do not go beyond the side of the product. In case of installation next to the wall, it will be necessary to consider the dimensions of the handle in order to open the door at 90°.