

Table of Contents

1 Installation	9
1.1 General installation instructions	9
1.2 Electrical requirements	10
1.3 Electrical connection	11
1.4 Positioning	15
1.5 Cutting out the countertop	16
1.6 Recess	19

EN

Important Notes to the Installer

IMPORTANT SAFETY INSTRUCTIONS



WARNING

If the instructions contained in this manual are not followed correctly, fire or explosion may result causing property damage, personal injury or loss of life.

INSTALLATION AND SERVICE MUST BE PERFORMED BY A QUALIFIED INSTALLER.

IMPORTANT: SAVE FOR THE LOCAL INSPECTOR'S USE.

- Read all instructions contained in these installation instructions before installing the cooktop.
- Remove all packing material from the oven and the drawer compartments before connecting the electrical sply to the cooktop.
- Observe all governing codes and ordinances. Be sure to leave these instructions with the consumer.

Important Note to the Customer

- Keep these instructions with your owner's guide for future reference.

Definitions

- This manual contains important safety symbols and instructions.
- Please pay attention to these symbols and follow all instructions given.



Important Safety Instructions

Appliance Handling Safety



WARNING

This symbol will help alert you to situations that may cause serious bodily harm, death or property damage.



CAUTION

This symbol will help alert you to situations that may cause injury or property damage.

Hidden surfaces may have sharp edges. Use caution when reaching behind or under the appliance.

- Wear gloves to avoid cutting fingers on sharp edges during installation.

The unit is heavy and requires at least two persons or proper equipment to move it.

Safety Codes and Standards

This appliance complies with one or more of the following Standards:

UL 858 - The Standard for the Safety of Household Electric Ranges

CAN/CSA-C22.2 No. 61 Household Cooking Ranges

- It is the responsibility of the owner and the installer to determine whether additional requirements and/or standards apply to specific installations.
- The appliance must be electrically grounded in accordance with local codes or, in the absence of local codes, with the National Electrical Code, NFPA 70 latest edition or, in Canada, the Canadian Electric Code, CSA C22.1-02.



WARNING

Never leave children alone or unattended in the area where an appliance is in use. As children grow, teach them the proper and safe use of all appliances.



CAUTION

Stepping, leaning, or sitting on this cooktop can result in serious injuries and can also cause damage to the cooktop.

- Do not store items of interest to children in the cabinets above the cooktop. Children could be seriously burned if they climb on the cooktop to reach items.

Important Safety Instructions



- Do not store or use gasoline or other flammable vapors and liquids near this or any other appliance. Explosions or fires could result.



WARNING

Do not repair, replace or remove any part of the appliance unless specifically recommended in the manuals. Improper installation, service or maintenance can cause injury or property damage. Refer to this manual for guidance. All other servicing should be done by an authorized service provider.

Electric Safety



WARNING

Before you plug the electrical cord into an outlet, make sure that all the appliance controls are in the OFF position.

- Personal injury or death from electrical shock may occur if the appliance is not installed by a qualified installer or electrician.
- Make sure your appliance is properly installed and grounded by a qualified electrician. Installation, electrical connections and grounding must comply with all applicable codes.
- Before installing, turn power OFF at the service panel. Lock the service panel to prevent power from being turned ON accidentally.
- For appliances equipped with a cord and plug, do not cut or remove the ground prong. It must be plugged into a matching grounding type outlet to avoid electrical shock. If there is any doubt as to whether the wall outlet is properly grounded, the customer should have it checked by a qualified electrician.
- Do not use an extension cord.
- Do not use an adapter.
- If required by the National Electrical Code (or Canadian Electrical Code), this appliance must be installed on a separate branch circuit.
- The circuit breaker should have a contact separation of at least 3 mm on all poles.
- INSTALLER – show the owner the location of the circuit breaker or fuse. Mark it for easy reference.
- Refer to rating label for more information.



Important Safety Instructions

Proposition 65 Warning:

This product may contain a chemical known to the State of California, which can cause cancer or reproductive harm. Therefore, the packaging of your product may bear the following label as required by California:

State of California Proposition 65



WARNING

Cancer or Reproductive Harm -
www.P65Warnings.ca.gov

Related Equipment Safety

- The appliance should only be used if installed by a qualified technician in accordance with these installation instructions and all applicable regulations and codes. The manufacturer is not responsible for damages resulting from incorrect installation.
- Remove all tape and packaging before using the appliance. Dispose of the packaging after unpacking the appliance. Never allow children to play with packaging material.
- Never modify or alter the construction of the appliance.

- To eliminate the risk of burns or fire by reaching over hot surface units, cabinet storage space located above the surface units should be avoided. If cabinet storage is to be provided, the risk can be reduced by installing a hood that projects horizontally a minimum of 5 inches (127 mm) beyond the bottom of the cabinet. Be sure cabinets above the cooktop are a maximum of 13 in (330 mm) deep.
- When installing a cooktop over a single oven, be sure to follow both the oven and cooktop installation manuals.

Ventilation Recommendations

- Do not obstruct air vents or heat vent openings.
- We strongly recommend the installation of a ventilation hood above this appliance. The hood must be installed according to the instructions provided with the hood.

Important Safety Instructions



EN

High-altitude installation

- This appliance can operate up to an altitude of 10,000 ft (3048 m) elevation above sea level. If desired, for altitudes above 2,000 ft (610 m) elevation above sea level, adjustments may be made.
- It is required that a Certified Professional make the high altitude adjustments during installation.



WARNING

If the information in this manual is not followed exactly, fire or shock may result causing property damage or personal injury.

- **Improper installation is not covered by the warranty.**
- Read all instructions
- Proper installation is your responsibility. Have a qualified technician install and ground this appliance in accordance with these installation instructions.
- It is the responsibility of the installer to comply with installation information specified on the model/serial ID plate. The ID plates are visibly located under the appliance. These ID plates must never be removed.

- **ELECTRICAL GROUNDING IS REQUIRED:** See the “Electrical Requirements” section. It is the customer’s responsibility to:
- Contact a qualified electrician to install the appliance
- Ensure that the electrical system is adequate and in compliance with the National ANSI / NFPA 70 ELECTRICAL CODE – latest edition – Or the CANADIAN ELECTRICAL CODE, C22.11 – 1 and C22.2 No. 01982 – or latest edition – and all local codes and ordinances. **IMPORTANT:** Observe all governing codes and ordinances.
- Never modify or alter the construction of the appliance. For example, do not remove adjustable legs, panels, wiring or anti-tip brackets/screws.



CAUTION: This unit is designed as a cooking appliance. For safety purposes, never use it for warming a room or as a space heater.

- Do not obstruct heat vents or openings on the appliance.
- Test the appliance immediately after installation, following the instructions in this booklet. If the appliance does not work properly, disconnect it from the electrical power supply and call the Customer Service Center. **DO NOT** attempt to repair the appliance.



Important Safety Instructions

- All adjustments and servicing must be performed by qualified installers or service technicians.
- Do not leave the packing materials around the home. Sort the various items of waste and take them to the nearest specialized waste collection facility.
- Do not store or use gasoline or other flammable vapors, liquids or materials near this or any other appliance.

How to read the user manual

This user manual uses the following reading conventions:

Instructions



General information on this user manual, on safety, and on final disposal.

Description



Description of the appliance and its accessories.

Use



Information on the use of the appliance and its accessories, cooking advice.

Cleaning and maintenance



Information for proper cleaning and maintenance of the appliance.



Safety instructions



Information

1. Order of use instructions.
- Stand-alone instructions.

SAVE THESE INSTRUCTIONS



1 Installation

1.1 General installation instructions

- **Proper installation is your responsibility.** Have a qualified technician install this appliance. Make sure you have everything necessary for correct installation. It is the responsibility of the installer to comply with installation guidelines indicated on the model/serial ID plate. The model/serial ID can be found under the appliance.
- **Have your appliance installed and properly grounded by a qualified installer, in accordance with these installation instructions.** Grounding is mandatory according to the provisions of the electrical system safety regulations. If this appliance is connected to an outside electrical power source, it must be grounded in compliance with local laws, or, if no local laws exist, in compliance with the national ANSI/NFPA 70 code of electrical regulations.
- Make sure that the voltage and dimensions of the supply line correspond to the information indicated on the model/serial rating plate. A multi-pole circuit breaker must be available on the supply line with contact gap equal to or greater than 3mm, located in an easily accessible position near the appliance.

- Do not attempt to repair or replace any part of the appliance unless specifically recommended in this manual. All other service procedures should be performed by a qualified technician.
- This appliance is not suitable for installation and use in mobile homes or campers.
- **Electrical grounding is required.** See the "Electrical requirements" section. It is the customer's responsibility to:
 1. Contact a qualified electrical installer.
 2. Ensure that the electrical system is adequate and in compliance with the National ANSI / NFPA 70 ELECTRICAL CODE – latest edition – Or the CANADIAN ELECTRICAL CODE, C22.11 – 1982 and C22.2 No. 01982 - or latest edition - and all local codes and ordinances.

IMPORTANT: Observe all codes and ordinances in force.



In case of multiple installations, cooktops cannot be installed adjacent to each other.



Installation

1.2 Electrical requirements



Warning Electrical shock hazard

- Have the electrical connection performed by authorized technical personnel.
- The frame is grounded by connecting the grounding lead to the neutral lead. If local codes do not permit grounding through the neutral lead, open the connection and use the grounding lead to ground the unit in accordance with local codes. Connect the neutral lead to the branch-circuit neutral conductor in the usual manner.
- Do not use an adapter.
- Do not use an extension cord.
- Check with a qualified electrician if you are not sure whether the appliance is grounded.
- Turn the power supply off before connecting the wires.
- Ground the appliance electrically.
- Failure to follow these instructions can result in death, fire, or electrical shock.
- Improperly connecting the appliance's grounding conductor can result in electrical shock. Check with a qualified electrician or service technician if you are in doubt as to whether the appliance is properly grounded. Do not modify the power supply cord. If it does not fit in the outlet, have a proper outlet installed by a qualified electrician.
- Disconnect the main power supply.



FAILURE TO FOLLOW THESE INSTRUCTIONS COULD RESULT IN DEATH, FIRE OR ELECTRICAL SHOCK.

Make sure that the power line rating matches the specifications indicated on the ID plate. The ID plates are visibly located under the appliance.

These ID plates must never be removed.

- If codes permit and a separate ground wire is used, it is recommended that a qualified electrician check the suitability of the ground path.
- Wire size and connections must conform to the requirements of the National Electrical Code, ANSI/NFPA 70 ELECTRICAL CODE (*) – latest edition or CSA Standard C22.1-94, Canadian Electrical code, Part 1 (***) and CSA C22.2 No. 0-91 or latest edition and all local codes and ordinances for the kilowatt rating of the appliance. IMPORTANT: Observe all governing codes and ordinances.
- Copies of the standards listed above may be obtained from:
 - (*) National Fire Protection Association, One Batterymarch Park, Quincy, Massachusetts 02169-7471
 - (***) CSA International 8501 East Pleasant Valley Road Cleveland, Ohio 44131-5575.



1.3 Electrical connection



Warning

Electrical shock hazard

- Disconnect power to the junction box before connecting.
- Electrically ground the appliance using the green or green-yellow wire.



FAILURE TO FOLLOW THESE INSTRUCTIONS COULD RESULT IN DEATH, FIRE OR ELECTRICAL SHOCK.

This appliance is manufactured with a green or green-yellow ground wire connected to the frame of the appliance.

To prepare the connection between the appliance and the junction box:

- Disconnect the power supply to the junction box.
- Feed the flexible cable conduit from the appliance through the opening of the cabinet.
- Remove the junction box cover, if present.
- Install a UL-listed or CSA-approved conduit connector to the junction box.
- Route the flexible cable conduit from the appliance to the junction box through a UL-listed or CSA-approved conduit connector.
- Tighten the screws on the conduit connector.

IMPORTANT: Any local codes or ordinances should be given priority over these instructions.

The frame is grounded by connecting the grounding wire to the neutral wire. If the new branch circuit installation (1996 NEC) is used or if local codes do not permit grounding through the neutral wire, open the connection and use the grounding wire to ground the unit in compliance with local codes. Connect the neutral wire to the branch circuit's neutral conductor in the usual manner:

- Disconnect the ground from the neutral at the free end of the conduit.
- Use the grounding terminal or lead to ground the unit.
- Connect the neutral terminal or wire to the branch circuit neutral in the usual manner.
- This range is equipped with a factory connected power cord. The cord must be connected to a grounded 120/240 volt or 120/208 volt outlet. If no outlet is available, have one installed by a qualified electrician.



Installation

U.S. Installation only / 3-wire branch circuit

Refer to figure, where local codes allow the connection of the ground wire from the oven to the power supply cable neutral wire (white wire):

- The ground wire must be connected first;
- If local codes permit, connect the green or yellow-green ground wire from the range and the white wire from the range to the power supply neutral wire (white wire).
- Connect the red and black leads from the range to the matching color wires in the junction box using UL/CSA listed wire connectors.

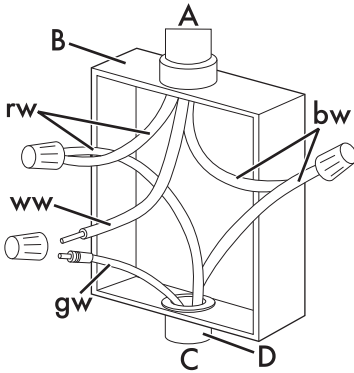

A	cable from power supply
B	junction box
C	cable from range
D	UL/CSA listed conduit connector

U.S. and Canada installation / 4-wire branch circuit

- Separate the green or yellow-green wires from the white wires that extend out of the end of the appliance cable.
- The ground wire must be connected first.
- Connect the green or yellow-green ground wire from the appliance to the ground wire in the junction box (green colored wire) using UL/CSA listed wire connectors. Do not connect the grounding wire to the neutral wire in the junction box.
- Connect the red and black leads from the appliance to the matching color wires in the junction box using UL/CSA listed wire connectors.
- Connect the white wire from the appliance to the neutral white wire in the junction box using a UL/CSA listed wire connector.

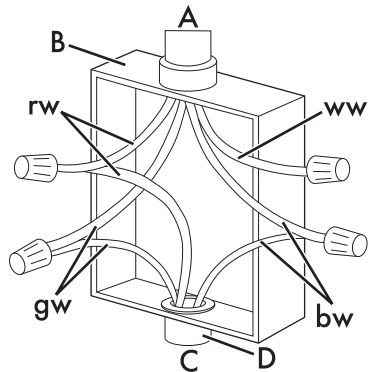

bw	black wires
gw	white-green or yellow-green wires
rw	red wires
ww	white wires



- Connect to a fuse or circuit breaker:

Model	Fuse
up to 4.3 kW	20A
from 4.4 kW to 6.6 kW	30A
from 6.7 kW to 8.8 kW	40A
from 8.9 kW to 11.0 kW	50A

To modify the maximum power input of the appliance, it is necessary to access the user menu.

- Connect to copper wire, or, if connection is made to aluminum house wiring, use UL-listed or CSA-approved connectors approved for joining aluminum and copper wiring.



NOTE: Both leads coming out of the range must be connected according to the diagrams shown in figures.

Fixed connection

Fit the power line with a multi-pole circuit breaker in compliance with installation regulations.

The circuit breaker should be located near the appliance and in an easily reachable position.

Instructions for the installer





- Do not bend or trap the power sply cord.
- The appliance must be installed according to the installation diagrams.
- If the appliance does not work correctly after having carried out all the checks, contact your local Authorized Service Center.
- Once the appliance has been installed, please explain to the user how to use it correctly.

Power limitation procedure (for installer only)



Installation

Accessing the user menu

1. If the cooktop is off, switch it on using the On/Off button .
2. Then press the On/Off button  again immediately to switch it off: the pause button  starts to flash.
3. Press and hold the pause button .

Some symbols will appear on the cooking zone displays that must be pressed in sequence in order to access the menu options.

Press all the buttons of the cooking zones in sequence in a clockwise direction starting from the front left. Every effective touch will be confirmed by a beep.

15 in - 380 mm model:



24 in - 610 mm and 30 in - 762 mm models:



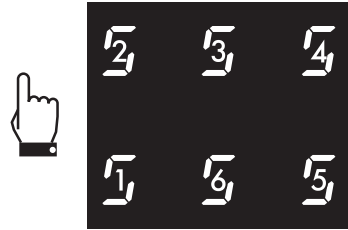

36 in - 914 mm model:



 **NOTES:** If the sequence of the buttons is selected incorrectly, the cooktop will be turned off and the procedure for accessing the menu will have to be repeated.

4. Release the pause button .

The user menu is active and the  symbol alternating with the number  will appear at the top of the cooking zones display.

 **NOTES:** This option is restricted to the installer.

5. Press the  symbol to go back to selecting the options. The scroll bar appears in which each segment is associated with a menu option.

Press the segments of the scroll bar (except the first two) to select the available options.



Once the user menu has been accessed, the first available option is indicated by



111 (Maximum total power). A total of 7 options can be modified.

- Once the user menu has been accessed, the **11** symbol alternating with the **0** symbol will appear at the top of the cooking zone display.
- The timer display on the other hand, indicates the default power setting **3.7** (15 in - 380 mm), **7.4** (24 in - 610 mm and 30 in - 762 mm models) and **11.1** (36 in - 914 mm model).
- Press the timer display to enable changes to the power settings.
- Press the left side of the scroll bar to decrease the power and the right side to increase it.

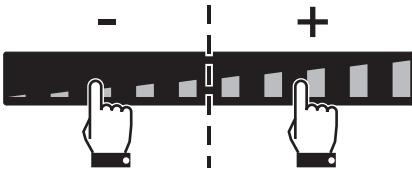

The **Eco-Logic Advance** function increases or decreases the power level in steps of 0.1 kW at each touch.

To exit from the user menu:

- Press the On/Off button  for at least 2 seconds to save the modifications.
- Press the pause button  to exit without saving the modifications.

In both cases, the cooktop will be switched off and will have to be turned back on.

Power draw table (kW)

Model	Max.	min.
15 in - 380 mm	3.7	2.4
24 in - 610 mm	7.4	2.4
30 in - 762 mm	7.4	2.4
36 in - 914 mm	11.1	2.4



Installation

1.4 Positioning



Increasing heat when the appliance is in operation
Risk of fire

- Check that the surrounding cabinetry material is heat-resistant.
- Check that the cabinetry has the required openings.
- Do not obstruct the ventilation grille in front of the product during installation.



The following requires building and/or carpentry work, which must be carried out by a competent technician.

The appliance may be installed on various materials such as masonry, metal, solid wood and plastic laminated wood, provided they are heat resistant (>90°C - 194°F).



Warning
Electrical shock hazard

- To eliminate the risk of burns or fire by reaching over hot surface units, cabinet storage space located above the surface units should be avoided. If cabinet storage is to be provided, the risk can be reduced by installing a cooktop hood that projects horizontally a minimum of 5 inches beyond the bottom of the cabinets.

Veneers, adhesives or plastic coatings on adjacent units should be heat-resistant (>90°C), otherwise they might warp over time.

The minimum clearance between extractor hoods and the cooking surface must be at least the distance indicated in the extractor hood installation instructions.

The minimum clearances of the cutouts for the cooktop on the back side as shown in the mounting illustrations must also be observed.

Spacer bracket

- Screw the spacer brackets onto the sides of the appliance.

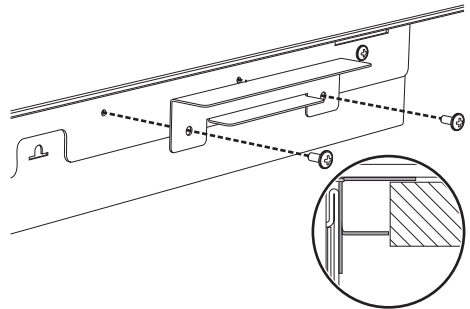

Refer to the side spacer brackets for correct installation.

The side spacer brackets should never be removed. Their removal is considered as tampering with the device.



1.5 Cutting out the countertop

Cut an opening in the countertop of the unit according to the dimensions shown (mm).

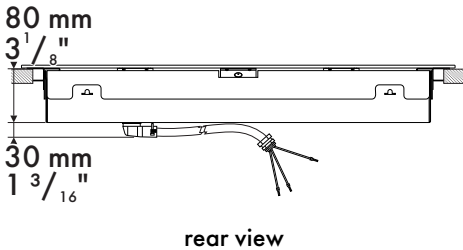
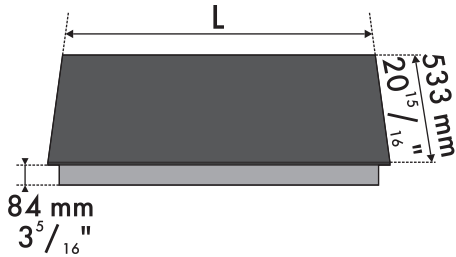

Semi-flush mounting

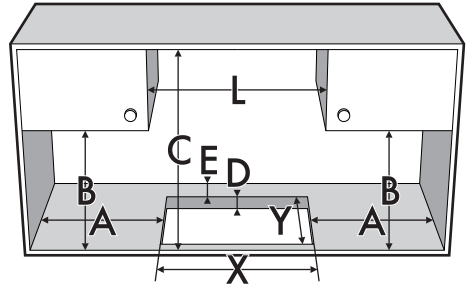

L	X	Y
SIMU315D 15 in - 380 mm	12 ⁹ / ₁₆ " 320 mm	19 ⁵ / ₁₆ " 490 mm
SIMU324D 24 in - 610 mm	22 ¹³ / ₁₆ " 580 mm	19 ⁵ / ₁₆ " 490 mm
SIMU330D 30 in - 762 mm	29 ⁵ / ₁₆ " 745 mm	19 ⁵ / ₁₆ " 490 mm
SIMU336D 36 in - 914 mm	34 ⁵ / ₈ " 880 mm	19 ⁵ / ₁₆ " 490 mm

	inches	mm
A min.	1 ¹⁵ / ₁₆ "	50
B min.	18 ¹ / ₈ "	460
C min.	30"	762
D	$\frac{3}{4} \div 2 \frac{3}{8}$	20 ÷ 60
E min.	1 ¹⁵ / ₁₆ "	50

C = 30" - 762 mm minimum clearance between the top of the cooking surface and the bottom of an unprotected wood or metal cabinet.



Installation

Seal the cooktop

Before assembly, to prevent leakage of liquid between the frame of the cooktop and the countertop, place the provided adhesive seal along the entire perimeter of the cooktop.

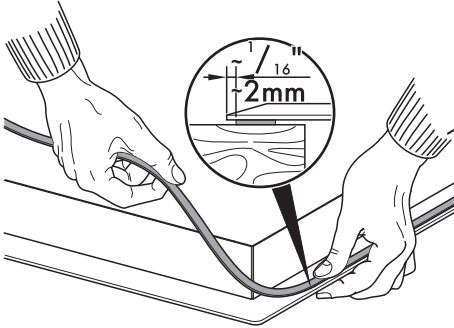

Do not attach the cooktop with silicone. It will prevent the cooktop from being removed when necessary without damage.

Flush mounting

This type of cooktop requires an additional cut to be made in the recess if you wish to install the hob flush with the countertop.

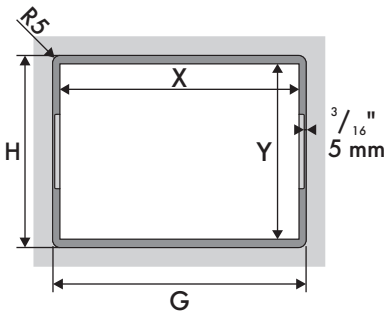

G	H
15 1/8" - 384 mm	21 1/8" - 537 mm
24 3/16" - 614 mm	21 1/8" - 537 mm

30 3/16" - 766 mm	21 1/8" - 537 mm
36 1/8" - 918 mm	21 1/8" - 537 mm

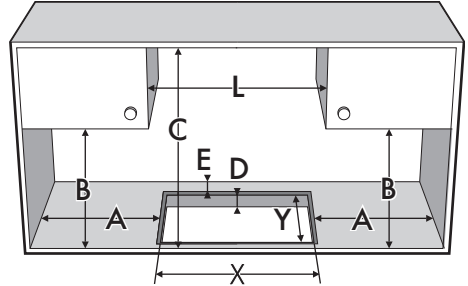

L	X	Y
SIMU315D 15 in - 380 mm	12 9/16" 320 mm	19 5/16" 490 mm
SIMU324D 24 in - 610 mm	22 13/16" 580 mm	19 5/16" 490 mm
SIMU330D 30 in - 762 mm	29 5/16" 745 mm	19 5/16" 490 mm
SIMU336D 36 in - 914 mm	34 5/8" 880 mm	19 5/16" 490 mm

	inches	mm
A min.	1 15/16"	50
B min.	18 1/8"	460
C min.	30"	762
D	3/4 ÷ 2 3/8	20 ÷ 60
E min.	1 15/16"	50

Once the adhesive seal (A) has been applied to the glass surface and the cooktop has been positioned and clamped in place, fill the edges with insulating silicone (B) and remove any excess. If for any reason the cooktop needs to be



removed, cut the silicone with a cutter before attempting to remove it (C).

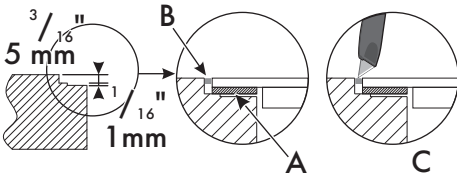

1.6 Recess

On a hollow compartment or drawer

i Check the oven's installation manual for compliance with all required safety distances.

If there are other furniture parts (side panels, drawers, etc.), dishwashers or refrigerators, under the cooktop, a double-layer wooden base must be installed at a minimum distance of **51 mm (2 in)** from the underside of the cooktop to prevent accidental contact. The double-layer base must be removed using only the appropriate tools.

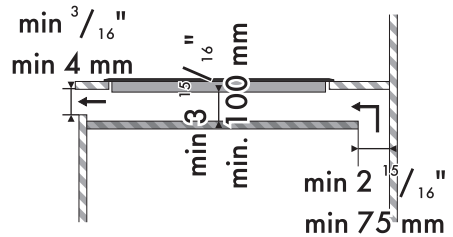
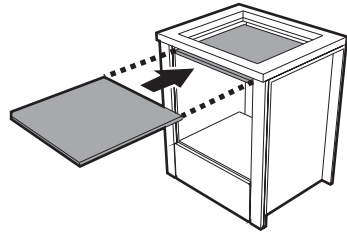

with opening on the base



Installation

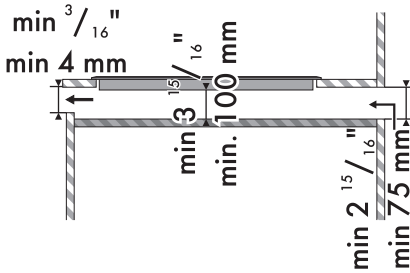

with opening on the back



Failure to install the double-layer wooden base exposes the user to possible accidental contact with sharp or hot surfaces.

Fixing brackets

- Screw the fixing brackets into the holes on the lower sides of the casing to properly secure the cooktop to the structure.

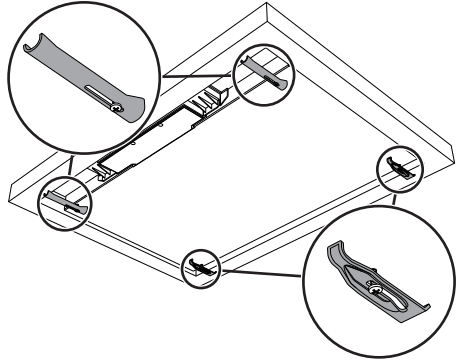

Fastening clips

To ensure the attachment and optimal centering, you should use the splied clips:

1. Insert the clips and fix them in place horizontally into the groove with light pressure.

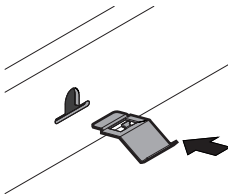

2. Rotate them wards to fix them in place permanently.

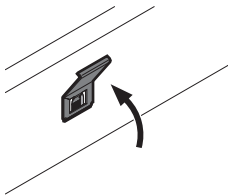

Fixing the cooktop too tightly may strain the glass and cause it to break.



Do not use silicone to secure the cooktop. Doing so would make it impossible to remove the cooktop without damage.