

Use and care
GUIDE

Freedom® Induction Cooktop

CIT30XWBB



Table of CONTENTS

▲ Safety Definitions	4	Pause function	30
IMPORTANT SAFETY INSTRUCTIONS	5	Automatic Shutoff	30
Fire Safety	5	Basic Settings	30
Cooking Safety	5	Home Connect	32
Burn Prevention	6	Connection to your home network	32
Child Safety	6	Home Connect Settings	34
Cleaning Safety	6	Software Update	36
Cookware Safety	7	Information on Data Protection	36
Proper Installation and Maintenance	7	Wi-Fi® Module	36
Electromagnetic interference	7	Cooktop - Hood Sync	37
Cooling fan	8	Setting up a connection	37
Proposition 65 Warning	8	Disconnecting from the network	38
Causes of damage	9	Controlling the hood via the cooktop	38
Overview	9	Hood control settings	39
Protecting the Environment	9	Cleaning and Maintenance	39
Energy-saving Advice	9	Daily Cleaning	39
Cooking with Induction	10	Cleaning guidelines	39
Advantages of Induction Cooking	10	Cleaning chart	40
Cookware	10	Maintenance	40
Familiarizing yourself with your appliance	11	Frequently-asked questions and answers (FAQ)	41
Cooking surface	11	Troubleshooting	43
The control panel	11	Warnings and fault messages	43
Overview of the Menus	12	Tips	44
Cooking Position Display	13	Demo mode	45
Residual Heat Indicator	13	How to Obtain Warranty Service	45
Operating the Appliance	14	STATEMENT OF LIMITED PRODUCT WARRANTY ...	45
First-time use	14	What this Warranty Covers & Who it Applies to	45
Switching the cooktop on and off	14	How Long the Warranty Lasts	45
Setting a cooking position	14	Repair/Replace as Your Exclusive Remedy	46
Chef's recommendations	15	Out of Warranty Product	46
Timer functions	17	Warranty Exclusions	46
PowerBoost® Function	19	THERMADOR® Support	47
PanBoost™ Function	19	Service	47
Keep Warm	20	Parts and Accessories	47
Transfer function	20		
Wireless Cooking Sensor	20		
Cooking Sensor Mode	23		
MyZone™	28		
TeppanyakiPro™ Mode	29		
Panel Lock	30		

This THERMADOR Appliance is made by
BSH Home Appliances Corporation
1901 Main Street, Suite 600
Irvine, CA 92614

Questions?

1-800-735-4328

www.thermador.com

We look forward to hearing from you!

Safety Definitions

WARNING

This indicates that death or serious injuries may occur as a result of non-observance of this warning.

CAUTION

This indicates that minor or moderate injuries may occur as a result of non-observance of this warning.

NOTICE: This indicates that damage to the appliance or property may occur as a result of non-compliance with this advisory.

Note: This alerts you to important information and/or tips.

IMPORTANT SAFETY INSTRUCTIONS

READ AND SAVE THESE INSTRUCTIONS

WARNING

When properly cared for, your new appliance has been designed to be safe and reliable. Read all instructions carefully before use. These precautions will reduce the risk of burns, electric shock, fire, and injury to persons. When using kitchen appliances, basic safety precautions must be followed, including those in the following pages.

Examine the appliance after unpacking it. In the event of transport damage, do not plug it in.

Fire Safety

Do not allow aluminum foil, plastic, paper or cloth to come in contact with a hot surface element, burner or grate. Do not allow pans to boil dry.

If the cooktop is near a window, forced air vent or fan, be certain that flammable materials such as window coverings do not blow over or near the burners or elements. They could catch on fire.

Always have a working smoke detector near the kitchen. Never leave the cooktop unattended when in use. Boilovers cause smoking and greasy spillovers may ignite.

WARNING

TO REDUCE THE RISK OF A GREASE FIRE:

- a. Never leave surface units unattended at high settings. Boilovers cause smoking and greasy spillovers that may ignite. Heat oils slowly on low or medium settings.
 - b. Always turn hood ON when cooking at high heat or when flambéing food (i.e. Crepes Suzette, Cherries Jubilee, Peppercorn Beef Flambé).
 - c. Clean ventilating fans frequently. Grease should not be allowed to accumulate on fan or filter.
 - d. Use proper pan size. Always use cookware appropriate for the size of the surface element.
-

In the event that personal clothing or hair catches fire, drop and roll immediately to extinguish flames.

Have an appropriate fire extinguisher available, nearby, highly visible and easily accessible near the appliance. Smother flames from food fires other than grease fires with baking soda. Never use water on cooking fires.

WARNING

TO REDUCE THE RISK OF INJURY TO PERSONS IN THE EVENT OF A GREASE FIRE, OBSERVE THE FOLLOWING:

- a. SMOTHER FLAMES with a close-fitting lid, cookie sheet, or metal tray, then turn off the burner. BE CAREFUL TO PREVENT BURNS. If the flames do not go out immediately, EVACUATE AND CALL THE FIRE DEPARTMENT.
 - b. NEVER PICK UP A FLAMING PAN – You may be burned.
 - c. DO NOT USE WATER, including wet dishcloths or towels – a violent steam explosion will result.
 - d. Use an extinguisher ONLY if:
 - You know you have a Class ABC extinguisher, and you already know how to operate it.
 - The fire is small and contained in the area where it started.
 - The fire department is being called.
 - You can fight the fire with your back to an exit.
-

Whenever possible, do not operate the ventilation system during a cooktop fire. However, do not reach through fire to turn it off.

Cooking Safety

WARNING

Use this appliance only for its intended use as described in this manual. NEVER use this appliance as a space heater to heat or warm the room. Doing so may result in overheating the appliance. Never use the appliance for storage.

When using the timer, always supervise the cooktop and do not allow anything to boil over or burn. Boilovers can cause smoke and some foods and oils may catch fire if left on high temperature settings.

CAUTION

If the temperature sensing system is not working properly, boilovers may result causing burns and injury.

WHEN COOKING WITH THE COOKING SENSOR FUNCTION OBSERVE THE FOLLOWING:

- Always put the lid on pots
 - Always fill pots with at least 1 ¼" (3 cm) of liquid
 - Always use pots of the appropriate size and type (enamelware pots, stainless steel and aluminum pots equipped with wireless temperature sensor)
 - Always keep the sensor's window clean
-

IMPORTANT SAFETY INSTRUCTIONS

READ AND SAVE THESE INSTRUCTIONS

When using the Cooking Sensor mode, make sure that the selected cooking zone matches the one on which you have placed the cookware with the cooking sensor.

WARNING

RISK OF INJURY

The wireless cooking sensor is powered by a battery, which may become damaged if it is exposed to high temperatures. Remove the sensor from the cookware and store it away from any heat sources.

WARNING

RISK OF INJURY

The cooking sensor can be very hot when removing it from the cookware. Use potholders or a dish towel to remove it.

Never use the appliance if liquids or foods have spilled around the control panel. Always turn off the cooktop and dry the control panel.

Injury and damage to the appliance may occur if control elements are not used properly.

If the cooktop turns off automatically and can no longer be operated, it may turn itself on unintentionally at a later point. Switch off the circuit breaker in the fuse box. Contact Customer Support for service.

Burn Prevention

DO NOT TOUCH SURFACE UNITS OR AREAS NEAR UNITS - Surface units may be hot even though they are dark in color. Areas near surface units may become hot enough to cause burns. During and after use, do not touch, or let clothing, potholders, or other flammable materials contact surface units or areas near units until they have had sufficient time to cool. Among these areas are the cooktop and areas facing the cooktop.

Do not heat or warm unopened food containers. Build-up of pressure may cause the container to burst and cause injury.

Always use dry potholders. Moist or damp potholders on hot surfaces may result in burns from steam. Do not let potholder touch hot heating elements. Do not use a towel or other bulky cloth.

Always turn hood ON when cooking at high heat or when flambéing food (i.e. Crêpes Suzette, Cherries Jubilee, Peppercorn Beef Flambé).

Use high heat settings on the cooktop only when necessary. To avoid bubbling and splattering, heat oil slowly, on no more than a low-medium setting. Hot oil is capable of causing extreme burns and injury.

Never move a pan of hot oil, especially a deep fat fryer. Wait until it is cool.

Secure all loose garments, etc., before beginning. Tie long hair so that it does not hang loose, and do not wear loose-fitting clothing or hanging garments, such as ties, scarves, jewelry, or dangling sleeves.

WARNING

RISK OF BURNS

Metallic objects become hot very quickly on the cooktop. Never set down metallic objects such as knives, forks, spoons and lids on the cooktop.

WARNING

RISK OF BURNS

The pan detection shut-off feature may not turn off the cooking zone due to spilled food or objects placed on the cooktop.

If the display does not work when a cooking area is heating up, disconnect the circuit breaker or fuse in the electrical panel. Contact an authorized servicer.

Child Safety

When children become old enough to use the appliance, it is the responsibility of the parents or legal guardians to ensure that they are instructed in safe practices by qualified persons.

Do not allow anyone to climb, stand, lean, sit, or hang on any part of an appliance, especially a door, warming drawer, or storage drawer. This can damage the appliance, and the unit may tip over, potentially causing severe injury.

Do not allow children to use this appliance unless closely supervised by an adult. Children and pets should not be left alone or unattended in the area where the appliance is in use. They should never be allowed to play in its vicinity, whether or not the appliance is in use.

CAUTION

Items of interest to children should not be stored in an appliance, in cabinets above an appliance or on the backsplash. Children climbing on an appliance to reach items could be seriously injured.

Cleaning Safety

Do not clean the appliance while it is still hot. Some cleaners produce noxious fumes when applied to a hot surface. Wet clothes and sponges can cause burns from steam.

Do not use steam cleaners to clean the appliance.

IMPORTANT SAFETY INSTRUCTIONS

READ AND SAVE THESE INSTRUCTIONS

Cookware Safety

Hold the handle of the pan when stirring or turning food. This helps prevent spills and movement of the pan.

Use Proper Pan Size.

The use of undersized cookware will expose a portion of the heating element or burner to direct contact and may result in ignition of clothing. Select cookware having flat bottoms large enough to cover the surface heating unit. This appliance is equipped with one or more surface units of different sizes. Proper relationship of cookware to heating element or burner will also improve efficiency.

Cookware not approved for use with ceramic cooktops may break with sudden temperature changes. Use only pans that are appropriate for ceramic induction cooktops.

Always position handles of utensils inward so they do not extend over adjacent work areas, burners, or the edge of the cooktop. This reduces the risk of fires, spills and burns.

WARNING

RISK OF INJURY

When cooking with a double-boiler, the cooktop and cooking vessel may crack due to overheating. The cooking vessel in the double-boiler must not come in direct contact with the bottom of the pot filled with water. Use only heat-resistant cookware.

WARNING

DANGER OF INJURY

Cookware may jump upward due to fluid trapped between the cookware bottom and cooking zone. Always keep cooking zone and cookware bottom dry.

Proper Installation and Maintenance

Have the installer show you the location of the circuit breaker or fuse. Mark it for easy reference.

This appliance must be properly installed and grounded by a qualified technician. Connect only to properly grounded outlet. Refer to Installation Instructions for details.

This appliance is intended for use up to a maximum height of 13,100 feet (4,000 meters) above sea level.

This appliance is intended for normal family household use only. It is not approved for outdoor use. See the Statement of Limited Product Warranty. If you have any questions, contact the manufacturer.

Do not store or use corrosive chemicals, vapors, flammables or nonfood products on or near this appliance. It is specifically designed for use when heating or cooking food. The use of corrosive chemicals in heating or cleaning will damage the appliance and could result in injury.

Do not operate this appliance if it is not working properly, or if it has been damaged. Contact an authorized servicer.

Do not cook on a broken cooktop. Cleaning solutions and spillovers may create a risk of electric shock.

Do not repair or replace any part of the appliance unless specifically recommended in this manual. Refer all servicing to a factory authorized service center.

To avoid electrical shock hazard, before servicing the appliance, switch power off at the service panel and lock the panel to prevent the power from being switched on accidentally.

Electromagnetic interference

WARNING

This induction cooktop generates and uses ISM frequency energy that heats cookware by using an electromagnetic field. It has been tested and complies with Part 18 of the FCC Rules for ISM equipment. This induction cooktop meets the FCC requirements to minimize interference with other devices in residential installation. Induction cooktops may cause interference with television or radio reception. If interference occurs, the user should try to correct the interference by:

- Relocating the receiving antenna of the radio or television.
- Increasing the distance between the cooktop and the receiver.
- Connecting the receiver into an outlet different than the cooktop.

It is the user's responsibility to correct any interference.

CAUTION

Persons with a pacemaker or similar medical device should exercise caution when standing near an induction cooktop while it is in use. Consult your doctor or the manufacturer of the pacemaker or similar medical device for additional information about its effects with electromagnetic fields from an induction cooktop.

WARNING

HAZARD DUE TO MAGNETISM

The wireless temperature sensor is magnetic. The magnetic elements can damage electronic implants such as pacemakers or insulin pumps. People with electronic implants should therefore not put the temperature sensor in the pockets of their clothes and should maintain a minimum distance of 4" (10 cm) with respect to their pacemaker or similar medical device.

IMPORTANT SAFETY INSTRUCTIONS

READ AND SAVE THESE INSTRUCTIONS

Cooling fan

The cooktop is equipped with a cooling fan on its underside. Should the cooktop lie above a drawer, there must be no objects or paper in it. They may be sucked in and compromise the cooling of the appliance or damage the fan.

There must be a minimum distance of 3/4" (20mm) between the content of the drawer and the fan input.

Proposition 65 Warning:

This product may contain a chemical known to the State of California, which can cause cancer or reproductive harm. Therefore, the packaging of your product may bear the following label as required by California:

STATE OF CALIFORNIA PROPOSITION 65 WARNING:

 **WARNING**

Cancer and Reproductive Harm - www.P65Warnings.ca.gov

Causes of damage

NOTICE:

- Rough pot and pan bases scratch the cooktop.
- Never leave cookware cooking empty. This can cause damage.
- Do not place hot pots or pans on the control panel, the displays or the cooktop surround. This can cause damage.
- Damage can occur if hard or pointed objects fall on the cooktop.
- Aluminum foil and plastic containers can melt and stick on hot burners. The use of oven protective foil on the cooktop is not recommended.

Overview

You will find the most frequently caused damage in the following table.

Damage	Cause	Remedy
Stains	Boiled-over food.	Remove boiled-over food immediately with a glass scraper.
	Unsuitable cleaning agent.	Only use cleaning agents that are suitable for this type of cooktop.
Scratches	Salt, sugar and sand.	Do not use the cooktop as a work surface or storage space.
	Cookware with rough bases scratch the cooktop.	Check the cookware.
Discoloration	Unsuitable cleaning agent.	Only use cleaning agents that are suitable for this type of cooktop.
	Pan abrasion.	Lift pots and pans when moving them.
Blisters	Sugar, food with a high sugar content.	Remove boiled-over food immediately with a glass scraper.

Protecting the Environment

Energy-saving Advice

- Place a lid on cookware. Cooking with an uncovered pan will result in a considerable increase in energy use. Use a glass lid to provide visibility and avoid having to lift the lid.
- Use cookware equipped with a solid, flat bottom. Curved pan bases increase energy consumption.
- The diameter of the pan base must match the size of the element. Note: The manufacturer normally indicates the pan's upper diameter. This is normally greater than the diameter of the pan's base.
- Choose cookware of a size suited to the amount of food you are going to cook. A large pan that is only half full will use a lot of energy.
- Use a small amount of water when cooking. This saves energy, and vegetables retain a larger percentage of their vitamins and minerals.
- Select the lowest power level to maintain cooking. If the power level is too high, energy is wasted.

Cooking with Induction

Advantages of Induction Cooking

Induction cooking is fundamentally different from traditional cooking methods, as heat builds up directly in the cookware. This offers numerous advantages:

- Saves time when boiling and frying.
- Saves energy.
- Easier to care for and clean. Spilled food does not burn on as quickly.
- Heat control and safety – the cooktop increases or decreases the amount of heat supplied as soon as the user changes the setting. If the cookware is removed, the induction burner immediately interrupts the heat supply without it having been switched off.

Cookware

Only use ferromagnetic cookware for induction cooking, such as:

- Cookware made from enameled steel
- Cookware made from cast iron
- Special induction-compatible cookware made from stainless steel.

To find out whether your cookware is suitable for induction cooking, check whether a magnet is attracted to the base of the item or refer to the manufacturer's specifications.

Some induction cookware does not have a fully ferromagnetic base:

- If the base of the cookware is only partially ferromagnetic, only the area that is ferromagnetic will heat up. This may mean that heat will not be distributed evenly. The non-ferromagnetic area may not heat up to a sufficient temperature for cooking.

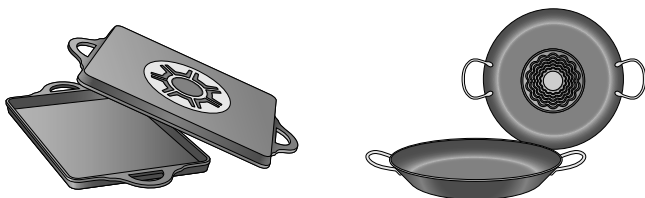

- The ferromagnetic area will also be reduced if the material from which the base of the cookware is made contains aluminum, for example. This may mean that the cookware will not become sufficiently hot or even that it will not be detected.

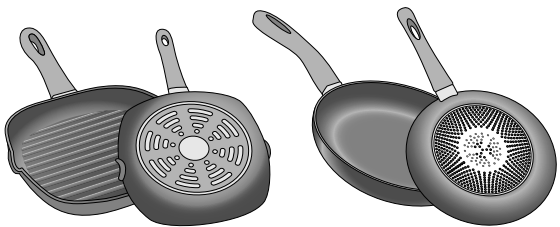

Unsuitable cookware

Do not ever use adapter plates for induction or cookware made of:

- Traditional stainless steel
- Glass
- Clay
- Copper
- Aluminum

Properties of the base of the cookware

The properties of the base of the cookware can affect the cooking result. Cookware made of materials that distribute heat evenly, such as saucepans with a stainless steel sandwich base, save time and energy.

Cookware with a completely flat base works best. If the base of the cookware is uneven or embossed, this will reduce the heat supplied.

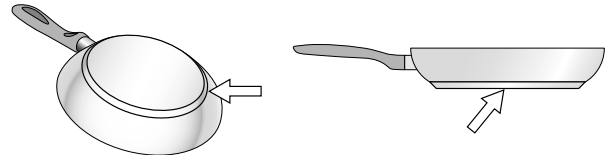

No cookware/cookware of an unsuitable size

Always place cookware inside the usable area of the cooking surface. If the cookware is not positioned correctly, is made of an unsuitable material or is not the right size, the Δ symbol appears next to the cooking zone display. Move the cookware or try again with a different pot or pan.

If the active cookware is lifted from the cooking surface for longer than 30 seconds, the cooking zone automatically switches off.

Empty cookware or cookware with a thin base

Do not heat empty cookware and do not use cookware that has a thin base. The cooktop is equipped with an internal safety system. However, an empty item of cookware can heat up so quickly that the automatic switch-off function has no time to react and an excessively high temperature is reached. This could melt the base of the cookware and damage the glass plate. If this happens, switch off the cooktop and do not touch the cookware. If the cooktop no longer works once it has cooled down, contact Customer Support.

Pot detection

The cooktop uses the ferromagnetic diameter and material of the base of the cookware to automatically detect the position, size and shape of the cookware being used. Cookware with a base measuring 3½" to 13½" (90 to 340 mm) in diameter is suitable for use.

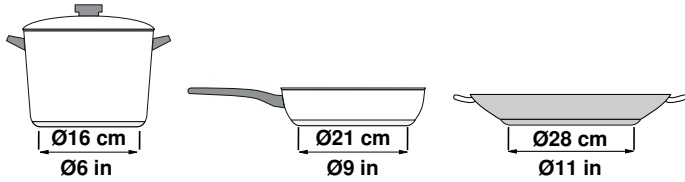

Note: The cooking zone displays may show a size and shape that is different from the cookware actually being used. This is normal and does not affect the functioning of the hob. For more information, see the section entitled → "Frequently-asked questions and answers (FAQ)".

Familiarizing yourself with your appliance

This section explains how to use the cooking surface, the control panel and the various functions of the appliance.

Cooking surface

The entire cooking surface of the cooktop supplies induction heating. You can place cookware anywhere inside the usable area of the cooking surface. The position, size and shape of the cookware will be detected automatically.

Note: Up to five items of cookware can be heated at the same time on the cooking surface.

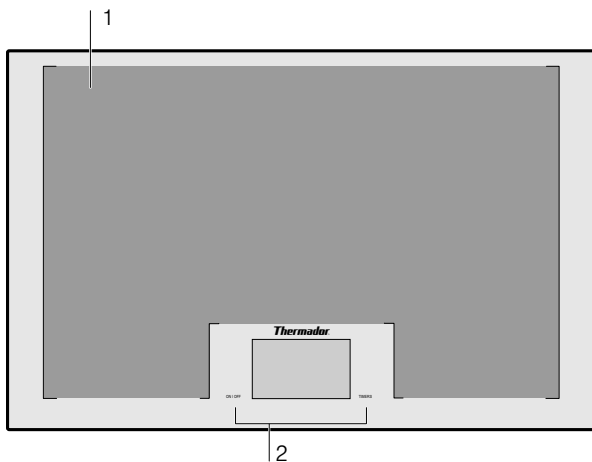

Cooktop

- 1 Usable cooking surface
- 2 Control panel

The control panel

The control panel has touch buttons and a touchscreen display.

Buttons

The buttons are touch-sensitive. To select a function, touch the relevant symbol. The available functions will appear on the display.

Notes







- Always keep the control panel clean and dry. Moisture can prevent it from working properly.
- Never place hot cookware on the touchscreen display. There is a risk that the electronics will overheat.



Touch buttons

ON OFF	Main switch
TIMERS	Timer menu
	Kitchen Timer
	Stopwatch Timer
	Panel Lock
	Pause function
	Cooktop - Hood Sync
	Basic settings
	Detected cooking position
1.0 - 9.0	Power levels
	PowerBoost® function
	PanBoost™ function

Touch buttons

	Keep Warm function
	Cook timer
	Cookware mode
	MyZone™
	Standard cooking mode
	Cooking Sensor mode
	TeppanyakiPro™

Touchscreen display

The touchscreen display gives you an overview of the cookware on the cooking surface and the buttons for activating the various functions.

When an item of cookware is placed on the cooking surface, the cooking position for this cookware is shown on the display.

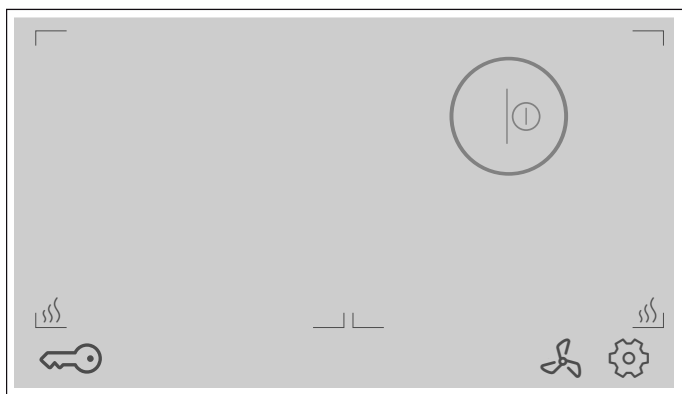

Overview of the Menus

The intuitive menu structure helps you to find your way around the control panel of your cooktop. You can find out more about the most important menus in this section.





Main screen

The main display provides an overview of the indicators for the cookware on the cooking surface. It displays the cooking mode, power levels, and the timer functions that are set for the cooking positions that are switched on.

Function bar

The function bar provides access to a number of functions and other menus.

The following options are shown in the function bar:

-  Panel Lock
-  Pause function
-  Cooktop - Hood Sync
-  Basic Settings

Info menu

The info menu provides you with information about the appliance or the functions that are currently active.

To access the info menu, touch the  symbol on the function bar. The sensor will show when the function is available.

Notifications and alerts

Notifications let you know that the appliance's status has changed or that you need to confirm something.

To return to the main screen, touch the  symbol.

Note: The top line of the display lights up blue.





Alerts let you know that you need to do something.

Follow the instructions in the display and touch the  symbol to return to the main screen.

Note: The top line of the display lights up red.

Cookware mode menu

The cooktop has various functions for the cooking positions.

Cookware mode	Function
 MyZone™	This enables a particular power level to be controlled according to the position of the cookware, i.e. by moving it from front to back across the cooking surface.
 Standard cooking mode	This enables a power level to be chosen for each item of cookware.
 Cooking Sensor	You can use the cooking sensor attached to the outside of the cookware to maintain the temperature automatically. These cooking functions are designed for foods that need to be cooked with a lot of water or fried with a lot of oil/fat in a pot.
 TeppanyakiPro™	This enables the Teppanyaki-Pro™ surface to be divided into two sections. This means you can cook food on one section and keep food warm on the other section, or use the entire area to cook food at the same power level.

To access the cookware mode menu, touch the cooking position display and then the  touch button.

Cooking Position Display

When you place cookware on the cooking surface, the indicator for the relevant cooking position will light up on the touchscreen display.

Detected cooking position

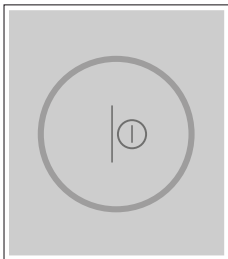

The cookware on the cooking surface has been detected. The cooking position display lights up. Touch the ① symbol to select the cooking position.

Selected cooking position



The indicated cooking position has been selected. You can now set the power level.

Cooking position switched on



The indicated cooking position has been switched on. The selected power level lights up in the display.

There is no cookware on the cooking position



The cookware has been removed from the cooking position. The selected power level is dimmed.

Other displays and symbols



The settings for the cooking position cannot be configured.

Touch the display for more information.

Possible causes:

- Up to 5 items of cookware evenly distributed over the cooking surface can be heated at the same time.
- The cookware is not suitable for use on an induction cooktop.
- The appliance has exceeded its maximum power consumption.

Residual Heat Indicator

The cooktop has several residual heat indicators «}» to warn you that one or more cooking positions is/are still hot. One, two or all three bars of the indicator «}» will light up depending on how strong the residual heat is. Do not touch the cooking surface while the indicators are still lit or immediately after they have switched off.

When you switch off the cooktop the residual heat indicators will remain lit for as long as the cooking surface is still hot.

Operating the Appliance

This chapter explains how to set a cooking position. The table shows heat settings and cooking times for various meals.

First-time use

When you switch on the appliance for the first time, the menu for selecting the initial settings appears on the display. Select the settings you require.

Once you have confirmed these settings, the main screen will appear.

Note: You can change the settings at any time. For information on how to select these settings, see the section entitled → "Basic Settings".

Switching the cooktop on and off

Use the main switch to switch the cooktop on and off.

Switch on: Touch the ON | OFF button. The indicator above the main switch will light up. After a short time, the cooktop will be ready for operation.

Switch off: Touch the ON | OFF button. The indicator will switch off. All cooking positions are switched off.

The residual heat indicator will remain lit until the cooking positions have cooled down sufficiently.

Notes

- The cooktop switches off automatically if the cooking positions have been switched off for more than 30 seconds.
- The selected settings will be stored for 10 minutes after the cooktop has been switched off. If you switch the cooktop back on during this time, the option to confirm the previous settings appears on the main screen. For information on this setting, see the section entitled → "Basic Settings"

Setting a cooking position

The required power level is selected in the settings area.

Power level 1.0	= lowest setting
Power level 9.0	= highest setting

Each power level has an intermediate level, which is marked with .5.

Notes

- To protect the fragile parts of your appliance from overheating and electrical overloading, the cooktop may temporarily reduce the power automatically.
- In order to prevent the appliance from producing excess noise, the cooktop may temporarily reduce the power automatically.

Selecting a cooking position and power level

The cooktop must be switched on.

1. Place the cookware on the cooking surface.
2. Touch the  symbol for the cooking position on the touchscreen display. The settings area will light up on the cooking position display.

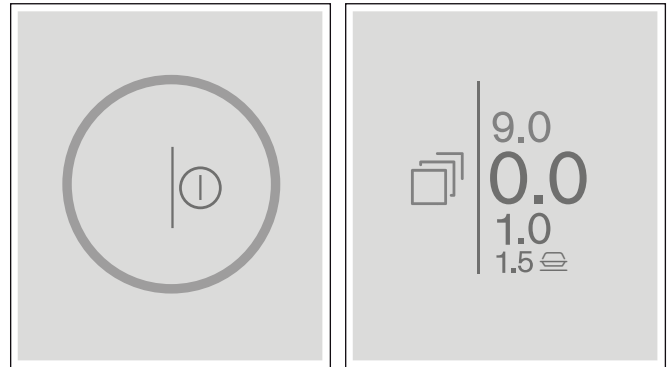

3. Within the next 4 seconds, scroll up with your finger and select the power level you require. To select power level 9.0, tap 9.0 directly.

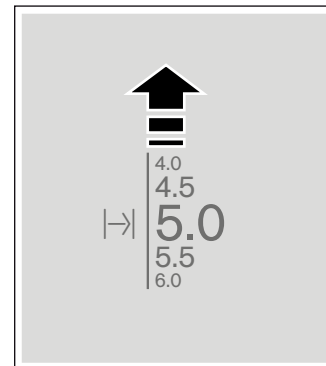

The power level is set.

Changing the power level

Select the cooking position and then select the required power level in the settings area.

Switching off a cooking position

Touch and hold the cooking position display until power level **0.0** is displayed in the settings area. The cooking position will switch off.

Note: If you place cookware on the cooking surface before switching on the cooktop, this will be detected when you touch the main switch, and the indicator for the cooking position will appear on the touchscreen display.

Chef's recommendations

Recommendations

- Stir occasionally when heating up purees, creamy soups and thick sauces.
- For preheating, select heat setting 8 or 9.
- When cooking with the lid on, turn the heat setting down as soon as steam starts to escape from between the lid and the cookware.
- After cooking, keep the lid on the cookware until you serve the food.
- To cook with the pressure cooker, follow the manufacturer's instructions.
- Do not cook food for too long, otherwise nutrients will be lost. The kitchen timer can be used to set the optimum cooking time.
- For healthier cooking results, oils and fats should not be heated to their smoke point.
- To brown food, fry small portions one after the other.
- Cookware may reach high temperatures while the food is cooking. We recommend that you use pot holders.
- You can find recommendations for energy-efficient cooking in the section entitled → *"Cooking with Induction"*

Cooking table

The table shows which heat setting is suitable for each type of food. The cooking time may vary depending on the type, weight, thickness and quality of the food.

	Ongoing cooking setting	Time (min)
Melting		
Chocolate, couverture	1.0 - 1.5	-
Butter, honey, gelatin	1.0 - 2.0	-
Heating or keeping warm		
Stew, e.g. lentil stew	1.5 - 2.0	-
Milk ¹	1.5 - 2.5	-
Heating sausages in water ¹	3.0 - 4.0	-
Defrosting and heating		
Spinach, frozen	3.0 - 4.0	15 - 25
Goulash, frozen	3.0 - 4.0	35 - 55
Poaching, simmering		
Potato dumplings ¹	4.5 - 5.5	20 - 30
Fish ¹	4.0 - 5.0	10 - 15
White sauces, e.g. Béchamel sauce	1.0 - 2.0	3 - 6
Whisked sauces, e.g. Béarnaise sauce, Hollandaise sauce	3.0 - 4.0	8 - 12
Boiling, steaming, braising		
Rice (with double the volume of water)	2.5 - 3.5	15 - 30
Rice pudding ³	2.0 - 3.0	30 - 40
Unpeeled boiled potatoes	4.5 - 5.5	25 - 35
Boiled potatoes	4.5 - 5.5	15 - 30
Pasta ¹	6.0 - 7.0	6 - 10
Stew	3.5 - 4.5	120 - 180
Soups	3.5 - 4.5	15 - 60
Vegetables	2.5 - 3.5	10 - 20
Vegetables, frozen	3.5 - 4.5	7 - 20
Stew in a pressure cooker	4.5 - 5.5	-

¹ Without lid

² Turn several times

³ Preheat at level 8.0 - 8.5

	Ongoing cooking setting	Time (min)
Braising		
Rolled roasting joint	4.0 - 5.0	50 - 65
Pot roast	4.0 - 5.0	60 - 100
Goulash ³	3.0 - 4.0	50 - 60
Braising/frying with a small amount of oil ¹		
Schnitzel, plain or breaded	6.0 - 7.0	6 - 10
Schnitzel, frozen	6.0 - 7.0	6 - 12
Chops, plain or breaded ²	6.0 - 7.0	6 - 12
Steak (1¼" (3 cm) thick)	7.0 - 8.0	6 - 12
Poultry breast (¾" (2 cm) thick) ²	5.0 - 6.0	10 - 20
Poultry breast, frozen ²	5.0 - 6.0	10 - 30
Rissoles (1¼" (3 cm) thick) ²	4.5 - 5.5	20 - 30
Hamburgers (¾" (2 cm) thick) ²	6.0 - 7.0	10 - 20
Fish and fish fillet, plain	5.0 - 6.0	8 - 20
Fish and fish fillet, breaded	6.0 - 7.0	8 - 20
Fish, breaded and frozen, e.g. fish sticks	6.0 - 7.0	8 - 15
Prawns and scampi	7.0 - 8.0	4 - 10
Sautéing fresh vegetables and mushrooms	7.0 - 8.0	10 - 20
Asian stir fries (vegetables and pieces of meat)	7.0 - 8.0	15 - 50
Stir fries, frozen	6.5 - 7.5	6 - 10
Pancakes (cooked one after the other)	6.5 - 7.5	-
Omelette (cooked one after the other)	3.5 - 4.5	3 - 10
Fried eggs	5.0 - 6.0	3 - 6
Deep fat frying¹		
[5 - 7 oz (150-200 g) per portion in 2 - 4 pints (1-2 liters) oil, fried in portions]		
Frozen products, e.g. fries, chicken nuggets	8.0 - 9.0	-
Croquettes, frozen	7.0 - 8.0	-
Meat, e.g. chicken portions	6.0 - 7.0	-
Fish, breaded	6.0 - 7.0	-
Vegetables, mushrooms, breaded, or tempura	6.0 - 7.0	-
Small baked items, e.g. doughnuts	5.5 - 6.5	-

¹ Without lid

² Turn several times

³ Preheat at level 8.0 - 8.5

Timer functions

The cooktop has three timer functions:

- Cook timer
- Stopwatch timer
- Kitchen timer

Cook Timer

The cooking position will switch off automatically once the time that is set has elapsed.

You can set a cooking time of up to 12 hours 59 minutes.

Setting the Cook Timer

1. Select the cooking position and the required power level.
2. Touch the selected power level. The \rightarrow symbol will light up in the cooking position display.
3. Touch the \rightarrow symbol. **00|00** h_{min} will light up on the cooking position display.

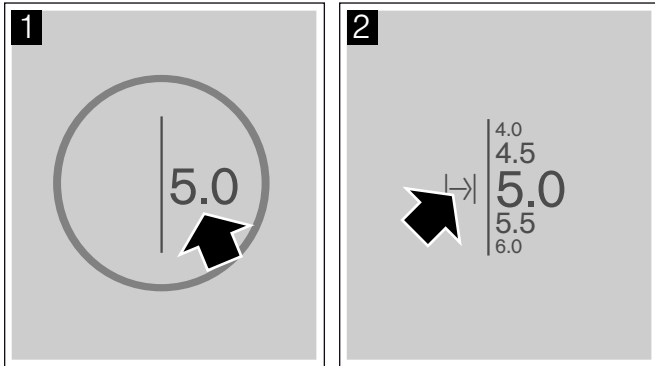

4. Then select the required cooking time in hours and minutes.

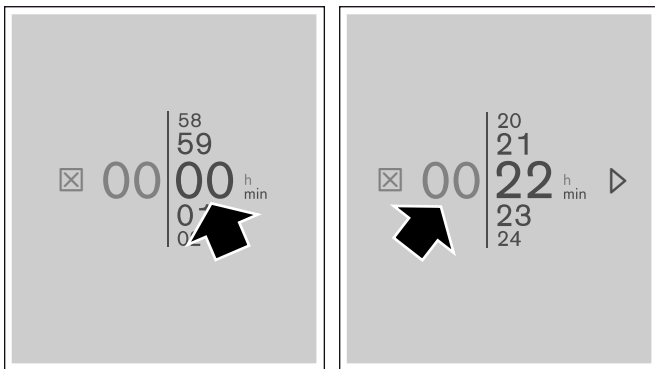

5. Touch the \triangleright symbol to confirm the selected time. The time you have set will appear in the cooking position display.

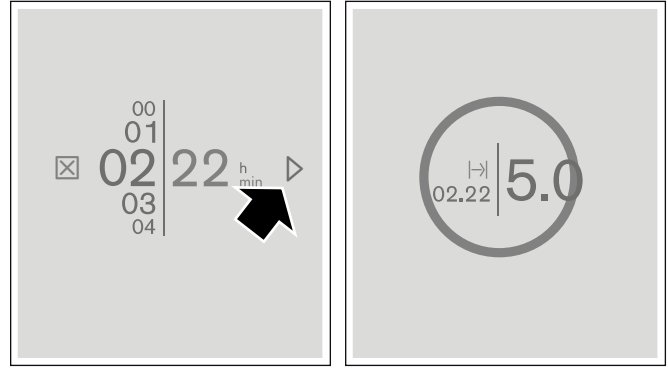

The cooking time begins to elapse.

Cooking Sensor mode

If a cooking time has been set for a cooking position and Cooking Sensor mode is active, the time will not start to count down until the selected temperature has been reached.

Changing or deleting the time

Select the \rightarrow symbol.

Change the time that is currently set and then touch the \triangleright symbol to confirm your chosen setting.

To delete the time, touch the \boxtimes symbol.

When the time has elapsed

The cooking position will switch off. A signal will sound. The set cooking time will be **00.00** and the power level at **0.0**.

Touch the time display. The indicators will switch off and the audible signal will stop.

Stopwatch Timer

The Stopwatch Timer timer function displays the time that has elapsed since activation.

This functions runs independently from the cooking positions and from other settings. This function does not automatically switch off a cooking position.



Activating the Stopwatch Timer

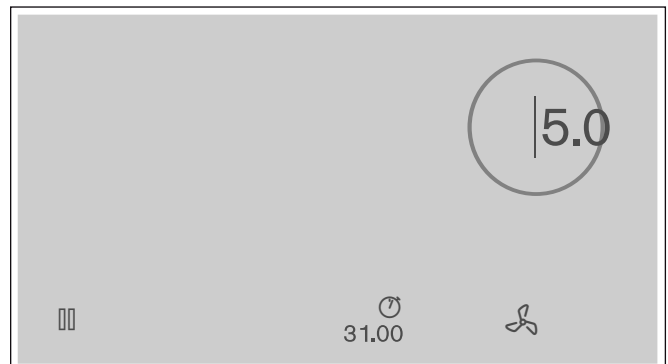

Touch the TIMERS touch button and select the ⌚ symbol. Then touch the \triangleright symbol to confirm your choice. **00.00** and the ⌚ symbol will light up in the function bar.





The Stopwatch Timer has now been activated. The time will begin to elapse.

Pausing the Stopwatch Timer

Touch the  symbol followed by the  symbol. The Stopwatch Timer will pause and reappear on the main screen.

To start the Stopwatch Timer again, touch the  symbol followed by the  symbol.

Deactivating

Touch the  symbol followed by the  symbol. The Stopwatch Timer will stop. The time will reset to **00.00** and reappear on the main screen.

The function has now been deactivated.

Note: To clear the menu and return to the main screen, touch the  symbol.



Kitchen Timer

You can set a time of up to 9 hours, 59 minutes and 59 seconds on the Kitchen Timer.



You can activate it whether the cooktop is switched on or off.

It works independently of the cooking positions and other settings. This function does not automatically switch off a cooking position.

Setting the Kitchen Timer

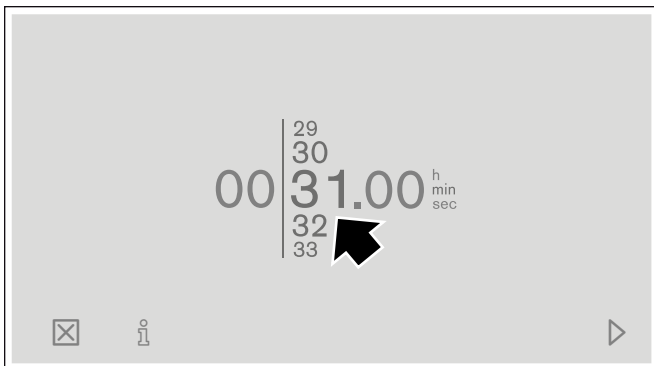
1. Touch the TIMERS touch button.
2. Touch the  symbol and confirm your choice by touching the  symbol. **00 | 00.00^{h min sec}** will light up in the display.
3. Within the next 10 seconds, scroll up or down with your finger and set the time in minutes, hours and seconds.



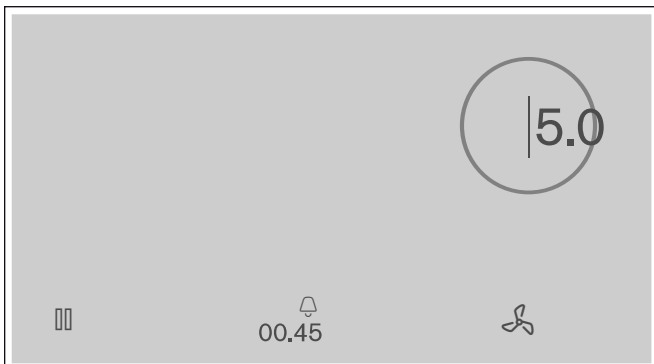

4. Touch the  symbol to confirm your chosen setting. The  symbol and the selected time will light up in the function bar.



The selected time will start to count down.



Changing or deleting the time



Touch the  symbol.

Change the time that is currently set and touch the  symbol to confirm your chosen setting.

To delete the time, touch the  symbol.

Pausing the Kitchen Timer

Touch the  symbol followed by the  symbol. The Kitchen Timer will pause and reappear on the main screen.

To start the timer again, touch the  symbol followed by the  symbol.

When the time has elapsed

An audible signal will sound. **00.00** will flash in the timer display.

Touch the  symbol. The indicators will switch off and the audible signal will stop.

Touching and holding the  symbol for a few seconds will activate the Stopwatch Timer. The time that has elapsed is shown on the display after the **+** symbol.

If you do not touch the  symbol after the time has elapsed, the Stopwatch Timer will be activated automatically after a few seconds.

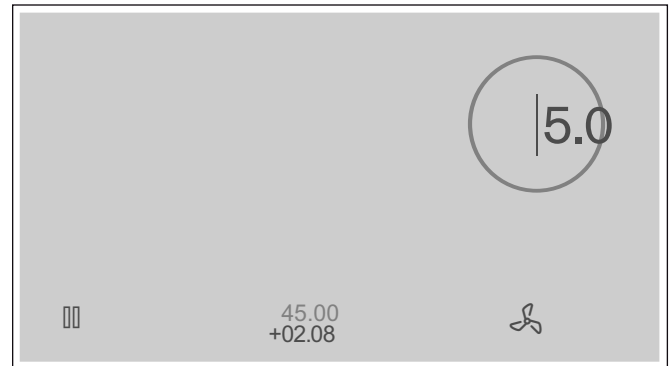

To set a new time on the Kitchen Timer, tap the time indicator.

If you touch and hold the time indicator for a few seconds, the time information on the display will go out.

PowerBoost® Function

The PowerBoost® function enables you to heat up large quantities of water more quickly than with power level 9.0.

This function is available if the  symbol is displayed in the settings area for the cookware.

The PowerBoost® function is only available for one saucepan on each side of the cooking surface.



If the PowerBoost® function is activated and you choose a second cooking position on the same side of the cooking surface, the PowerBoost® function will be deactivated. The cooking position is automatically set to power level 9.0.

If the PowerBoost® function in the center of the cooking surface is active, settings can be implemented for other items of cookware on the left- and right-hand side of the cooktop.

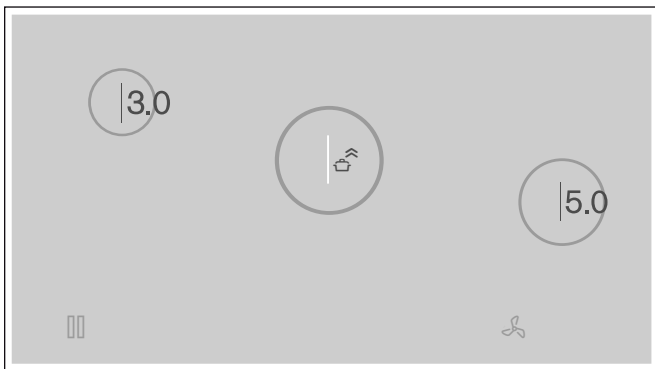

Activating

Select the cooking position and scroll up with your finger until the  symbol appears.

The function has now been activated.

Deactivating

Touch the cooking position display and select any power level in the settings area.

The function has now been deactivated.

Note: Under certain circumstances, the function will switch off automatically to protect the electronic components inside the cooktop.

The cooking position will automatically switch back to power level 9.0.

PanBoost™ Function

The PanBoost™ function can be used to heat pans more quickly than with power level 9.0.

After deactivating the function, select the appropriate power level for your food.

This function is available if the  symbol is displayed in the settings area for the cookware.

The PanBoost™ function is only available for one item of cookware per cooking surface.



If the PanBoost™ function is activated and the settings for a different cooking position on the same side of the cooking surface are selected, the PanBoost™ function will be deactivated and power level 9.0 set automatically.

If the PanBoost™ function for frying pans in the center of the cooking surface is active, settings can be implemented for other items of cookware on the left- and right-hand side of the cooktop.



Recommendations for use

- Always use cookware that has not been preheated.
- Use cookware with a fully flat base. Do not use cookware with a thin base.
- Never leave empty cookware, oil, butter or lard unattended when it is being heated.
- Do not place a lid on the cookware.
- For information on the type, size and positioning of the cookware, see the section entitled → "Basic Settings"

Activating

Touch the cooking position display and select the  symbol in the settings area.

The function has now been activated.

Deactivating

Touch the cooking position display and select any power level in the settings area.

The function has now been deactivated.

Note: After 30 seconds, this function will automatically switch itself off.

The cooking position will automatically switch back to power level 9.0.

Keep Warm

This function is suitable for melting chocolate or butter and for keeping food warm.

Activating

Select the relevant cooking position and then set the power level to **1.5**  in the settings area.

Deactivating

Touch the cooking position display and select any power level in the settings area.

The function has now been deactivated.

Transfer function

This function lets you transfer the selected power level or temperature setting and the cooking time from one cooking position to another.

If you remove an item of cookware from the cooking surface or move it, the cooking position it was previously on stops heating. The settings for the cooking position will be retained for 30 seconds.

When you place the cookware back in this position, the same settings will be used.

Activation

1. Place an item of cookware on the new cooking surface.

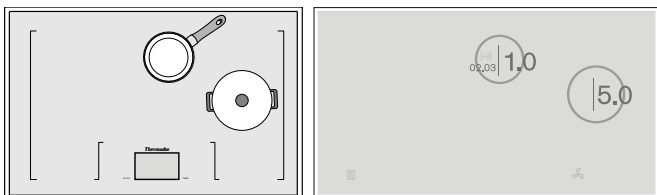

The  symbol will appear on the new cooking position.

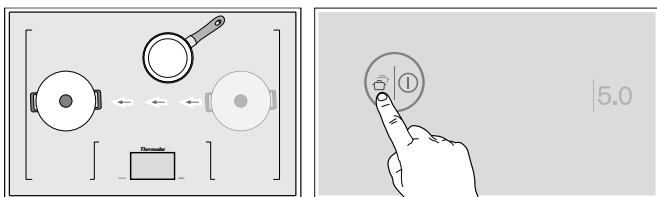

2. Touch the  symbol on the new cooking position to confirm transfer of the settings. The power level will light up.

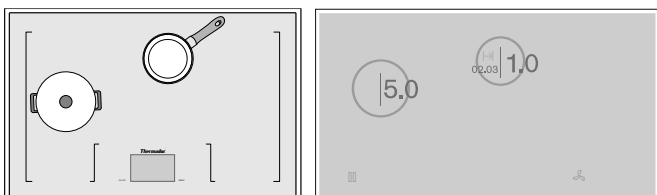

The settings have now been transferred to the new cooking position.

Wireless Cooking Sensor

Cooking Sensor mode ready (Wireless Cooking Sensor sold separately)

You will need to connect the wireless cooking sensor to the cooktop before using Cooking Sensor mode for the first time.

Preparing and caring for the wireless cooking sensor

This section provides information on:

- Attaching the silicone patch
- Attaching the wireless cooking sensor
- Cleaning
- Changing the battery

Silicone patches and cooking sensors can be purchased from the THERMADOR® eShop or by Customer Support. Order the relevant reference number:

00577921	Set of 5 silicone patches
TCOOK-SENSW	Cooking sensor and set of 5 silicone patches

Gluing on the silicone patch

The silicone patch secures the cooking sensor to the cookware.

When using a piece of cookware with Cooking Sensor mode for the first time, the silicone patch must be attached directly to this piece of cookware. Proceed as follows:

1. The part of the cookware to which the patch is to be adhered must be free of grease. Clean the pan, dry it thoroughly and wipe the area where the patch is to be adhered with an all purpose degreasing agent.
2. Remove the protective film from the silicone patch. Adhere the silicone patch in the correct place on the outside of the pot using the supplied template as a guide.

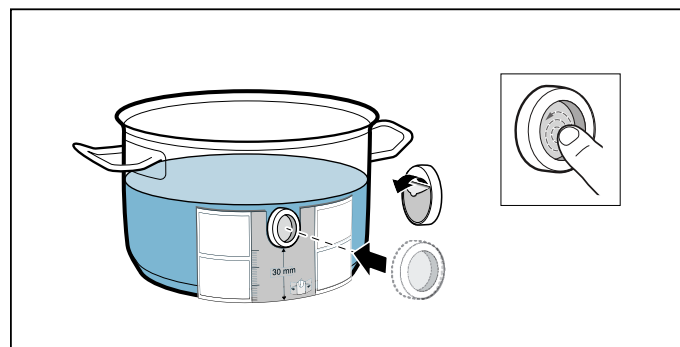

3. Press down all over the surface of the silicone patch, including in the center.

The adhesive requires 1 hour to fully cure. Do not use or clean the pot during this time.

Notes

- Do not leave the pot with the silicone patch to soak in soapy water for long periods of time.
- If the silicone patch comes off, replace it with a new one.

Attaching the wireless cooking sensor

Place the cooking sensor squarely onto the silicone patch.

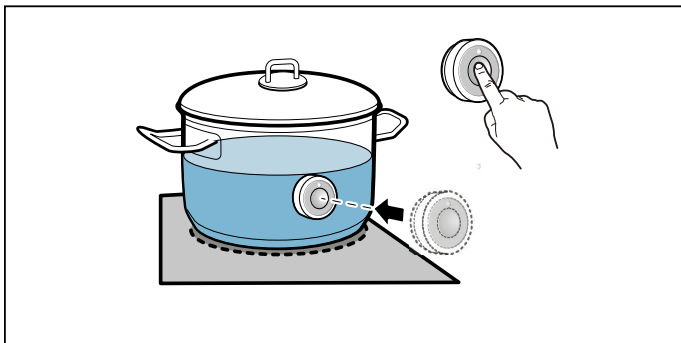







Notes

- Make sure that the silicone patch is completely dry before attaching the cooking sensor.
- Fill the pan so that the contents reach high enough to cover the cooking sensor's silicone patch.
- To prevent overheating, do not attach the cooking sensor to other hot cookware.
- Remove the cooking sensor from the saucepan after cooking. Store it in a clean, safe place away from sources of heat.
- You can use up to three cooking sensors at the same time.

Connecting the wireless cooking sensor to the control panel

To connect the wireless cooking sensor to the control panel, follow the instructions below:

1. Touch the  symbol on the main screen.
2. Select the *Cooking sensor pairing* option and then touch the  symbol to confirm.
3. Briefly touch the  symbol on the wireless cooking sensor within the next 30 seconds.
After a few seconds, the result of the connection between the cooking sensor and the control panel will appear on the display.
Then touch the  symbol to confirm.
4. To connect a different cooking sensor, touch the  symbol. To return to the basic settings, touch the  symbol.

The Cooking Sensor mode is made available once the cooking sensor has been connected to the control panel correctly.

Notes

- If there is a fault with the cooking sensor, the connection may not be established correctly for the following reasons:
 - Bluetooth® communication error.
 - The symbol on the cooking sensor was not pressed within 30 seconds.
 - The battery in the cooking sensor no longer has a charge.

Reset the cooking sensor and repeat the connection procedure.

- If there are problems with the connection due to a transmission error, repeat the connection procedure.

If the display continues to indicate a connection error, contact Customer Support.

Resetting the wireless cooking sensor

1. Touch and hold the  symbol on the cooking sensor for 8-10 seconds.

While you are doing this, the cooking sensor's LED indicator will light up three times. When the LED lights up for the third time, it will start to reset the cooking sensor. Take your finger off the symbol when this happens.

When the LED switches off, this means that the wireless cooking sensor has been reset.

2. Repeat the connection procedure.

Cleaning

Do not clean the wireless cooking sensor in the dishwasher.

Wireless cooking sensor

Clean with a damp cloth. Never put in the dishwasher, never get wet.

If the wireless cooking sensor is not used, remove it from the cookware and keep it in a clean, safe place and not near heat sources.

Silicone patch

Clean and dry before attaching to the wireless cooking sensor. Suitable for dishwashers.

Note: Do not leave utensils with the silicone patch in soapy water for long periods of time.

Cooking sensor window

The sensor window must always be clean and dry. Proceed as follows:

- Remove dirt and oil splatters regularly.
- For cleaning, use a soft cloth or Q-tips and window cleaner.

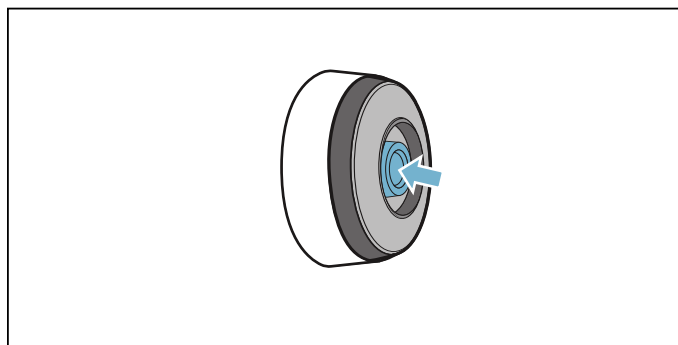

Notes

- Do not use abrasive cleaning products such as scouring pads, scrubbing brushes or cream cleaners.
- Do not touch the sensor window with your fingers. This may make it dirty or scratch it.

Replacing the battery

If the cooking sensor does not light up when the symbol is pressed, the battery no longer has a charge.

Replacing the battery:

1. Remove the silicone cover from the lower section of the cooking sensor casing and remove both screws using a screwdriver.

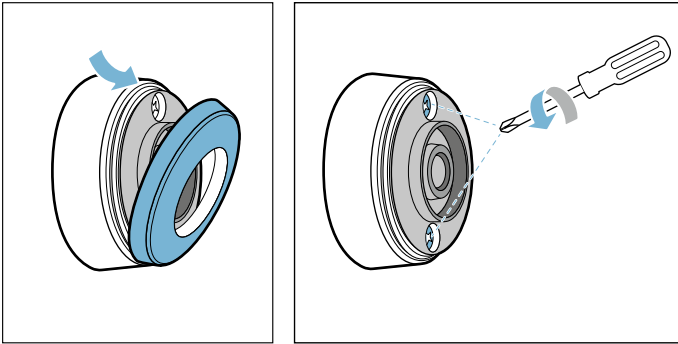

2. Open the cap on the cooking sensor. Remove the battery from the lower section of the casing and insert a new battery (make sure that the battery terminals (+/-) are the right way round).

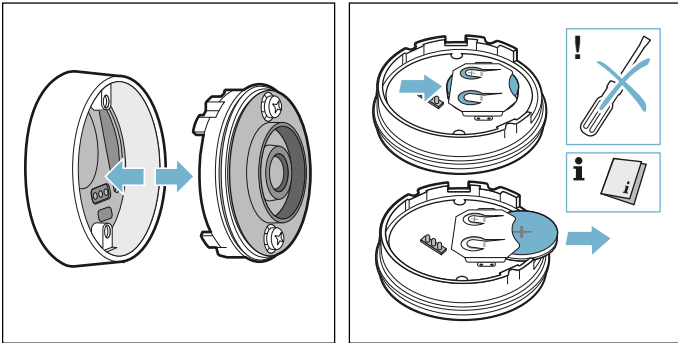

⚠ CAUTION

Do not use metal objects to remove the battery.
Do not touch the battery terminals.

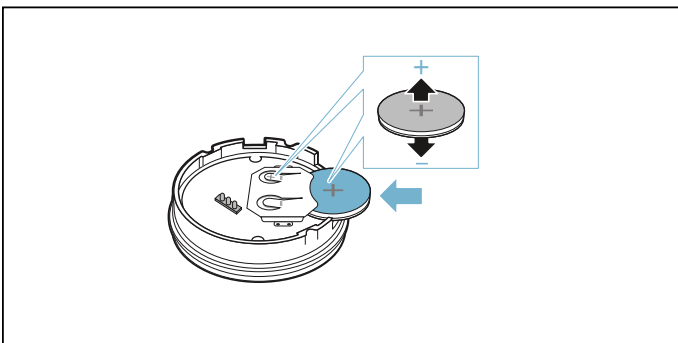

3. Close the cap on the cooking sensor (the indentations for the screws on the cap must be aligned with the indentations on the lower section of the casing). Tighten the screws with a screwdriver.

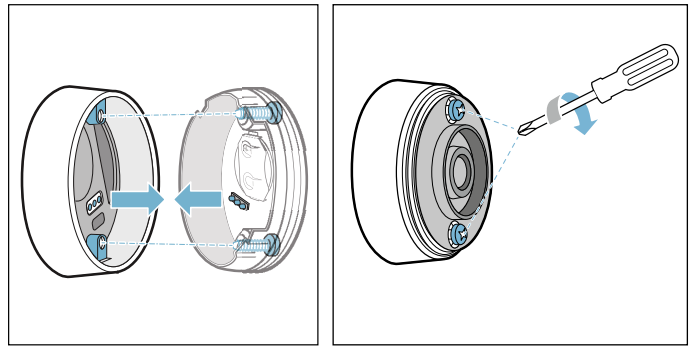

4. Put the silicone cover back on the lower section of the cooking sensor casing.

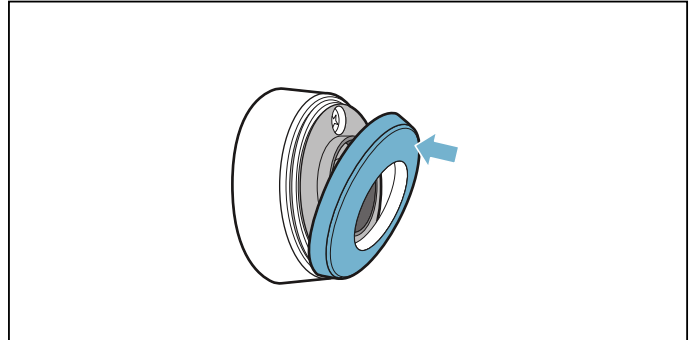

Note: Use only high-quality CR2032 batteries in order to maintain a long service life.

Declaration of Conformity

The logos and the Bluetooth® brand are registered trademarks and property of Bluetooth SIG, Inc. These trademarks are used by BSH Home Appliances Corporation under license. All other trademarks and brand names are owned by the respective companies.

This device complies with part 15 of the FCC Rules. Operation is subject to the following two conditions:

1. this device may not cause interference, and
2. this device must accept any interference, including interference that may cause undesired operation of the device.

Modifications not expressly approved by this company could void the user's authority to operate the equipment.

Note: This equipment has been tested and found to comply with the limits for a **Class B digital device**, pursuant to Part 15 of the FCC Rules. These limits are designed to provide reasonable protection against harmful interference in a residential installation. This equipment generates, uses and can radiate radio frequency energy and, if not installed and used in accordance with the instructions, may cause harmful interference to radio communications. However, there is no guarantee that interference will not occur in a particular installation. If this equipment does cause harmful interference to radio or television reception, which can be determined by turning the equipment off and on, the user is encouraged to try to correct the interference by one or more of the following measures:

- Reorient or relocate the receiving antenna.
- Increase the separation between the equipment and receiver.

- Connect the equipment into an outlet on a circuit different from that to which the receiver is connected.
- Consult the dealer or an experienced radio/TV technician for help.

This device and its antenna must not be co-located or operating in conjunction with any other antenna or transmitter.





Cooking Sensor Mode

The cooking sensor processes make cooking easy and produce exceptional results.

The wireless cooking sensor measures the temperature of the cookware continuously. This enables the cooking power to be controlled and the right temperature to be maintained at all times. This in turn prevents overheating and ensures perfect results.

Cooking processes with the cooking sensor

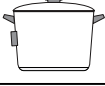
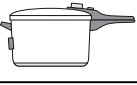
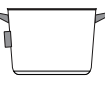
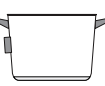
Cooking Sensor mode is used to select the best cooking method for each kind of food.

Cooking processes	Temperature °F (°C)	Cookware	Suitable for
Keeping warm, heating	155 (70)		E.g. punch, goulash
Simmering in milk	185 (85)		E.g. panna cotta, rice pudding
Simmering in water	195 (90)		E.g. potato dumplings, rice, quinoa
Boiling	212 (100)		E.g. pasta, gnocchi, vegetables
Cooking in a pressure cooker	240 (115)		E.g. home-made broths, legumes
Deep fat frying at a low temperature*	320 (160)		E.g. donuts, fritters
Deep fat frying at a medium temperature*	340 (170)		E.g. breaded fish, dumplings
Deep fat frying at a high temperature*	350 (180)		E.g. frozen French fries

*Heat oil with the lid on and fry with the lid off.

Advantages

- The cooking position is only powered when this is necessary to maintain the temperature. This saves energy.
- The temperature is maintained continuously. This prevents the food from boiling over. It also means that you do not have to change the temperature setting.
- Cooking Sensor mode will tell you when the water or oil has reached the optimal temperature for adding the

You can add your food once the selected temperature has been reached. The temperature is maintained without you having to change the power level.

Provided there is a wireless cooking sensor, Cooking Sensor mode is available over the entire cooking surface.

The wireless cooking sensor forwards information about the temperature of the cookware to the control panel.

You will need a wireless cooking sensor in order to use the cooking sensor function.

Cooking sensors (TCOOKSENSW) and additional silicon patches (00577921) can be purchased from the THERMADOR® eShop or by contacting Customer Support.

You can use up to three cooking sensors at the same time.

For more information about the cooking sensor, see the section entitled → "Wireless Cooking Sensor"

The table shows the different cooking processes that are available:

food (see the exceptions where the food should be added at the very beginning).

Notes

- Use pots or cookware with a thick, flat base. Do not use pots with a thin or deformed base.
- Fill the pot so that the contents reach high enough to cover the cooking sensor's silicone patch.

- Do not remove the cooking sensor from the pot during cooking.
- Remove the cooking sensor from the pot after cooking. Be careful as the cooking sensor may be very hot.

Tips for cooking with Cooking Sensor mode

- Keeping warm/heating: Suitable for portions of frozen products, e.g. spinach. Place the frozen product in the cookware. Add the volume of water specified by the manufacturer. Cover the cookware with a lid. Select the temperature recommended in the table.
- Simmering: This cooking method is suitable for cooking food at low temperatures, thickening sauces, reducing stews and cooking with milk. Select the temperature recommended in the table for the food you want to cook.
- Boiling: This cooking method allows you to boil water with a lid on without it boiling over. This temperature control allows water to be boiled more efficiently. Select the temperature recommended in the table.
- Cooking in a pressure cooker: Follow the manufacturer's recommendations. After the signal tone sounds, continue cooking for the recommended time. Select the temperature recommended in the table.
- Deep fat frying: It is recommended that you heat oil with a lid on. Once the signal tone has sounded, remove the lid and add the food. Select the temperature recommended in the table for the food you want to cook.

Notes

- Always cook with the lid on except when using the "Deep fat frying" function.
- If an audible signal does not sound, make sure there is a lid on the pot. If there is a lid on the pot, the appliance may have reached its maximum power consumption. This may affect the time required to reach the selected temperature. Switch off or reduce the temperature of the cooking positions on which the other pots are placed. See the section entitled → "Wireless Cooking Sensor"
- Never leave oil unattended when it is being heated. Use oil that is suitable for deep fat frying. Do not mix different cooking fats and oils – e.g. oil and lard – as such mixtures may foam up when hot.
- If you are not satisfied with the cooking result, e.g. when boiling potatoes, next time use more water but keep the recommended temperature setting.

Setting the boiling point



The point at which water starts to boil depends on the altitude of your home above sea level. If the water is boiling too vigorously or too weakly, you can set the boiling point. Proceed as follows:

- Touch the  touch button and select the basic setting **CAL** *Cooking sensor calibration*.
- The default setting is set to 650 - 1300 ft (200-400 m). If your home is between 650 - 1300 ft (200-400 m) above sea level, you do not need to set the boiling



point. If it is not, select the setting that best corresponds to the altitude of your home above sea level.

Note: Temperature level 212° F (100 °C) allows for efficient cooking even if the water does not boil very strongly. However, the boiling point can be changed. If you want the water to boil more strongly, for example, you can select the setting for a lower altitude.

Setting procedure

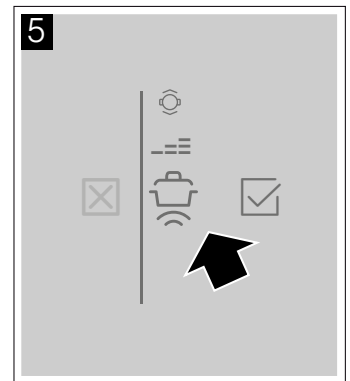
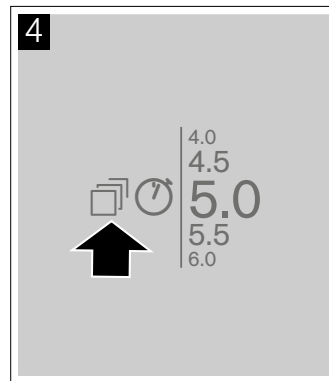
1. Attach the wireless cooking sensor to the cookware; see the section entitled → "Preparing and caring for the wireless cooking sensor"
2. Fill the cookware with a sufficient amount of liquid, put the lid on and place it on the cooking surface. See the section entitled → "Attaching the wireless cooking sensor".
3. Tap the cooking position display for the cookware.
4. Touch the  symbol.
5. Use your finger to scroll up to the  symbol. Then touch the  symbol to confirm your choice.



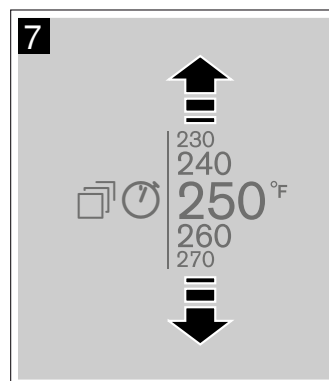

6. Touch the  symbol on the wireless cooking sensor as shown on the display.
7. Select the temperature level.
The mode is activated.
The temperature symbol  next to the cooking position will light up gradually until the selected temperature has been reached. Then a signal will sound and the temperature symbol will switch off.



8. Once the signal tone has sounded, remove the lid and add the food. Leave the lid on while cooking.



Note: The temperature can be increased or decreased by 1 to 10 °F (1 to 5 °C). To do this, touch the selected temperature followed by the  symbol.

Then select the required temperature and touch the  symbol to confirm, or touch the  symbol to cancel and exit the menu.

Table

The following table provides a selection of dishes and is sorted according to foods. Temperature and cooking

Deactivating

1. Touch the temperature level.
2. Touch the  symbol and select a different cookware mode in the settings area.
3. Touch the  symbol to confirm your choice.

Cooking Sensor mode is now deactivated.

time depend on the quantity, condition and quality of the foods.

Meat	Temperature °F (°C)	Time (min)
Simmering		
Sausages ¹	195 (90)	10 - 20
Boiling		
Meatballs ¹	212 (100)	20 - 30
Stewing poultry ¹	212 (100)	60 - 90
Viennese boiled beef ¹	212 (100)	60 - 90
Cooking in a pressure cooker		
Stewing poultry in a pressure cooker ²	240 (115)	15 - 25
Viennese boiled beef in a pressure cooker ²	240 (115)	15 - 25
Deep fat frying		
Deep fat frying chicken portions ³	340 (170)	10 - 15
Deep fat frying meatballs ³	340 (170)	10 - 15

¹ Heat and cook with the lid on. Add the food after the signal sounds.

² Add the food at the start.

³ Heat the oil with the lid on. Fry one portion after the other without the lid.

Fish	Temperature °F (°C)	Time (min)
Simmering		
Stewed fish ¹	195 (90)	15 - 20
Deep fat frying		
Deep fat frying fish in beer batter ²	340 (170)	10 - 15
Deep fat frying breaded fish ²	340 (170)	10 - 15

¹ Heat and cook with the lid on. Add the food after the signal sounds.

² Heat the oil with the lid on. Fry one portion after the other without the lid.

Egg	Temperature °F (°C)	Time (min)
Boiling		
Boiled eggs ¹	212 (100)	5 - 10

¹ Add the food at the start.

Vegetables and legumes	Temperature °F (°C)	Time (min)
Boiling		
Broccoli ¹	212 (100)	10 - 20
Cauliflower ¹	212 (100)	10 - 20
Spinach ¹	212 (100)	5 - 10
Brussels sprouts ¹	212 (100)	30 - 40
Green beans ¹	212 (100)	15 - 30
Chickpeas ²	212 (100)	60 - 90
Peas ¹	212 (100)	15 - 20
Lentils ²	212 (100)	45 - 60

Cooking in a pressure cooker		
Vegetables in a pressure cooker ²	240 (115)	3 - 6
Chickpeas in a pressure cooker ²	240 (115)	25 - 35
Beans in a pressure cooker ²	240 (115)	25 - 35
Lentils in a pressure cooker ²	240 (115)	10 - 20

Deep fat frying		
Deep fat frying breaded vegetables ³	340 (170)	4 - 8
Deep fat frying vegetables in beer batter ³	340 (170)	4 - 8
Deep fat frying breaded mushrooms ³	340 (170)	4 - 8
Deep fat frying mushrooms in beer batter ³	340 (170)	4 - 8

¹ Heat and cook with the lid on. Add the food after the signal sounds.

² Add the food at the start.

³ Heat the oil with the lid on. Fry one portion after the other without the lid.

Potatoes	Temperature °F (°C)	Time (min)
Simmering		
Cooking potato dumplings ¹	185 (85)	30 - 40
Boiling		
Gnocchi ¹	212 (100)	3 - 6
Boiling potatoes ²	212 (100)	30 - 45
Boiling sweet potatoes ²	212 (100)	30 - 45
Cooking in a pressure cooker		
Potatoes in a pressure cooker ²	240 (115)	10 - 20
Sweet potatoes in a pressure cooker ²	240 (115)	10 - 20
Deep fat frying		
Potatoes in a spicy sauce ³	320 (160)	8 - 12

¹ Heat and cook with the lid on. Add the food after the signal sounds.

² Add the food at the start.

³ Heat the oil with the lid on. Fry one portion after the other without the lid.

Pasta and cereals	Temperature °F (°C)	Time (min)
Poaching		
Semolina pudding ³	185 (85)	5 - 10
Parboiled rice ¹	195 (90)	25 - 35

¹ Heat and cook with the lid on. Add the food after the signal sounds.

² Add the food at the start.

³ Stir frequently.

Pasta and cereals	Temperature °F (°C)	Time (min)
Brown rice ²	195 (90)	45 - 55
Exotic rice (e.g. basmati, Thai) ²	195 (90)	8 - 12
Wild rice ²	195 (90)	20 - 30
Quinoa ¹	195 (90)	10 - 12
Polenta ³	185 (85)	3 - 8

Boiling		
Durum wheat pasta ³	212 (100)	7 - 10
Fresh pasta ³	212 (100)	3 - 5
Whole grain pasta ³	212 (100)	7 - 10
Durum wheat pasta, stuffed ³	212 (100)	15 - 20
Fresh pasta, stuffed ³	212 (100)	5 - 8

Cooking in a pressure cooker		
Rice in a pressure cooker ²	240 (115)	6 - 8
Brown rice in a pressure cooker ²	240 (115)	12 - 18

¹ Heat and cook with the lid on. Add the food after the signal sounds.

² Add the food at the start.

³ Stir frequently.

Soups	Temperature °F (°C)	Time (min)
--------------	----------------------------	-------------------

Simmering		
Instant cream soups ²	195 (90)	10 - 15

Boiling		
Home-made broths ¹	212 (100)	60 - 90
Instant soups ²	212 (100)	5 - 10

Cooking in a pressure cooker		
Home-made broths in a pressure cooker ¹	240 (115)	20 - 30

¹ Add the food at the start.

² Stir frequently.

Dessert	Temperature °F (°C)	Time (min)
----------------	----------------------------	-------------------

Simmering		
Rice pudding ³	185 (85)	40 - 50
Porridge ³	185 (85)	10 - 15
Chocolate pudding ³	185 (85)	3 - 5

Boiling		
Compote ¹	212 (100)	15 - 25

Deep fat frying		
Deep fat frying jam-filled doughnuts ²	320 (160)	5 - 10
Deep fat frying ring doughnuts ²	320 (160)	5 - 10
Deep fat frying buñuelos ²	320 (160)	5 - 10

¹ Add the food at the start.

² Heat the oil with the lid on. Fry one portion after the other without the lid.

³ Stir frequently.

Frozen products	Temperature °F (°C)	Time (min)
Keeping warm, heating Vegetables in cream sauce ⁴	155 (70)	15 - 20
Boiling Green beans, frozen ¹	212 (100)	15 - 30
Deep fat frying Deep fat frying French fries ³	350 (180)	4 - 8

¹ Heat and cook with the lid on. Add the food after the signal sounds.

² Add the food at the start.

³ Heat the oil with the lid on. Fry one portion after the other without the lid.

⁴ Stir frequently.

Miscellaneous	Temperature °F (°C)	Time (min)
Keeping warm, heating Heating goulash soup ¹ Heating mulled wine ¹	155 (70) 155 (70)	10 - 20 5 - 15
Simmering Heating milk ¹	185 (85)	3 - 10

¹ Add the food at the start.

MyZone™

With this function, the default power levels are displayed when cookware is placed on the cooking surface.

This allows you to change the power level during cooking simply by moving the cookware forward or backward.

Default power levels: **1.0, 3.0, 5.0, 7.0** and **9.0**.

To change the default power levels, see the section entitled → *"Basic Settings"*.



Notes

- If this function is not available in the settings area, the cookware may be too big. Use a smaller item of cookware.
- If the function does not activate when you select the heat setting, the appliance may have reached its maximum power consumption.
- For more information on the size and positioning of the cookware, see the section entitled → *"Cooking with Induction"*.

Activation

Place the cookware on the cooking surface.

1. Tap the cooking position display for the cookware.
2. Touch the  symbol.

3. Use your finger to scroll down to the  symbol. Then touch the  symbol to confirm your choice.

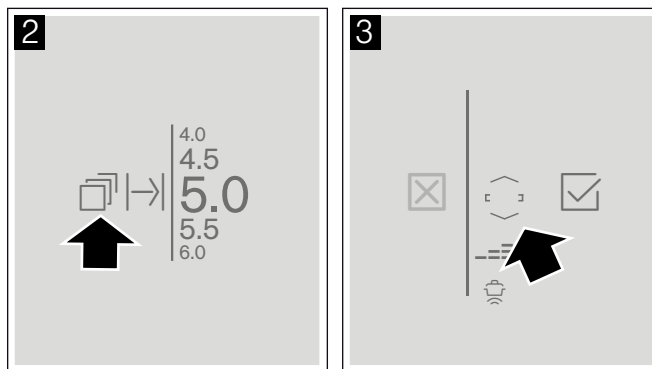

The function has now been activated.

4. Move the cookware over the cooking surface until the power level you require is set. The power level you have selected will appear on the cooking position display.

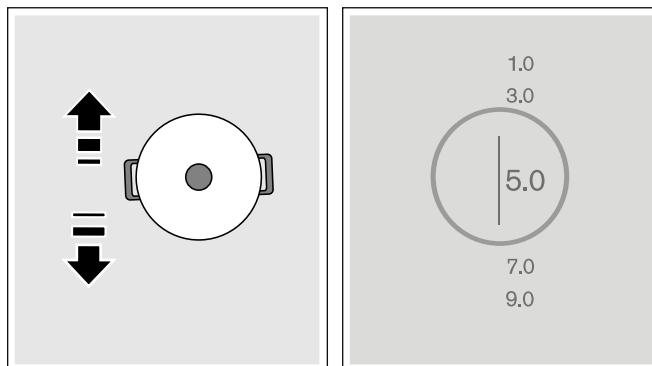



Changing the power level

You can change the power levels while you are cooking. To choose a different power level in the programming area, touch the area you want to change the power level of.

Note: If the function is deactivated, the power level will return to the default values.

Deactivating

1. Touch the power level.
2. Touch the  symbol and select a different cookware mode in the settings area.
3. Touch the  symbol to confirm your choice. The function has now been deactivated. The heat setting you selected previously will be retained.

TeppanyakiPro™ Mode

This mode enables you to divide the teppanyaki grilling area into two sections: A hot section with assigned grill setting and a section to which no grill setting has been assigned.

You can change the power levels during cooking.

Note: If this mode is not available in the settings area, the cookware may be too big. Use a smaller item of cookware.

Suitable cookware







There are teppanyaki griddle plates that are optimally suited to this mode. These accessories can be purchased from specialist retailers, Customer Support or THERMADOR® eShop. Order the relevant reference number:

- TEPPAN1321
Griddle style teppanyaki 13" x 21" (325 x 530 mm)
- TEPPAN1016
Griddle style teppanyaki 10" x 16" (255 x 400 mm)

Activation

Place the cookware on the cooking surface horizontally or vertically.

1. Touch the cooking position display.
2. Touch the  symbol.
3. Scroll upwards with your finger until you reach the symbol for the teppanyaki griddle on the cooking surface.

Symbol	Position
	Vertical position, two areas warm
	Vertical position, bottom area warm
	Vertical position, top area warm
	Horizontal position, two areas warm
	Horizontal position, right area warm
	Horizontal position, left area warm

Note: Only the available symbols for the size of the teppanyaki griddle and its position on the cooking surface are displayed.

Touch the  symbol to confirm your choice.

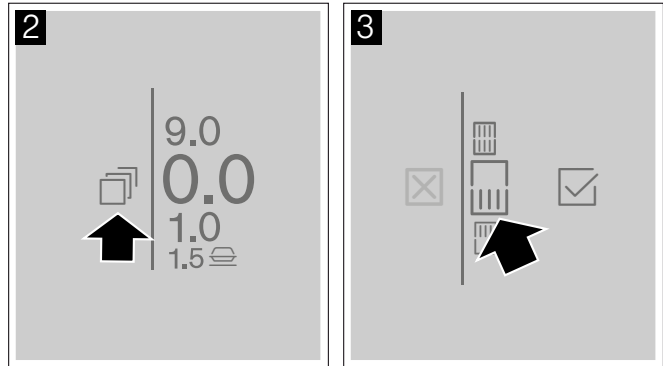

4. Select the power level you require from the settings area.

The display shows the position of the teppanyaki griddle with the selected power level for a section or for the entire area the cookware is touching. The  symbol for residual heat will appear by the section to which no power level has been assigned.





The mode is active.

Changing the power level

Touch the assigned area of the power level and use your finger to scroll up or down to the power level you require.

Note: If the orientation of the Teppanyaki is changed, select the appropriate option for the new position on the cooking surface.

Deactivating

1. Touch the power level.
2. Touch the  symbol and select a different cookware mode in the settings area.
3. Touch the  symbol to confirm your choice. The mode is deactivated.

Panel Lock

The Panel Lock function enables you to lock the cooktop to prevent it from being switched on accidentally.

Note: If one of the cooking positions is switched on, you will not be able to activate the Panel Lock function.

Activation

The cooktop must be switched on.

Touch and hold the  symbol for approx. 4 seconds.

The  symbol will light up.

The Panel Lock is now activated. The cooktop is locked.

Deactivating

The cooktop must be switched on.

Touch and hold the  symbol for approx. 4 seconds.

The  symbol will light up.

The Panel Lock is now deactivated. The cooktop is unlocked.

Automatic Panel Lock

This function automatically activates the Panel Lock whenever the cooktop is switched off.

Activating and deactivating

You can find out how to activate the automatic Panel Lock in the section entitled  *"Basic Settings"*

Note: To deactivate the automatic Panel Lock, touch and hold the  symbol for approx. 4 seconds.

Pause function

When the Pause function is activated, the settings you have selected appear in the display. No power level is used and the cooking times you have set are stopped. If the Kitchen Timer or Stopwatch Timer has been activated, it will continue running. If the Pause function has been activated, the timer duration cannot be changed.

The Pause function has no effect on the main switch. You can switch the cooktop off at any time.



Activation

Touch the  symbol to pause. The cooktop will be locked for 30 minutes. You can now clean the surface of the touchscreen display, for example, without altering the settings.

Note: The  symbol will only be displayed in the function bar, if cooking has been started.

Deactivating

The cooktop will switch off automatically after 30 minutes.

To switch the function off and resume cooking before 30 minutes have elapsed, touch the  symbol and then the  symbol to confirm.

Note: If you move the cookware across the cooking surface while the function is activated, the settings may all be lost.

Automatic Shutoff

If a cooking position is in operation for a long time and none of the settings are changed, the automatic safety switch-off function is activated.







This stops the cooking position from heating up. A message will appear on the display.







Touch the  symbol. The cooking position settings can now be reconfigured.

The point at which the automatic safety switch-off function is activated depends on the power level that has been set (after 1 to 10 hours).

Basic Settings

The appliance has various basic settings. You can adapt these settings to your personal requirements.

Settings	Description and options
 Brightness	You can change the brightness of the touchscreen display.
 Start screen	You can choose whether or not you want the brand logo to be displayed when you switch on the cooktop.
 Sounds	You can configure the type, volume and length of the signal tones you want the appliance to sound.
 MyZone™ - power levels	You can change the default power levels of the cooking areas for the mode "My Zone - Dynamic cooking for one item of cookware".
CAL  Cooking sensor calibration	Set your height above sea level to adjust the boiling point.
 Cooking sensor pairing	Connect the wireless cooking sensor to the cooktop.
 Temperature format	You can change the temperature format.

	Language	You can change the language used in the display.
	Appliance index and production date	You can view information about your appliance.
	Automatic restore	You can set how long the appliance saves the most recently used settings after it has been switched off.
	Presettings	You can restore all settings to the factory settings.
	Panel Lock	You can use the Panel Lock to lock the cooktop and prevent children from using it without supervision.
	Cooktop - Hood Sync	The extractor hood can be controlled from the cooktop either by connecting the two appliances in the home network or by connecting the extractor hood directly to the cooktop.
	Home Connect	This enables you to connect the appliance to your home network and a mobile end device.

To go to the basic settings

All cooking positions must be deactivated.

1. Touch the  symbol. The basic settings menu will appear on the display.
2. The default setting is brightness. Use your finger to scroll to the left or right and select a different setting.

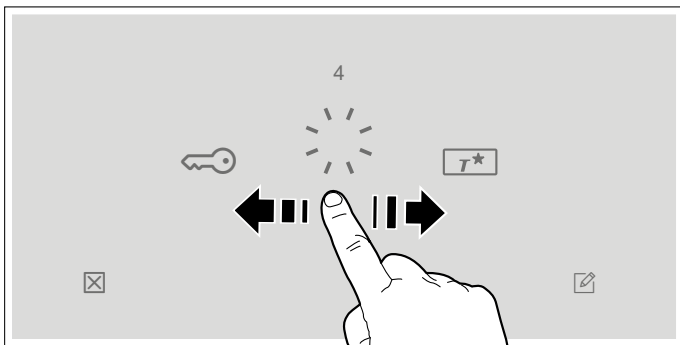

3. To change the selected setting, touch the  symbol.

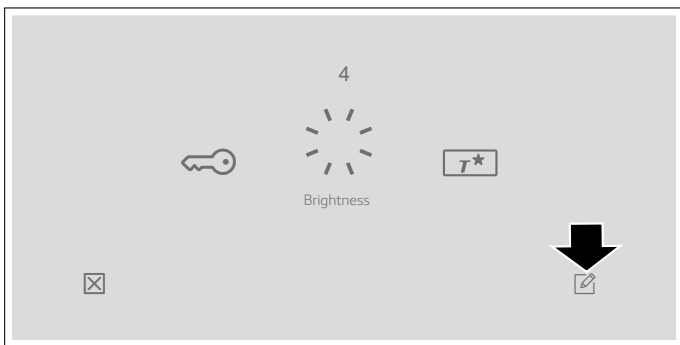

4. Change the selected setting.

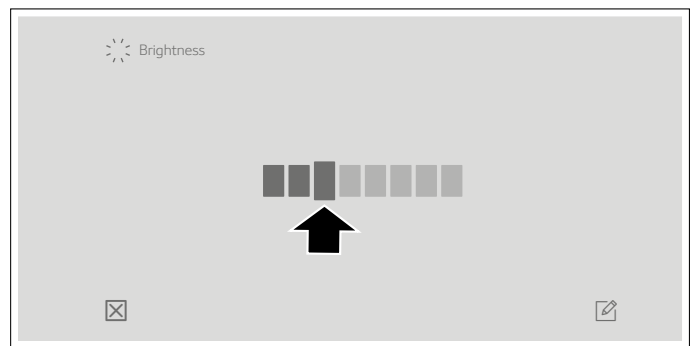

5. Touch the symbol to confirm your choice. The settings are saved.
To cancel and exit the menu, touch the symbol.

Exiting the basic settings menu

To exit the basic settings, touch the symbol.

Home Connect

This appliance is Wi-Fi enabled and settings can be sent to the appliance via a mobile device.

If the appliance is not connected to the home network, the appliance functions in the same way as a cooktop with no network connection. The cooktop can always be operated via the control panel.

The availability of the Home Connect function depends on the availability of Home Connect services in your country. Home Connect services are not available in every country. You can find more information on this at www.home-connect.com.

Notes

- Cooktops are not designed to be used unattended – you must always keep an eye on the cooking process.
- Ensure that you follow the safety instructions in this instruction manual and that these are also observed when operating the appliance via the Home Connect app. Follow the instructions in the Home Connect app.
- Using the Home Connect app, you can send settings to your appliance, and you must then confirm these on the appliance. It is not possible to operate the appliance while you are away from home.
- If the appliance is being operated by the controls on the appliance itself, this mode of operation always has priority. It is not possible to operate the appliance using the Home Connect app during this time.

Connection to your home network

To implement settings via Home Connect, you must have installed and set up the Home Connect app on your mobile device.

Refer to the Home Connect documents supplied for more information.

The appliances must be connected to the same home network.

Setting up the Home Connect app



Note: You require a mobile device with the latest version of the relevant operating system.

1. On your mobile device, go to the App Store (Apple devices) or to the Google Play Store (Android devices).
2. Enter "Home Connect" in the search field.
3. Select the Home Connect app and install it on your mobile device.
4. Start the app and create your Home Connect login details. The app will guide you through the registration process. Make a note of your e-mail address and password.

Automatic Registration in the Home Network

You require a router that has WPS functionality.

Access to the router is required. If you do not have this, follow the steps under "Manually logging into your home network".

1. To open the basic settings, touch the  symbol on the main screen.
2. Scroll left or right with your finger and select the  Home Connect setting.

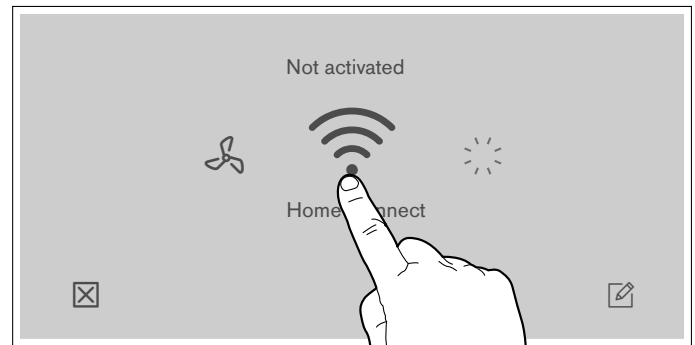

3. The conditions needed to establish a Home Connect connection will be displayed. Touch the symbol to confirm.
4. Select the *Automatic* option and touch the symbol to confirm your choice.
5. Press the WPS button on your router within 2 minutes, as shown on the display.

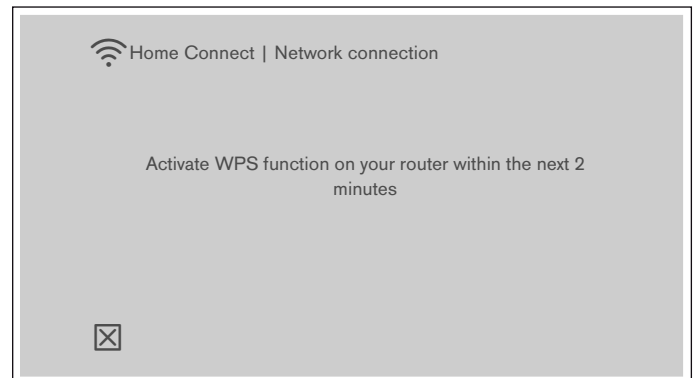

6. A message will be displayed to notify you when the cooktop is successfully connected to your home network. Confirm by touching the symbol.

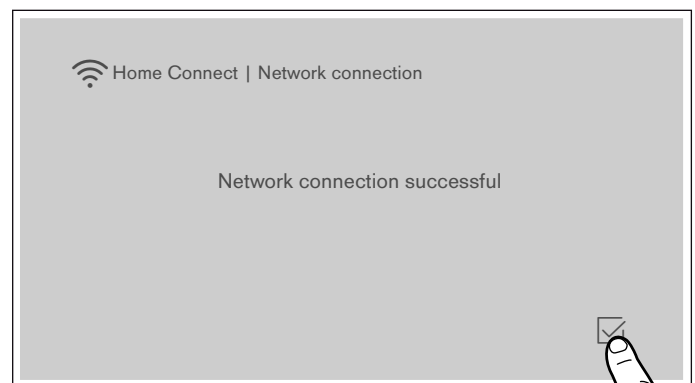

7. Now open the Home Connect app on your mobile device and follow the connection instructions on the display.

- A message will be displayed to confirm that connection to the app has been successful. Touch the symbol to confirm.

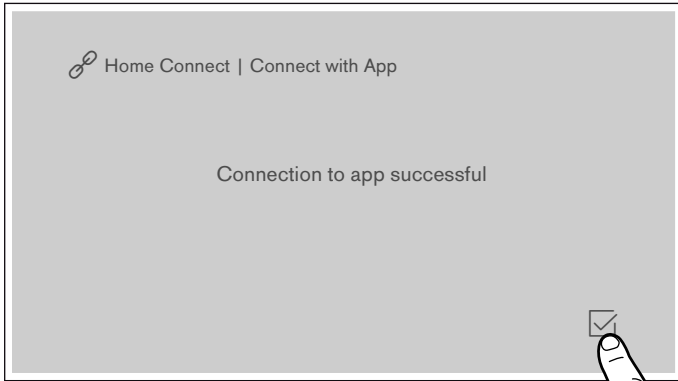

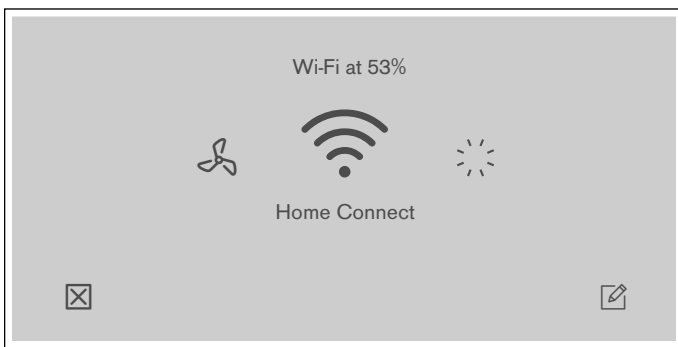

The basic settings menu will reappear on the display, together with the connection type and the strength of the connection to your home network. Touch the symbol to return to the main screen or select the *Home Connect* setting to go to the Home Connect settings.



The  symbol will appear on the main screen.

Note: If the appliance is unable to connect, relaunch the assistant or manually log the appliance into your home network.

Manual Registration in the Home Network

- To open the basic settings, touch the  symbol on the main screen.
- Scroll left or right with your finger and select the  *Home Connect* setting.

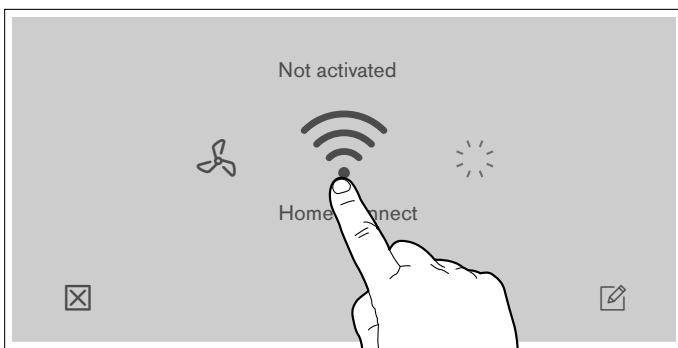

- The conditions needed to establish a Home Connect connection will be displayed. Touch the symbol to confirm.
- Select the *Manual* option and confirm by touching the symbol.

- A message will appear on the display for opening the network settings of the mobile device. Touch the symbol to confirm.
- You now have 5 minutes to register the mobile device with the SSID "HomeConnect" and the password "HomeConnect".

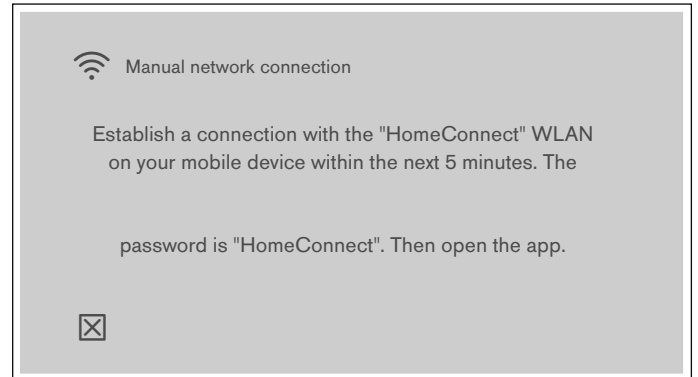

- Then open the Home Connect app on your mobile device.

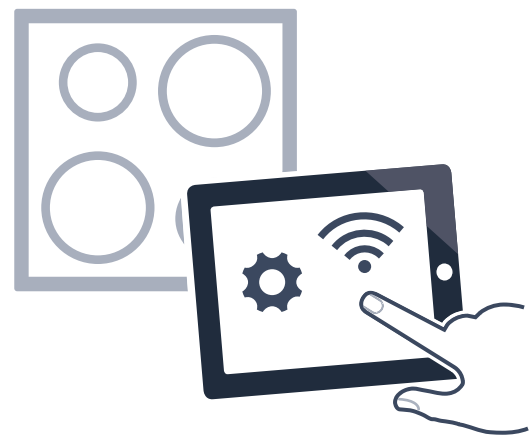

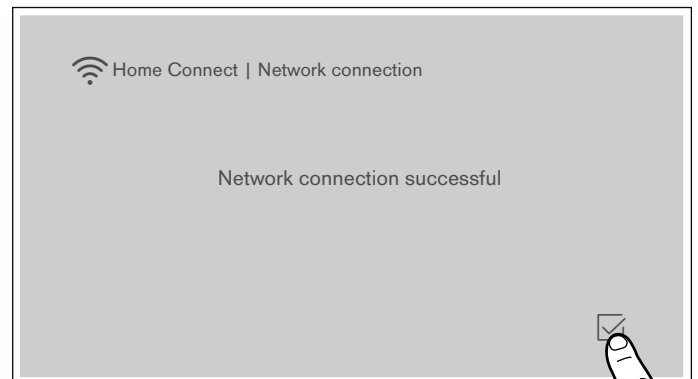

- A message will be displayed to notify you when the cooktop is successfully connected to your home network. Confirm by touching the symbol.



- Now open the Home Connect app on your mobile device and follow the connection instructions on the display.

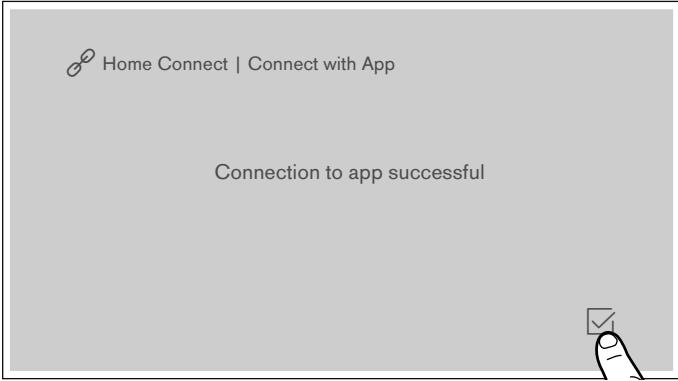



10. A message will be displayed to confirm that connection to the app has been successful. Touch the  symbol to confirm.



The basic settings menu will reappear on the display, together with the connection type and the strength of the connection to your home network. Touch the  symbol

Home Connect Settings





You can adjust Home Connect to suit your requirements at any time.

Settings	Description
 Connection	Set the Wi-Fi connectivity to On or Off.
 Connect with the app	The connection can be made using one or more Home Connect accounts.
 Settings via app	You can choose whether to allow cooking settings to be sent.
 Delete network settings	Delete all network settings from appliance

Note: These settings are only displayed if the appliance is already connected to your home network.

Wi-Fi symbols

The Wi-Fi indicator on the main control panel changes depending on the status of the connection and the availability of the Home Connect server.

Symbol	Description
	Home network available
	No connection to Home Connect server
	No Wi-Fi connection available
	Ongoing maintenance

to return to the main screen or select the *Home Connect* setting to go to the Home Connect settings.

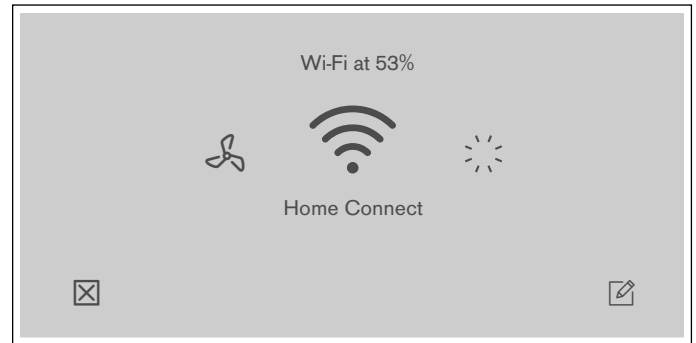

The  symbol will appear on the main screen.

Note: If the appliance is unable to connect, relaunch the assistant or manually log the appliance into your home network.

In the basic settings for your cooktop, navigate to the Home Connect settings to display network and appliance information.

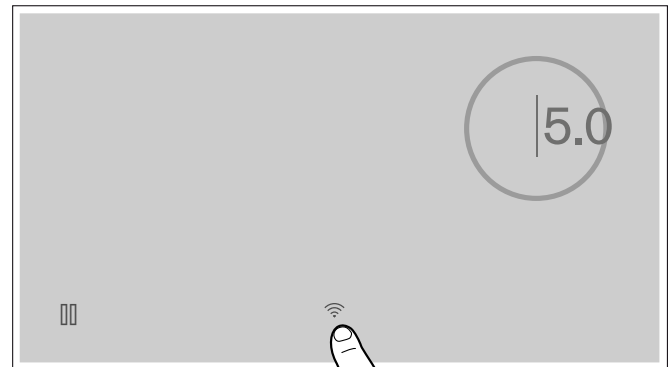



Deactivate Wi-Fi

The Home Connect function can be used as long as Wi-Fi has been activated.

Note: In networked standby mode, the appliance requires a maximum of 2 W.

To deactivate Wi-Fi, proceed as follows:

1. To open the basic settings, touch the  symbol on the main screen.
2. Scroll left or right with your finger and select the  *Home Connect* setting.

3. Select the **Connection** option.

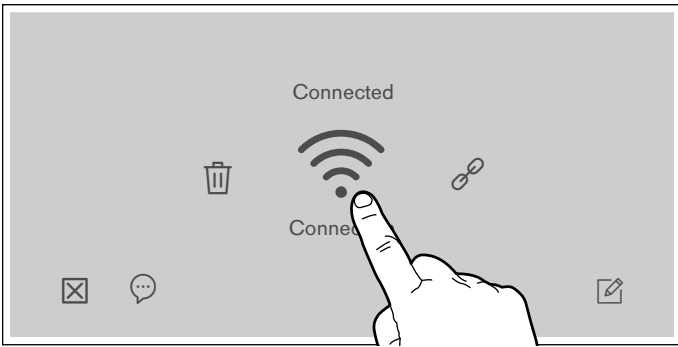



4. Select the **Off** option.

This deactivates Wi-Fi; the  symbol on the control panel will go out.

Disconnecting from your home network

You can disconnect the cooktop from the network at any time.

Note: If the cooktop is disconnected from the network, it is not possible to operate it using Home Connect.

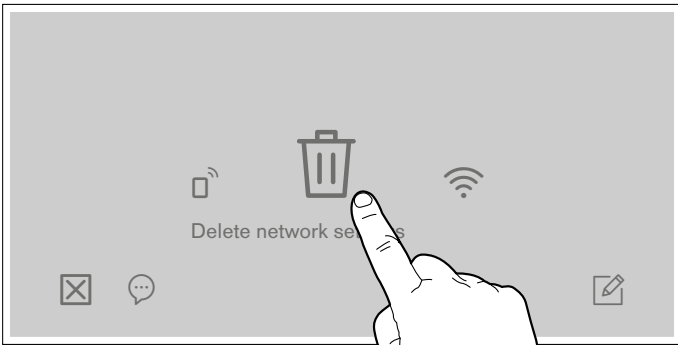

1. To open the basic settings, touch the  symbol on the main screen.
2. Scroll left or right with your finger and select the  *Home Connect* setting.
3. Select *Delete network settings*.



This disconnects the appliance from your home network; the  symbol on the control panel will go out.

Note: The network connection will also be deleted if you restore the factory settings on your appliance.

Connecting to your home network



1. To open the basic settings, touch the  symbol on the main screen.
2. Scroll left or right with your finger and select the  *Home Connect* setting.
3. Select **Connection**.
4. Follow the instructions in the section entitled "Manually logging into your home network" or "Automatic login to your home network".

Connect to App

If the Home Connect app is installed on your mobile device, you can connect it to the cooktop.

You can connect more than one mobile device to the cooktop.

Notes

- The appliance must be connected to your home network.
 - The Home Connect app must be opened and configured on your mobile device.
 - If your hood is directly connected, first disconnect the cooktop from your home network and then repeat the connection process.
1. To open the basic settings, touch the  symbol on the main screen.
 2. Scroll left or right with your finger and select the  *Home Connect* setting.
 3. Touch *Connect with app*.

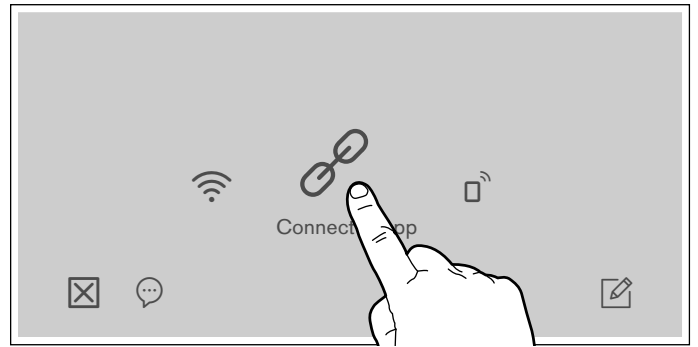



Another Home Connect account can also be connected to the cooktop. To do this, touch *Connect to app* again.

4. Follow the instructions in the app to complete the connection process.

Settings via app

Using the Home Connect app, you can easily access the basic settings for your cooktop and send settings for the cooking positions to the cooktop.

Notes

- If the appliance is being operated by means of the controls on the appliance itself, this mode of operation always has priority. When the controls on the appliance itself are being used, you will not be able to operate it via the Home Connect app.
 - The transfer settings option is activated by default.
 - If the settings transfer option has been deactivated, only the cooktop's operating statuses will be displayed in the Home Connect app.
1. To open the basic settings, touch the  symbol on the main screen.
 2. Scroll left or right with your finger and select the  *Home Connect* setting.

3. Touch **Settings via app.**

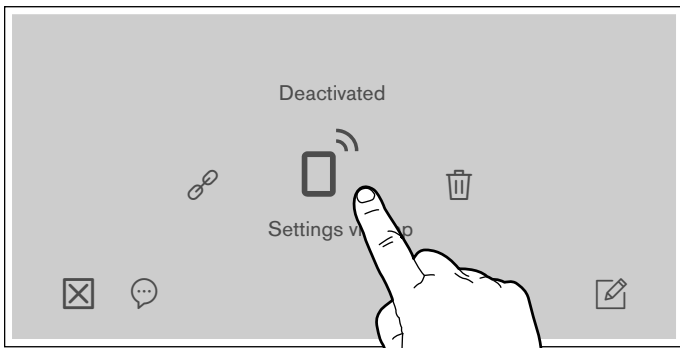

4. To activate the settings transfer option, touch **Yes**; to deactivate the settings transfer option, touch **No**.

Confirming settings

Once the settings have been transferred to a cooking zone, a confirmation message will appear on the cooktop's touchscreen display.

Software Update

Using the software update function, the cooktop's software can be updated (e.g. for the purpose of optimization, troubleshooting or security updates). To use the app, you must first register as a Home Connect user, install the app on your mobile device and connect to the Home Connect server.

The Home Connect app will tell you when a software update is available. You can start the software update via the app or the cooktop. To do this, refer to the instructions on the display.

Once the update has been successfully downloaded, you can install it via the Home Connect app if you are connected to your local area network.

The Home Connect app will notify you when the update has been successfully installed.

Notes

- You can continue to use the cooktop as normal while updates are downloading.
- Depending on your personal settings in the app, software updates can also be set to download automatically.
- We recommend that you install security updates as soon as possible.

Information on Data Protection

When your appliance is connected to a WLAN network that is connected to the Internet for the first time, your appliance transmits the following categories of data to the Home Connect server (initial registration):

- Unique appliance identification (consisting of appliance codes as well as the MAC address of the installed Wi-Fi communication module).
- Security certificate of the Wi-Fi communication module (to ensure a secure data connection).
- The current software and hardware version of your appliance.
- Status of any previous resetting to factory settings.

This initial registration prepares the Home Connect functions for use and is only required when you want to use these Home Connect functions for the first time.

Note: Ensure that the Home Connect functions can be used only in conjunction with the Home Connect app. Information on data protection can be accessed in the Home Connect app.

Wi-Fi® Module

FCC/IC Statements

Model: COM2

FCC ID: 2AHES-COM2

IC ID: 21152-COM2

The Home Connect module is a communication device designed to provide communication between appliances and smart devices.

This module is integrated at the factory, under direct control of BSH Home Appliances Corporation, and is not user serviceable or upgradable. At least 7⁷/₈ inch (20 cm) separation distance should be maintained from device to user.

FCC COMPLIANCE STATEMENT

▲ CAUTION

Changes or modifications not expressly approved could void your authority to use this equipment.

This device complies with Part 15 of the FCC Rules. Operation to the following two conditions:

1. This device may not cause harmful interference, and
2. This device must accept any interference received, including interference that may cause undesired operation.

INDUSTRY CANADA STATEMENT

This device complies with Industry Canada license-exempt RSS standard(s).

Operation is subject to the following two conditions:

1. This device may not cause interference, and
2. This device must accept any interference, including interference that may cause undesired operation of the device.

Cooktop - Hood Sync

You can connect this appliance to a matching hood and then control the functions of the hood via your cooktop. There are various options for connecting the appliances:

Home Connect

Two appliances can be connected using the Home Connect app provided, that both of them are Home Connect-compatible.

Refer to the Home Connect documents supplied for more information.



Connecting appliances directly

If the appliance is connected directly to a hood, it cannot be connected to your home network as well. The appliance functions in the same way as a cooktop with no network connection. The cooktop can always be operated via the control panel.

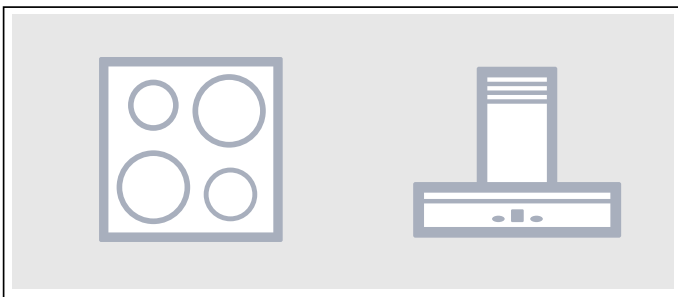

Connecting appliances via your home network

If the appliances are connected to each other via your home network, both the hood controls and Home Connect can be used to operate the cooktop.

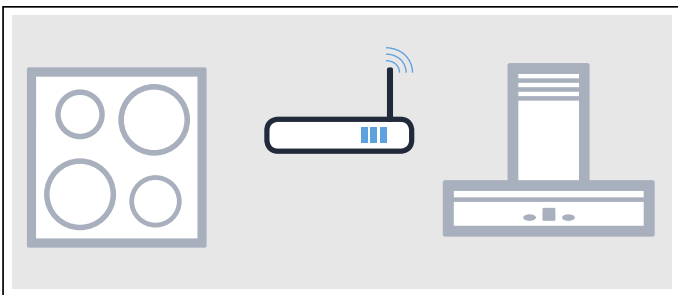

Notes

- Make sure you follow the safety instructions in the instruction manual for your hood and that these are complied with even when operating the appliance via the hood controls on the cooktop.
- If the appliance is being operated by means of the controls on the hood, this mode of operation always has priority. It is not possible to use the hood controls on the cooktop during this time.
- In networked standby mode, your appliance requires a maximum of 2 W.

Setting up a connection



To set up the connection between the cooktop and the hood, the cooktop must be switched on.

Connecting directly

Make sure that the hood is switched off.

For more information, refer to the section entitled "Connecting to the cooktop" in the instruction manual for your hood.

Note: If you connect your cooktop directly to the hood, it cannot be connected to your home network as well and you will not be able to use Home Connect.

1. To open the basic settings, touch the  symbol on the main screen.
2. Use your finger to scroll to the left or right and select the  *Cooktop - Hood Sync* setting.
3. Select the "Cooktop - Hood Sync" option and touch the symbol to confirm.
4. You have 2 minutes to initiate the connection process on the hood. See hood operating instructions.

Once the process is complete, a message will appear indicating whether or not connection has been successful. If connection has been successful, the  symbol for controlling the hood from the cooktop will appear on the main screen.



If you want to change the setting, select the  *Cooktop - Hood Sync* option and then make the necessary change.

Connecting via your home network

You require a router that has WPS functionality.

Access to your router is required. If you do not have this, follow the steps listed under "Direct connection".

When you begin, make sure that the hood is connected to the same home network.

1. To open the basic settings, touch the  symbol on the main screen.
2. Use your finger to scroll to the left or right and select the  *Cooktop - Hood Sync* setting.
3. Select the *Home Connect* option and touch the symbol to confirm.

4. Press the WPS button on the router within the next 2 minutes.

A message will be displayed to notify you when the cooktop is successfully connected to your home network.



5. You have 2 minutes to initiate the connection process on the hood. See hood operating instructions.

Once the process is complete, a message will appear indicating whether or not connection has been successful. If connection has been successful, the  symbol for controlling the hood from the cooktop will appear on the main screen.

Note: Connection can only be established when both appliances are connected to your home network and the connection process has been initiated for both of them. If the time allowed for connecting has already expired for one of the two appliances, initiate the connection process again.

Disconnecting from the network

The connection to your home network can be deleted.

1. To open the basic settings, touch the  symbol on the main screen.
2. Use your finger to scroll to the left or right and select the  *Cooktop - Hood Sync* setting.
3. Select *Disconnect from network* and touch the symbol to confirm.

The connections have now been deleted.

Note: The connection to the home network can be re-established at any time.



Controlling the hood via the cooktop

In the cooktop's basic settings, you can configure what the hood should do when the cooktop or individual cooking positions are switched on or off.

You can select other settings using the control panel.



Setting the fan

Activation

1. Touch the  symbol on the main screen.
2. Select the  *Cooktop - Hood Sync* option.
3. Select the fan level in the settings area. The following settings are possible:

0	Fan off
1, 2,	Fan levels.
3, 4	Intensity: low, medium, high
	Intensive setting

The following may also be displayed depending which hood model you have installed:

A	Automatic mode
	Delay shut off mode
	Interval mode
>>>	Boost mode



The selected level will appear on the main screen next to the  symbol.

Deactivating

Select fan setting 0.

Setting Automatic Mode

Activation

1. Touch the  symbol on the main screen.
2. Select the  *Cooktop - Hood Sync* option.
3. Select **A** for "Automatic mode".



Depending on how the hood sensor is configured, the fan will start automatically when it detects smoke. For additional information, see hood operating instructions.

Deactivating

1. Touch the  symbol on the main screen.
2. Select a different fan setting.

Setting the hood lighting

You can switch the hood light on and off via the cooktop's control panel.





1. Touch the  symbol on the main screen.
2. Select the option  *Light Control*.
3. Set light intensity and touch the symbol to confirm.

Depending on the basic settings you have selected, the light will automatically be switched on or off when the cooktop is switched on or off. → "*Basic Settings*"

Hood control settings

You can adjust the cooktop-based hood controls to suit your requirements at any time.

Note: The settings will only be displayed if the appliance is connected to a hood.

Settings	Description
 Automatic mode	You can select the fan level for the hood to start when the cooktop is switched on.
 Delay shut off function	The delay shut off function keeps the fan running for a certain amount of time after the cooktop has been switched off.
 Brightness	You can select the brightness level with which the lamp in the hood lights up when the cooktop is switched on.
 Automatic light off	You can select whether you want the lamp in the hood to be switched off when the cooktop is switched off.
 Disconnecting Cooktop - Hood Sync	The direct connection between the hood and the cooktop can be broken.

Some of these settings may not be available

Cleaning and Maintenance

Daily Cleaning

Note: Recommended cleaners indicate a type of cleaner and do not constitute an endorsement of a specific brand.

Glass ceramic cooktop

▲ CAUTION

Do not use any kind of cleaner on the glass while the surface is hot; use only the razor blade scraper. The resulting fumes can be hazardous to your health. Heating the cleaner can chemically attack and damage the surface.

Clean the surface when it is completely cool, with the following exception: remove dry sugar, sugar syrup, tomato products and milk immediately with the razor blade scraper (see cleaning chart).

Wipe off spatters with a clean, damp sponge or a paper towel. Rinse and dry. Use white vinegar if smudge remains; rinse.

Apply a small amount of the glass ceramic cooktop cleaner. When dry, buff surface with a clean paper towel or cloth.

Cleaning guidelines

When using a cleaner, use only a small amount; apply to a clean paper towel or cloth. Wipe on the surface and buff with a clean dry towel.

For best results, use cleaners such as glass ceramic cooktop cleaner, BonAmi®, Soft Scrub® (without bleach), and white vinegar.

Avoid these cleaners

- Glass cleaners which contain ammonia or chlorine bleach. These ingredients may damage or permanently stain the cooktop.
- Caustic cleaners - cleaners such as Easy Off® may stain the cooktop surface.
- Abrasive cleaners.
- Metal scouring pads and scrub sponges such as Scotch Brite® can scratch and/or leave metal marks.
- Soap-filled scouring pads such as SOS® can scratch the surface.
- Powdery cleaners containing chlorine bleach can permanently stain the cooktop.
- Flammable cleaners such as lighter fluid or WD-40.

Cleaning chart

Type of Soil	Possible Solution
Dry sugar, sugar syrup, milk or tomato spills. Melted plastic film or foil. All these items REQUIRE IMMEDIATE REMOVAL. Failure to remove these immediately can permanently damage the surface.	Remove these types of spills while the surface is hot using the razor blade scraper. Use a new, sharp razor in the scraper. Remove pan and turn off the element. Wearing an oven mitt, hold scraper at 30° angle, using care not to gouge or scratch the glass. Push soil off the heated area. After the surface has cooled, remove the residue and apply the glass ceramic cooktop cleaner. ▲ WARNING RISK OF INJURY The blade is extremely sharp. Risk of cuts. Protect the blade when not in use. Replace the blade immediately when any imperfections are found. Follow manufacturer's instructions.
Burned-on food soil, dark streaks, and specks	Soften by laying a damp paper towel or sponge on top of soil for 30 minutes. Use a plastic scrubber and glass ceramic cooktop cleaner or use the razor blade scraper. Rinse and dry.
Greasy spatters	Use a soapy sponge or cloth to remove grease; rinse thoroughly and dry. Apply glass ceramic cooktop cleaner.
Metal marks: Iridescent stain	Pans with aluminum, copper or stainless steel bases may leave marks. Treat immediately after surface has cooled with glass ceramic cooktop cleaner. If this does not remove the marks, try a mild abrasive (Bon Ami®, Soft Scrub® without bleach) with a damp paper towel. Rinse and reapply glass ceramic cooktop cleaner. Failure to remove metal marks before the next heating makes removal very difficult.
Hard water spots: Hot cooking liquids dripped on surface	Minerals in some water can be transferred onto the surface and cause stains. Use undiluted white vinegar, rinse and dry. Recondition with glass ceramic cooktop cleaner. Remove boilovers and stains before using the cooktop again.
Surface scratches: Small scratches are common and do not affect cooking. They become smoother and less noticeable with daily use of the glass ceramic cooktop cleaner.	Apply glass ceramic cooktop cleaner before using to remove sand-like grains and grit such as salt and seasoning. Scratches can be reduced by using pans with bases that are smooth, clean, and dry before use. Use recommended glass ceramic cooktop cleaner daily. NOTICE: Diamond rings may scratch the surface.

Maintenance

This appliance requires no maintenance other than daily cleaning. For best results, apply cooktop cleaning cream daily.

Frequently-asked questions and answers (FAQ)

Use

Nothing appears on the display

The brightness may not be set correctly. Look at the display from above and set the brightness in the basic settings.

For more information about the settings, see the section entitled → *"Basic Settings"*

The main display shows a warning message and a signal tone sounds

Remove any liquid or remnants of food from the control panel. Remove any objects from the control panel.

For instructions on how to deactivate the signal tone, see the section entitled → *"Basic Settings"*

Noises

Why can I hear noises while I'm cooking?

Noises may be generated while using the cooktop depending on the properties of the base of the cookware. These noises are normal for induction technology. They do not indicate that there is a fault.

Possible noises:

A low humming noise of the kind a transformer makes:

Occurs when cooking at a high heat setting. The noise disappears or becomes quieter when the heat setting is reduced.

Quiet humming:

The cookware may be too small for the cooking position or not suitable for induction cooking. Use larger cookware or move it to a different position on the cooking surface.

Quiet whistling:

This occurs when the cookware is empty. The noise disappears when water or food is added to the cookware.

High-pitched whistling noises:

These may occur if two cooking positions are used at the highest heat setting at the same time. The whistling noises disappear or become quieter when the heat setting is reduced.

Crackling:

This occurs when using cookware made from layers of different material or when using cookware of different sizes and different materials at the same time. How loud the noise is may vary depending on the quantity of food you are cooking and the method you are using.

Fan noise:

The cooktop is equipped with a fan that switches on automatically at high temperatures. The fan may continue to run even after you have switched off the cooktop if the temperature detected is still too high.

Clicking:

Occasional clicking when activating or moving an item of cookware is completely normal.

Now and again, other completely random noises that have nothing to do with the cookware may occur.

Cookware

Which types of cookware can be used with an induction cooktop?

For information on which types of cookware can be used with an induction cooktop, see the section entitled → *"Cooking with Induction"*

Why is the cooktop not heating?

Make sure the cookware is suitable for use with an induction cooktop. For information on the type, size and positioning of the cookware, see the section entitled → *"Cooking with Induction"*

Why is it taking so long for the cookware to heat up or why is it not heating up correctly despite being on a high heat setting?

Make sure the cookware is suitable for use with an induction cooktop. For information on the type, size and positioning of the cookware, see the section entitled → *"Cooking with Induction"*

The depiction of the cookware on the touchscreen display does not match the actual cookware in terms of size and shape

The depiction of the cookware on the touchscreen display is purely indicative.

Make sure that the cookware is completely inside the usable area of the cooking surface.

There is cookware on the cooking surface that is not being shown on the touchscreen display.

There are more than eight items of cookware on the cooking surface.

The cookware is too small: A diameter of between 3½ and 13" (90 and 340 mm) is recommended.

Use a larger cookware or cookware that is suitable for induction cooking. Alternatively, switch the positions of the cookware on the cooking surface. For information on which types of cookware can be used with an induction cooktop, see the section entitled → *"Cooking with Induction"*

There are two items of cookware on the cooking surface. However, the touchscreen display displays this as just one item of cookware.

If two pots or pans are placed very close together on the cooking surface, the touchscreen display may show them as one item of cookware.

Move the two items away from each other until the touchscreen display depicts them separately.

There is one item of cookware on the cooking surface. However, the touchscreen display is showing two or more.

The base of the cookware may be deformed or embossed, or the cookware may not be suitable for induction cooking.

Confirm that the base of the cookware is flat. For information on the type, size and positioning of the cookware, see the section entitled → *"Cooking with Induction"*

Not every item of cookware that is on the cooking surface can be activated.

You can place up to 8 items of cookware on the cooking surface, but no more than 5 evenly distributed items can be used at the same time.

For information on positioning cookware, see the section entitled → *"Cooking with Induction"*.

You can cook with up to 3 items of cookware on one side. If there is cookware in the middle of the cooking surface or the cookware is too large, the number of active pots or pans is restricted.

For information on positioning cookware, see the section entitled → *"Cooking with Induction"*.

One of the items of cookware is not suitable for induction cooking. The  symbol appears in the touchscreen display next to the unsuitable pot or pan.

For information on which types of cookware can be used with an induction cooktop, see the section entitled → *"Cooking with Induction"*.

The appliance has exceeded its maximum power consumption.

The power level cannot be increased.

The appliance has reached its maximum power output.

Cooking Sensor mode is not available.

The appliance has reached its maximum power output.

To make Cooking Sensor mode available, switch off other cooking positions or reduce the power level of other items of cookware. Change how the items of cookware are distributed over the cooking surface. Check the installation.

If you use the appliance intensively, this may increase the required cooking times.

This may be due to the fact that internal safety mechanisms are preventing the cooktop from overheating.

Try moving the cookware to a different position.

Bubbles are forming with an uneven distribution within the cookware.

Depending on the power level that is selected, the type of cookware or the combination with other cookware, bubbles may form unevenly. This does not affect the temperature or the cooking process. For information on the type, size and positioning of the cookware, see the section entitled → *"Cooking with Induction"*.

Cleaning

How do I clean the cooktop?

You can achieve the best results by using special glass-ceramic cleaning products. Do not use harsh or abrasive cleaning products, dishwasher detergent (concentrated) or scouring pads. For more information on cleaning and caring for your cooktop, see the section entitled → *"Cleaning and Maintenance"*

Home network

Why will the cooktop not connect to the home network after the WPS button has been pressed on the router?

Once the "Connect automatically" option has been selected, press the WPS button on the router within the next 2 minutes.

If this time has already elapsed, repeat the connection procedure. If the problems persist, restore the appliance to factory settings; see the section entitled → *"Basic Settings"*.

Why is my mobile device not logging into the Home Connect network?

Use the SSID "HomeConnect" and password "HomeConnect" to connect.

Make sure that you have entered all the characters correctly and that you have used upper and lower case in the relevant places.

Troubleshooting

If a problem or fault occurs in the appliance, instructions, alerts, warnings or fault messages will be shown on the display.

⚠ CAUTION

Repairs should only be done by an authorized servicer. Improper repair of your appliance may result in risk of severe physical injury or death.

Notes

- The top line of the display lights up red.
- A fault code is displayed with some fault messages (e.g. [E0513])
- If a fault occurs, the appliance will not switch to standby mode.
- For more information, see the section entitled → *"Frequently-asked questions and answers (FAQ)"*

Warnings and fault messages

Warnings are displayed if an internal fault has occurred that will compromise use of the cooktop.

Follow the instructions in the display and touch the symbol to return to the main screen.

Fault messages are displayed if an internal fault or malfunction has occurred that makes it impossible to use the cooktop.

Disconnect the appliance from the power supply and then wait for a few seconds before reconnecting it. If the message reappears, contact Customer Support.

Please state the fault code, as well as the complete model number and serial number (or FD) from the rating label when you call Customer Support.

Tips

Problem	Solution
The cooktop will not switch on.	Use other electrical appliances to check whether a short circuit has occurred in the power supply. Make sure that the appliance has been connected as shown in the circuit diagram. If you are unable to rectify the fault, contact Customer Support.
The touchscreen display is not responding or has frozen.	The control panel is damp or there is something on it. Dry the control panel or remove the object.
The power level for the cooking position cannot be increased.	The cooktop's total power output has been limited. If a very large item of cookware is being used, this may have an effect on the maximum power level for that half of the cooktop. Reposition the cookware.
An audible signal sounds when there is an object on the touchscreen display.	Remove the object and reset the cooktop. Do not place hot cookware on the control panel.
The cooktop responds in an unusual manner or cannot be operated properly.	Switch off the appliance using the mains fuse or the circuit breaker in the fuse box. Wait a few seconds before reconnecting the appliance.
The electronics have overheated and switched off the affected cooking position. The electronics have overheated and all the cooking positions have been switched off.	Wait until the electronics have cooled down sufficiently. When the fault code on the display goes out, you can resume cooking.
There is hot cookware near the control panel. The cooking position has been switched off to protect the electronics.	Remove the cookware that is causing the problem. Wait a few seconds. When the fault code on the display disappears, you can resume cooking.
The cooking position has overheated and has been switched off to protect the work surface.	Wait until the electronics have cooled down sufficiently before switching the cooking position on again.
The transfer settings function cannot be activated.	The active cookware has been removed from its position and cookware of a different size has been placed there. Test with the same item of cookware. Acknowledge the fault code by touching any of the touch buttons. You can cook as usual without using the transfer settings function. Contact Customer Support.
The cooktop has been in continuous operation for a long time.	The automatic safety switch-off function has been activated. See the section entitled → <i>"Basic Settings"</i>
The cooking sensor has overheated and the cooking position has been switched off. E8202	Wait until the cooking sensor has cooled down sufficiently before activating the function again.
The cooking sensor has overheated and the adjacent cooking positions have been switched off. E8203	If you are not using the cooking sensor, remove it from the cookware and keep it away from the other cooking positions and sources of heat. Switch the cooking positions back on.
The battery in the cooking sensor is almost drained. E8204	Replace the 3 V CR2032 battery. See the section entitled → <i>"Wireless Cooking Sensor"</i>
The connection to the cooking sensor has been broken. E8205	Switch the function off and on again.
The cooking sensor is faulty. E8206	Contact Customer Support.
The cooking sensor indicator will not light up and the cooking sensor is not responding.	Replace the 3 V CR2032 battery. See the section entitled → <i>"Wireless Cooking Sensor"</i> If this does not solve the problem, touch and hold the symbol on the cooking sensor for 8-10 seconds and then reconnect the cooking sensor to the cooktop. See the section entitled → <i>"Wireless Cooking Sensor"</i> If the problem persists, contact Customer Support.
The sensor indicator flashes twice. The battery in the cooking sensor is almost drained. You may be interrupted the next time you cook by the battery running out.	Replace the 3 V CR2032 battery. See the section entitled → <i>"Wireless Cooking Sensor"</i>

Problem	Solution
The sensor indicator flashes three times. The connection to the cooking sensor has been broken.	Touch and hold the symbol on the cooking sensor for 8-10 seconds and then reconnect the cooking sensor to the cooktop. See the section entitled → "Wireless Cooking Sensor"
The cooktop is unable to connect to your home network or the hood. <i>E 70 10</i>	Acknowledge the fault code by touching any of the touch buttons. You can cook as usual without a connection. If this code is displayed again, contact Customer Support.
The operating voltage is incorrect/outside of the normal operating range. <i>E9000/E90 10</i>	Contact your electricity utility provider.
The cooktop is not connected properly. <i>U400</i>	Disconnect the cooktop from the power supply. Make sure that it has been connected as shown in the circuit diagram.

Demo mode

If the  symbol appears at the top of the display, this means that demo mode is activated. The appliance will not heat up. Disconnect the appliance from the power supply and then wait for a few seconds before reconnecting it. Then deactivate demo mode in the basic settings menu within the next 3 minutes. See the section entitled → "Basic Settings"

How to Obtain Warranty Service

To obtain warranty service for your Product, you should contact the nearest THERMADOR® authorized servicer.

E number and FD number:

When you contact Service, please have the Model (E) number and the FD number for your appliance available. You can find the identification plate with these numbers on the underside of the appliance and in the appliance pass. To avoid having to search for this information when you need it, you can enter your appliance data and the customer support telephone number here.

E-Nr.	FD-Nr.

Customer Service 

Questions? Please contact us. We look forward to hearing from you!

1-800-735-4328

www.thermador.com

1901 Main Street, Suite 600
Irvine, CA 92614

STATEMENT OF LIMITED PRODUCT WARRANTY

What this Warranty Covers & Who it Applies to

The limited warranty provided by BSH Home Appliances Corporation ("BSH") in this Statement of Limited Product Warranty applies only to the THERMADOR® appliance ("Product") sold to you, the first using purchaser, provided that the Product was purchased:

- For your normal, household (non-commercial) use, and has in fact at all times only been used for normal household purposes.
- New at retail (not a display, "as is", or previously returned model), and not for resale, or commercial use.
- Within the United States or Canada, and has at all times remained within the country of original purchase.

The warranties stated herein apply to the original purchaser of the product warranted herein and to each succeeding owner of the product purchased for ordinary home use during the term of the warranty.

Please make sure to return your registration card; while not necessary to effectuate warranty coverage, it is the best way for BSH to notify you in the unlikely event of a safety notice or product recall.

How Long the Warranty Lasts

BSH warrants that the Product is free from defects in materials and workmanship for a period of seven hundred and thirty (730) days from the date of purchase. The foregoing timeline begins to run upon the date of purchase, and shall not be stalled, tolled, extended, or suspended, for any reason whatsoever.

This Product is also warranted to be free from *cosmetic* defects in material and workmanship (such as scratches of stainless steel, paint/porcelain blemishes, chip, dents, or other damage to the finish of the Product), for a period of sixty (60) days from the date of purchase or closing date for new construction. This *cosmetic* warranty excludes slight color variations due to inherent differences in painted and porcelain parts, as well as differences caused by kitchen lighting, product location, or other similar factors. This *cosmetic* warranty specifically excludes any display, floor, "As Is", or "B" stock appliances.

Repair/Replace as Your Exclusive Remedy

During this warranty period, BSH or one of its authorized service providers will repair your Product without charge to you (subject to certain limitations stated herein) if your Product proves to have been manufactured with a defect in materials or workmanship. If reasonable attempts to repair the Product have been made without success, then BSH will replace your Product (upgraded models may be available to you, in BSH's sole discretion, for an additional charge). All removed parts and components shall become the property of BSH at its sole option. All replaced and/or repaired parts shall assume the identity of the original part for purposes of this warranty and this warranty shall not be extended with respect to such parts. BSH's sole liability and responsibility hereunder is to repair manufacturer-defective Product only, using a BSH-authorized service provider during normal business hours. For safety and property damage concerns, BSH highly recommends that you do not attempt to repair the Product yourself, or use an un-authorized servicer; BSH will have no responsibility or liability for repairs or work performed by a non-authorized servicer. If you choose to have someone other than an authorized service provider work on your Product, THIS WARRANTY WILL AUTOMATICALLY BECOME NULL AND VOID. Authorized service providers are those persons or companies that have been specially trained on BSH products, and who possess, in BSH's opinion, a superior reputation for customer service and technical ability (note that they are independent entities and are not agents, partners, affiliates or representatives of BSH). Notwithstanding the foregoing, BSH will not incur any liability, or have responsibility, for the Product if it is located in a remote area (more than 100 miles from an authorized service provider) or is reasonably inaccessible, hazardous, threatening, or treacherous locale, surroundings, or environment; in any such event, if you request, BSH would still pay for labor and parts and ship the parts to the nearest authorized service provider, but you would still be fully liable and responsible for any travel time or other special charges by the service company, assuming they agree to make the service call.

Out of Warranty Product

BSH is under no obligation, at law or otherwise, to provide you with any concessions, including repairs, pro-rates, or Product replacement, once this warranty has expired.

Warranty Exclusions

The warranty coverage described herein excludes all defects or damage that are not the direct fault of BSH, including without limitation, one or more of the following:

- Use of the Product in anything other than its normal, customary and intended manner (including without limitation, any form of commercial use, use or storage of an indoor product outdoors, use of the Product in conjunction with air or water-going vessels).
- Any party's willful misconduct, negligence, misuse, abuse, accidents, neglect, improper operation, failure to maintain, improper or negligent installation, tampering, failure to follow operating instructions, mishandling, unauthorized service (including self-performed "fixing" or exploration of the appliance's internal workings).
- Adjustment, alteration or modification of any kind.
- A failure to comply with any applicable state, local, city, or county electrical, plumbing and/or building codes, regulations, or laws, including failure to install the product in strict conformity with local fire and building codes and regulations.
- Ordinary wear and tear, spills of food, liquid, grease accumulations, or other substances that accumulate on, in, or around the Product.
- Any external, elemental and/or environmental forces and factors, including without limitation, rain, wind, sand, floods, fires, mud slides, freezing temperatures, excessive moisture or extended exposure to humidity, lightning, power surges, structural failures surrounding the appliance, and acts of God.

In no event shall BSH have any liability or responsibility whatsoever for damage to surrounding property, including cabinetry, floors, ceilings, and other structures or objects around the Product. Also excluded from this warranty are Products on which the serial numbers have been altered, defaced, or removed; service visits to teach you how to use the Product, or visits where there is nothing wrong with the Product; correction of installation problems (you are solely responsible for any structure and setting for the Product, including all electrical, plumbing or other connecting facilities, for proper foundation/flooring, and for any alterations including without limitation cabinetry, walls, floors, shelving, etc.); and resetting of breakers or fuses.

TO THE EXTENT ALLOWED BY LAW, THIS WARRANTY SETS OUT YOUR EXCLUSIVE REMEDIES WITH RESPECT TO PRODUCT, WHETHER THE CLAIM ARISES IN CONTRACT OR TORT (INCLUDING STRICT LIABILITY, OR NEGLIGENCE) OR OTHERWISE. THIS WARRANTY IS IN LIEU OF ALL OTHER WARRANTIES, WHETHER EXPRESS OR IMPLIED. ANY WARRANTY IMPLIED BY LAW, WHETHER FOR MERCHANTABILITY OR FITNESS FOR A PARTICULAR PURPOSE, OR OTHERWISE, SHALL BE EFFECTIVE ONLY FOR THE PERIOD THAT THIS EXPRESS LIMITED WARRANTY IS EFFECTIVE. IN NO EVENT WILL THE MANUFACTURER BE LIABLE FOR CONSEQUENTIAL, SPECIAL, INCIDENTAL, INDIRECT, "BUSINESS LOSS", AND/OR PUNITIVE DAMAGES, LOSSES, OR EXPENSES, INCLUDING WITHOUT LIMITATION TIME AWAY FROM WORK, HOTELS AND/OR RESTAURANT MEALS, REMODELLING EXPENSES

IN EXCESS OF DIRECT DAMAGES WHICH ARE DEFINITELY CAUSED EXCLUSIVELY BY BSH, OR OTHERWISE. SOME STATES DO NOT ALLOW THE EXCLUSION OR LIMITATION OF INCIDENTAL OR CONSEQUENTIAL DAMAGES, AND SOME STATES DO NOT ALLOW LIMITATIONS ON HOW LONG AN IMPLIED WARRANTY LASTS, SO THE ABOVE LIMITATIONS MAY

NOT APPLY TO YOU. THIS WARRANTY GIVES YOU SPECIFIC LEGAL RIGHTS, AND YOU MAY ALSO HAVE OTHER RIGHTS WHICH VARY FROM STATE TO STATE. No attempt to alter, modify or amend this warranty shall be effective unless authorized in writing by an officer of BSH.

THERMADOR® Support

Service

We realize that you have made a considerable investment in your kitchen. We are dedicated to supporting you and your appliance so that you have many years of creative cooking.

Please do not hesitate to contact our STAR® Customer Support Department if you have any questions or in the unlikely event that your THERMADOR® appliance needs service. Our service team is ready to assist you.

USA

800-735-4328

www.thermador.com/support

Canada

800-735-4328

www.thermador.ca

Parts and Accessories

Parts, filters, descalers, stainless steel cleaners and more can be purchased in the THERMADOR® eShop or by phone.

USA

<http://store.thermador.com/us>

Canada

- If you live in any of the Atlantic provinces, Ontario, or Québec contact:

Marcone

1.800.287.1627

- If you live in any of the Territories, Manitoba, Saskatchewan, Alberta, or British Columbia contact:

Reliable Parts

1.800.663.6060



1901 MAIN STREET, SUITE 600 IRVINE, CA 92614 // 1-800-735-4328 // WWW.THERMADOR.COM
© 2018 BSH HOME APPLIANCES CORPORATION
9001349121 en-us 981217