

18 x 35-Inch Telescoping Duct Cover for Professional Chimney Wall Hood

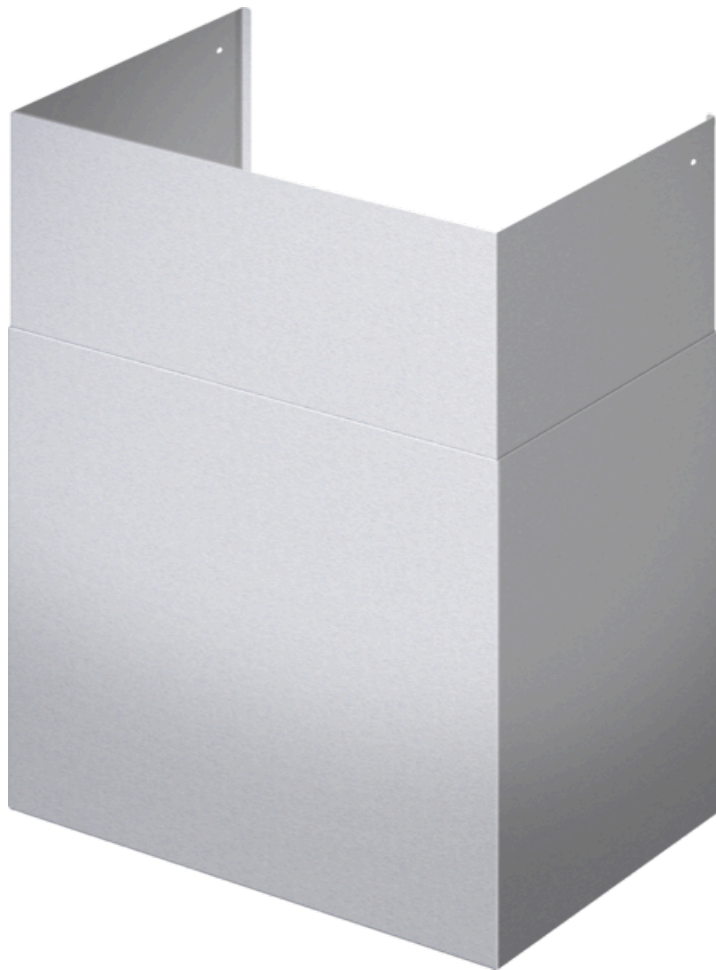

Product Features



Notes: Please refer to installation instructions. Installation instructions are available at www.thermador.com. Specifications are correct at the time of printing. Thermador reserves the right to change product specifications and design at any time, without notice.

1 800 735 4328 | WWW.THERMADOR.COM | 1901 Main Street, Suite 600 Irvine, CA 92614

©2020 BSH HOME APPLIANCES CORPORATION, ALL RIGHTS RESERVED LITHO DATE: 05/2020

18 x 35-Inch Telescoping Duct Cover for Professional Chimney Wall Hood

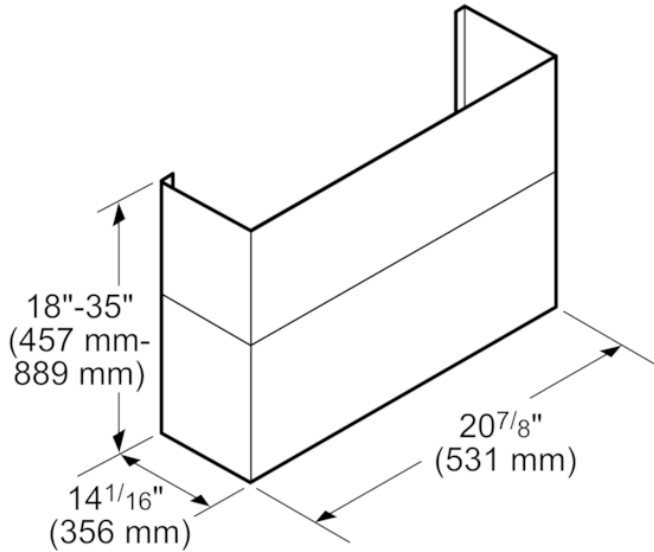

Product Features

Product group	Accessory
Brand	Thermador
SKU	CHMHP36TW
Internal article number	00000000011030266
EAN code	825225940531
Product packaging dimensions (HxWxD) (in)	19 7/8" x 23 5/8" x 16 7/8"
Net weight (lbs)	20
Gross weight (lbs)	20
UPC code	825225940531
Name of product image	MCSA00782422_CHMHP36TSN_def.jpg

Technical Specification

Notes: Please refer to installation instructions. Installation instructions are available at www.thermador.com. Specifications are correct at the time of printing. Thermador reserves the right to change product specifications and design at any time, without notice.

1 800 735 4328 | WWW.THERMADOR.COM | 1901 Main Street, Suite 600 Irvine, CA 92614

©2020 BSH HOME APPLIANCES CORPORATION, ALL RIGHTS RESERVED LITHO DATE: 05/2020