

2-Foot Rectangular Duct Downdraft

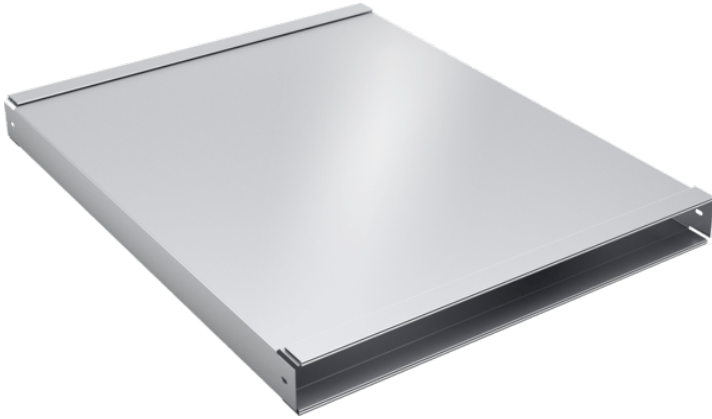

Product Features

Performance

- Allows three ways to exhaust at downdraft housing at sides or bottom
- For use with remote or inline blower applications
- CVTRECT2 transition needed to directly connect to downdraft housing
- See installation guide for details

Design

- Slim rectangular duct that is 2' x 1-7/8" x 19"
- Designed for use with UCVM30RS, UCVM36RS, UCVP36RS downdrafts
- Durable galvanized steel construction
- Can be attached to CVTSIDE6, CVTSIDE8, CVTSIDE10 transitions
- Duct length can be modified to suit your installation needs

Notes: Please refer to installation instructions. Installation instructions are available at www.thermador.com. Specifications are correct at the time of printing. Thermador reserves the right to change product specifications and design at any time, without notice.

1 800 735 4328 | WWW.THERMADOR.COM | 1901 Main Street, Suite 600 Irvine, CA 92614

©2020 BSH HOME APPLIANCES CORPORATION, ALL RIGHTS RESERVED LITHO DATE: 11/2020

2-Foot Rectangular Duct Downdraft

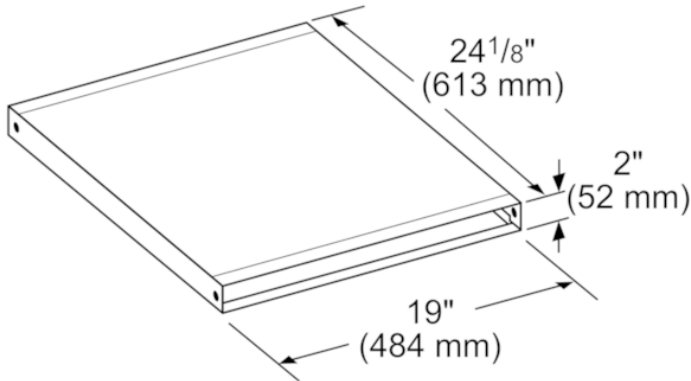

measurements in inches (mm)

Product Features

	Accessory
Brand	Thermador
SKU	CVDUCT2
Internal article number	00000000011026318
EAN code	825225920762
	7
	8
Standard number of units per pallet	30
UPC code	825225920762
Product image	MCSA02477480_i3925_1851140_CVDUCT2_de

Technical Specification

Notes: Please refer to installation instructions. Installation instructions are available at www.thermador.com. Specifications are correct at the time of printing. Thermador reserves the right to change product specifications and design at any time, without notice.

1 800 735 4328 | WWW.THERMADOR.COM | 1901 Main Street, Suite 600 Irvine, CA 92614

©2020 BSH HOME APPLIANCES CORPORATION, ALL RIGHTS RESERVED LITHO DATE: 11/2020