

Liner for Professional Series Custom Insert LINER30

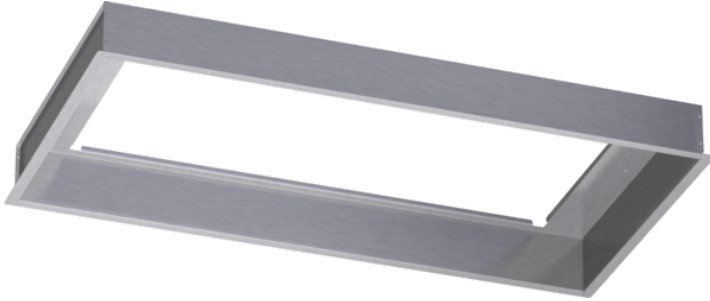

Product Features

Stainless steel custom hood liner protects the exterior base of the custom cabinetry

The liner completes Thermador's Professional Series custom insert installation

The liner has pre-drilled mounting holes to make installation easy

Wipes clean easily

For use with VCI2xxDS Series custom hood inserts

Always refer to installation manual for detailed instructions

Notes: Please refer to installation instructions. Installation instructions are available at www.thermador.com. Specifications are correct at the time of printing. Thermador reserves the right to change product specifications and design at any time, without notice.

1 800 735 4328 | WWW.THERMADOR.COM | 1901 Main Street, Suite 600 Irvine, CA 92614

©2020 BSH HOME APPLIANCES CORPORATION, ALL RIGHTS RESERVED LITHO DATE: 05/2020

Liner for Professional Series Custom Insert LINER30

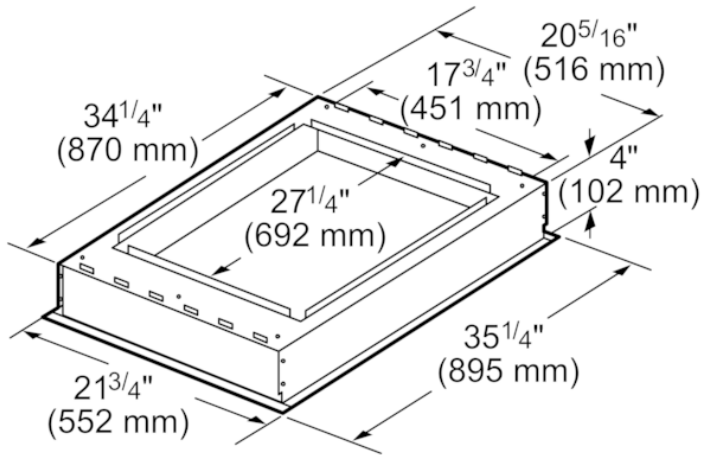

measurements in inches and mm

Product Features

Product group	Accessory
Brand	Thermador
SKU	LINER30
Internal article number	LINER30
EAN code	825225883647
Net weight (lbs)	7
Gross weight (lbs)	11
UPC code	825225883647
Name of product image	MCSA044014_LINER36_def.jpg

Technical Specification

Notes: Please refer to installation instructions. Installation instructions are available at www.thermador.com. Specifications are correct at the time of printing. Thermador reserves the right to change product specifications and design at any time, without notice.

1 800 735 4328 | WWW.THERMADOR.COM | 1901 Main Street, Suite 600 Irvine, CA 92614

©2020 BSH HOME APPLIANCES CORPORATION, ALL RIGHTS RESERVED LITHO DATE: 05/2020