

Liner for Professional Series Custom Insert LINER48

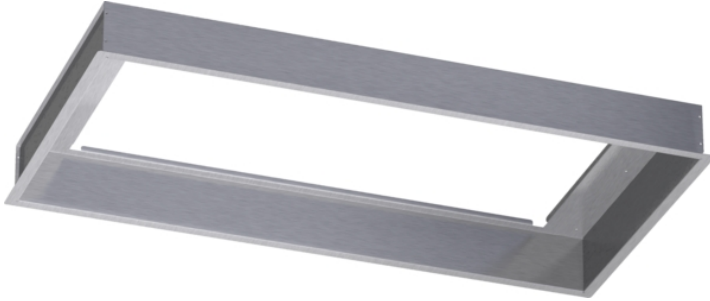

Product Features

Stainless steel custom hood liner protects the exterior base of the custom cabinetry

Stainless steel custom hood liners to protect the exterior base of custom insert

Custom hood liner completes custom insert installation

Wipes clean easily

For use with VCINxxJP Series custom hood inserts

Use the EXTNCB25 Blower Cable Connection Accessory for install with select hoods. Separate purchase required.

Notes: Please refer to installation instructions. Installation instructions are available at www.thermador.com. Specifications are correct at the time of printing. Thermador reserves the right to change product specifications and design at any time, without notice.

1 800 735 4328 | WWW.THERMADOR.COM | 1901 Main Street, Suite 600 Irvine, CA 92614

©2022 BSH HOME APPLIANCES CORPORATION, ALL RIGHTS RESERVED LITHO DATE: 06/2022

Liner for Professional Series Custom Insert LINER48

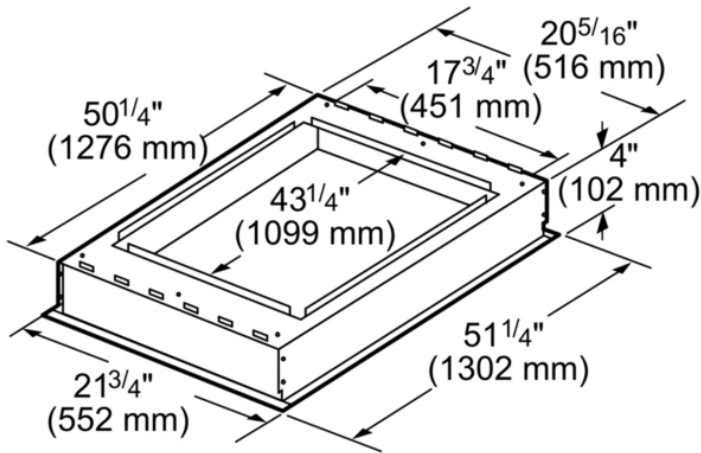

measurements in inches and mm

Product Features

	Accessory
Brand	Thermador
SKU	LINER48
Internal article number	LINER48
EAN code	825225883661
	24
	28
UPC code	825225883661
Product image	MCSA044014_LINER36_def.jpg

Technical Specification

Notes: Please refer to installation instructions. Installation instructions are available at www.thermador.com. Specifications are correct at the time of printing. Thermador reserves the right to change product specifications and design at any time, without notice.

1 800 735 4328 | WWW.THERMADOR.COM | 1901 Main Street, Suite 600 Irvine, CA 92614

©2022 BSH HOME APPLIANCES CORPORATION, ALL RIGHTS RESERVED LITHO DATE: 06/2022