

Recirculation Kit for Low-Profile Wall Hoods
RECHMWB36

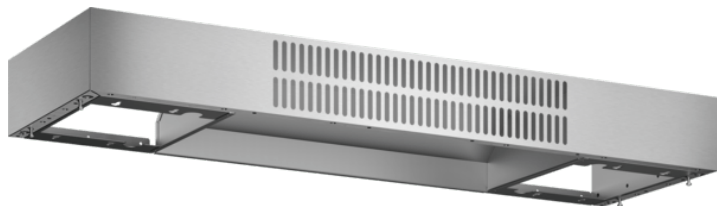

Product Features



Notes: Please refer to installation instructions. Installation instructions are available at www.thermador.com. Specifications are correct at the time of printing. Thermador reserves the right to change product specifications and design at any time, without notice.

1 800 735 4328 | WWW.THERMADOR.COM | 1901 Main Street, Suite 600 Irvine, CA 92614

©2020 BSH HOME APPLIANCES CORPORATION, ALL RIGHTS RESERVED LITHO DATE: 03/2020

Recirculation Kit for Low-Profile Wall Hoods
RECHMWB36



measurements in inches (mm)

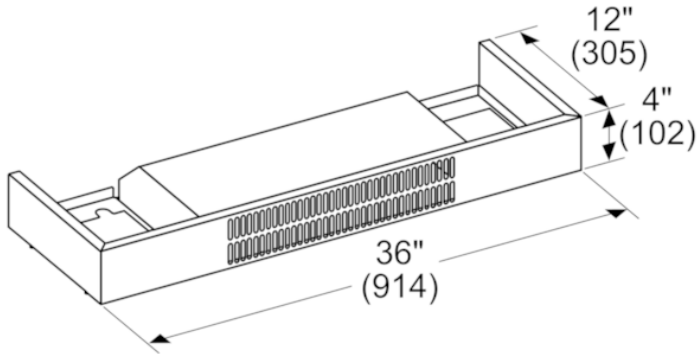

Product Features

Product group	Accessory
Brand	Thermador
SKU	RECHMWB36
Internal article number	00000000000718499
EAN code	825225955900
Product packaging dimensions (HxWxD) (in)	9" x 38 1/2" x 16 1/2"
Net weight (lbs)	16
Gross weight (lbs)	18
Standard number of units per pallet	24
UPC code	825225955900
Name of product image	MCSA03292323_J5561_2645803_RECHMWB36_ST

Technical Specification

Notes: Please refer to installation instructions. Installation instructions are available at www.thermador.com. Specifications are correct at the time of printing. Thermador reserves the right to change product specifications and design at any time, without notice.

1 800 735 4328 | WWW.THERMADOR.COM | 1901 Main Street, Suite 600 Irvine, CA 92614

©2020 BSH HOME APPLIANCES CORPORATION, ALL RIGHTS RESERVED LITHO DATE: 03/2020