

PRD364NLGU 36-INCH DUAL-FUEL PRO GRAND® RANGE WITH GRILL

PROFESSIONAL SERIES, COMMERCIAL-DEPTH, PORCELAIN COOKTOP SURFACE



FEATURES & BENEFITS

- ★ - Patented Pedestal Star® Burner with QuickClean Base® designed for easy surface cleaning and superior heat spread for any size pan
- ★ - Powerful 22,000 BTU (NG) burner (front right)
- ★ - Precision simmering capabilities as low as 100°F (375 BTU) with 4 ExtraLow® Simmer burners
- ★ - SoftClose® hinges for ultra smooth closing of the oven door
- ★ - Superfast 2-hour self-clean mode—fastest in the industry

TECHNICAL DETAILS

Circuit Breaker (A)	50 A
Volts (V)	240 / 208 V
Frequency (Hz)	60 Hz
Plug Type	No Plug
Power Cord Length (in)	Purchase Separately
Energy Source	Gas and Electric
Gas Type	Natural Gas 15 mbar (USA)
Alternative Gas Type	Liquid Gas 27, 5 mbar (USA)

SEE PAGE 2 FOR OPTIONAL ACCESSORIES

GENERAL PROPERTIES

Oven Capacity	5.7 cu. ft.
Cooking Modes - Main / Large Cavity	
Bake, Convection Bake, Broil, Convection Broil, Roast, Convection Roast, Self Clean, Warm	
Cooking Modes - Small Cavity	N/A
Programs	
Heating-up Control, Meat Probe, Sabbath Function	
Cleaning Type	Self Clean
Type of Grate	Continuous Cast Iron
Controls	Metal Knobs and LCD Display
Warming Drawer	No
Sealed Burners	Yes

OVEN PERFORMANCE

Bake Power	2,400 W
Broil Power	4,000 W
Convection Power	2,750 W

BURNER PERFORMANCE

Total Number of Cooktop Burners	4 + Grill
Total Cooktop BTU	72,000 (NG)
Power of Front Left Burner BTU	18,000-3,000 XLO (NG)
Power of Back Left Burner BTU	18,000-3,000 XLO (NG)
Power of Back Center Burner BTU	N/A
Power of Front Center Burner BTU	N/A
Power of Center 12" Electric Griddle (W)	N/A
Power of Center 12" Electric Grill (W)	2,000 W
Power of Far Right 12" Electric Griddle (W)	N/A
Power of Back Right Burner BTU	18,000-3,000 XLO (NG)
Power of Front Right Burner BTU	22,000-3,000 XLO (NG)

DIMENSIONS & WEIGHT

Overall Appliance Dimensions (HxWxD) (in)	35 7/8"–36 3/4" x 35 15/16" x 28 1/2"
Required Cutout Size (HxWxD) (in)	35 7/8"–36 3/4" x 36" x 24"–25 1/8"
Adjustable Range Height (in.)	7/8"
Net Weight (lbs)	360 lbs

ACCESSORIES (INCLUDED)

1 X Nozzle Set for Liquid Gas, 3 X Telescopic Rack, 1 X Temperature Sensor, 1 X Island Trim, 1 X Grill Plate, 1 X Broiler Pan

WARRANTY







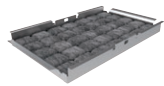
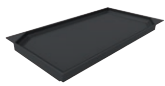

Limited Warranty, Entire Appliance, Parts and Labor	2 Year
---	--------

PRD364NLGU 36-INCH DUAL-FUEL PRO GRAND® RANGE WITH GRILL

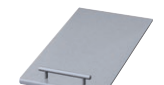

PROFESSIONAL SERIES, COMMERCIAL-DEPTH, PORCELAIN COOKTOP SURFACE

ACCESSORIES (OPTIONAL)

	PABRICKBKN Black Ceramic Briquettes with Basket		PAGRIDDLEN Griddle for Indoor Electric Grill		PAGRIDDLE Griddle
	PA12LCVRN 12" Pro Grill Cover for Indoor Electric Grill		PA12CHPBLK 12" Cutting Board		PWOKRINGHC Wok Ring
	PA36JLBG 9" Low Backguard		PA36JTKG Toekick		PAKNOBLUNG Blue Knob Pro Grand Kit

36-INCH RANGE AND CUTOUT DIMENSIONS

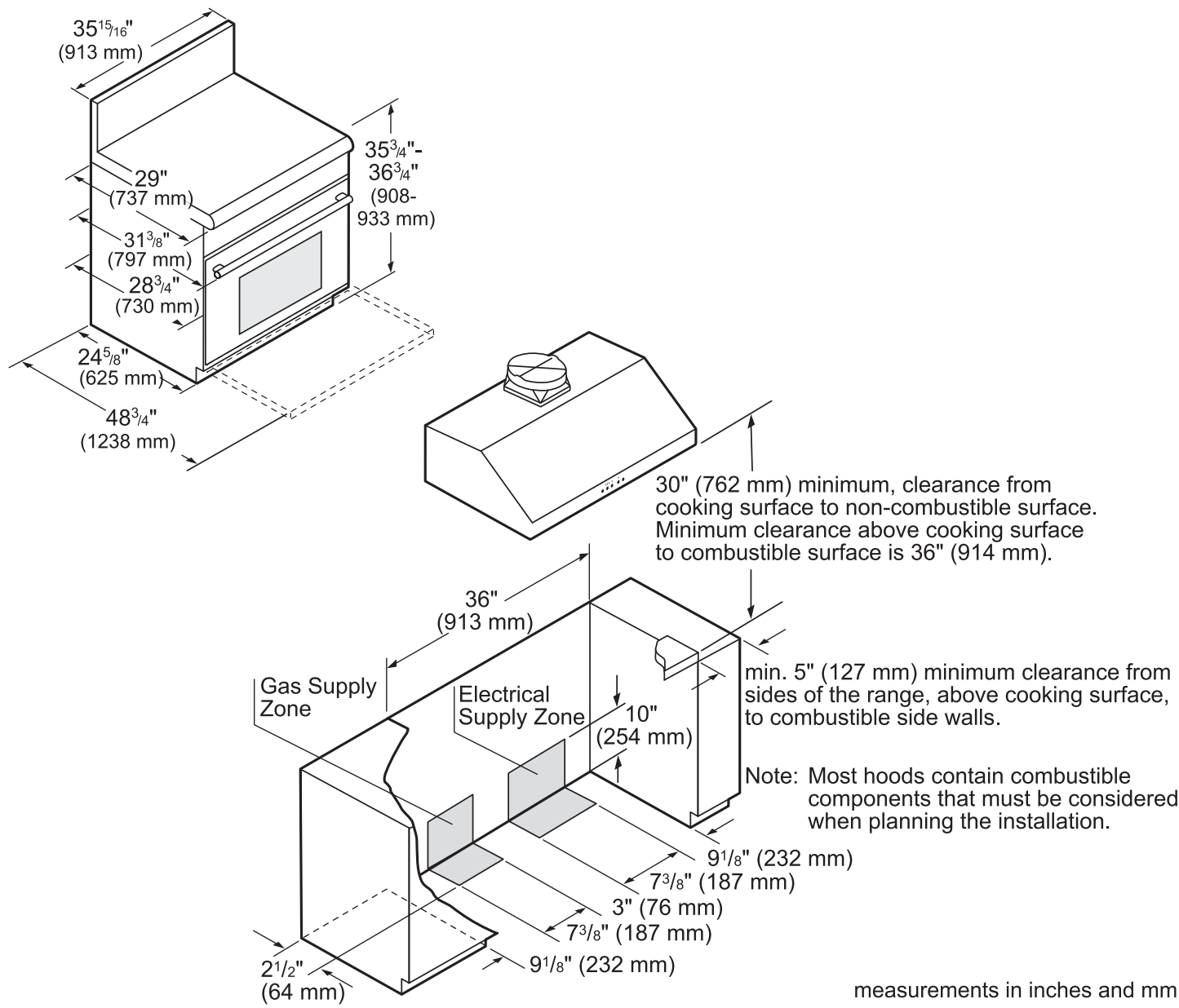

PRD364NLGU 36-INCH DUAL-FUEL PRO GRAND® RANGE WITH GRILL



PROFESSIONAL SERIES, COMMERCIAL-DEPTH, PORCELAIN COOKTOP SURFACE

36-INCH RANGE CUTOUT DIMENSIONS

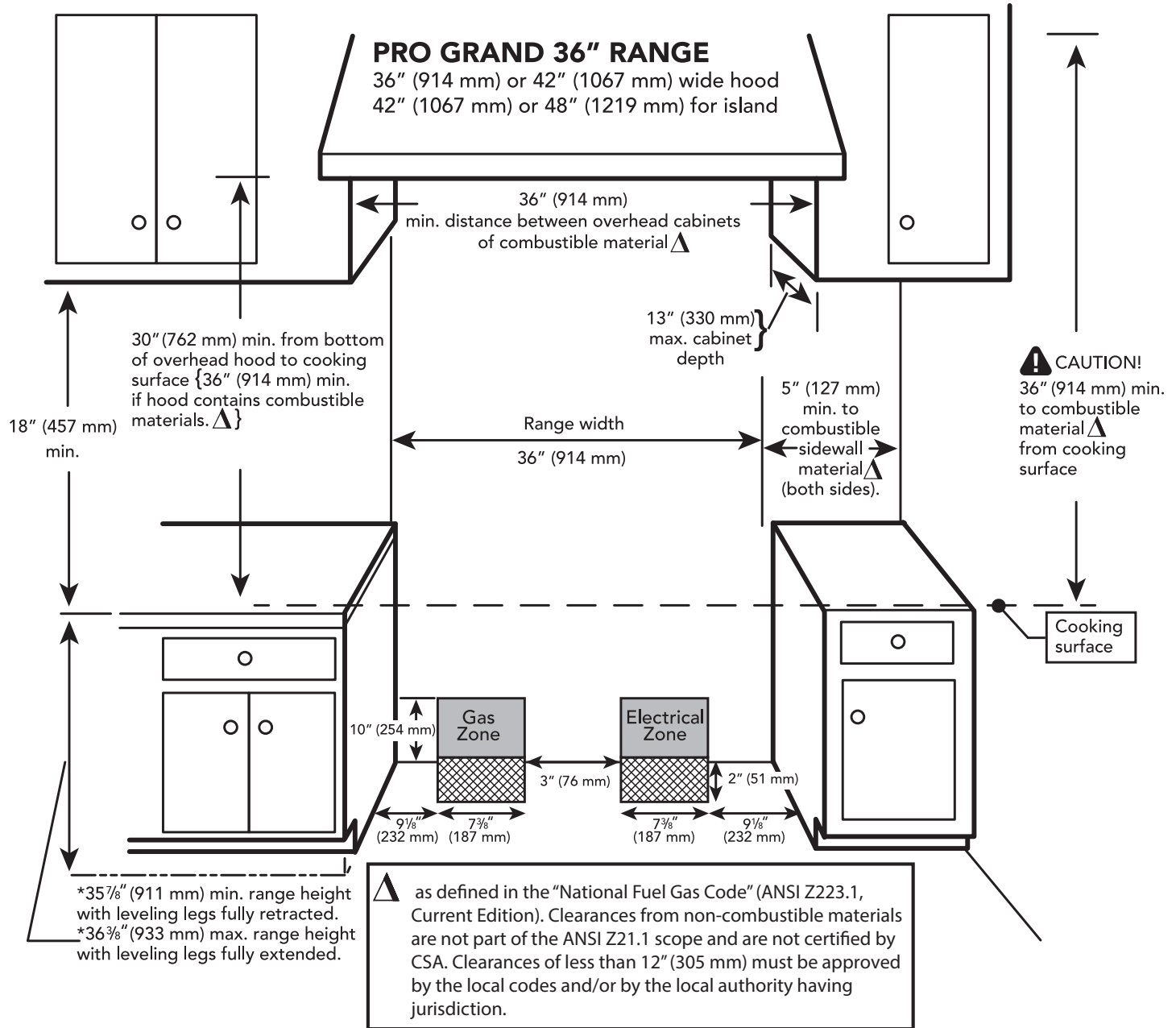

PRD364NLGU 36-INCH DUAL-FUEL PRO GRAND® RANGE WITH GRILL



PROFESSIONAL SERIES, COMMERCIAL-DEPTH, PORCELAIN COOKTOP SURFACE

36-INCH RANGE DIMENSIONS AND CLEARANCE REQUIREMENTS WITH "LOW BACK"

NOTE: A 36-inch minimum clearance is required between the top of the cooking surface and the bottom of an unprotected cabinet. A 30-inch clearance can be used when the bottom of the wood or metal cabinet is protected by not less than 1/4 inch of a flame retardant material covered with not less than No. 28 MSG sheet steel, 0.015 inch (0.4 mm) thick stainless steel, 0.024 inch (0.6 mm) aluminum, or 0.020 inch (0.5 mm) thick copper.

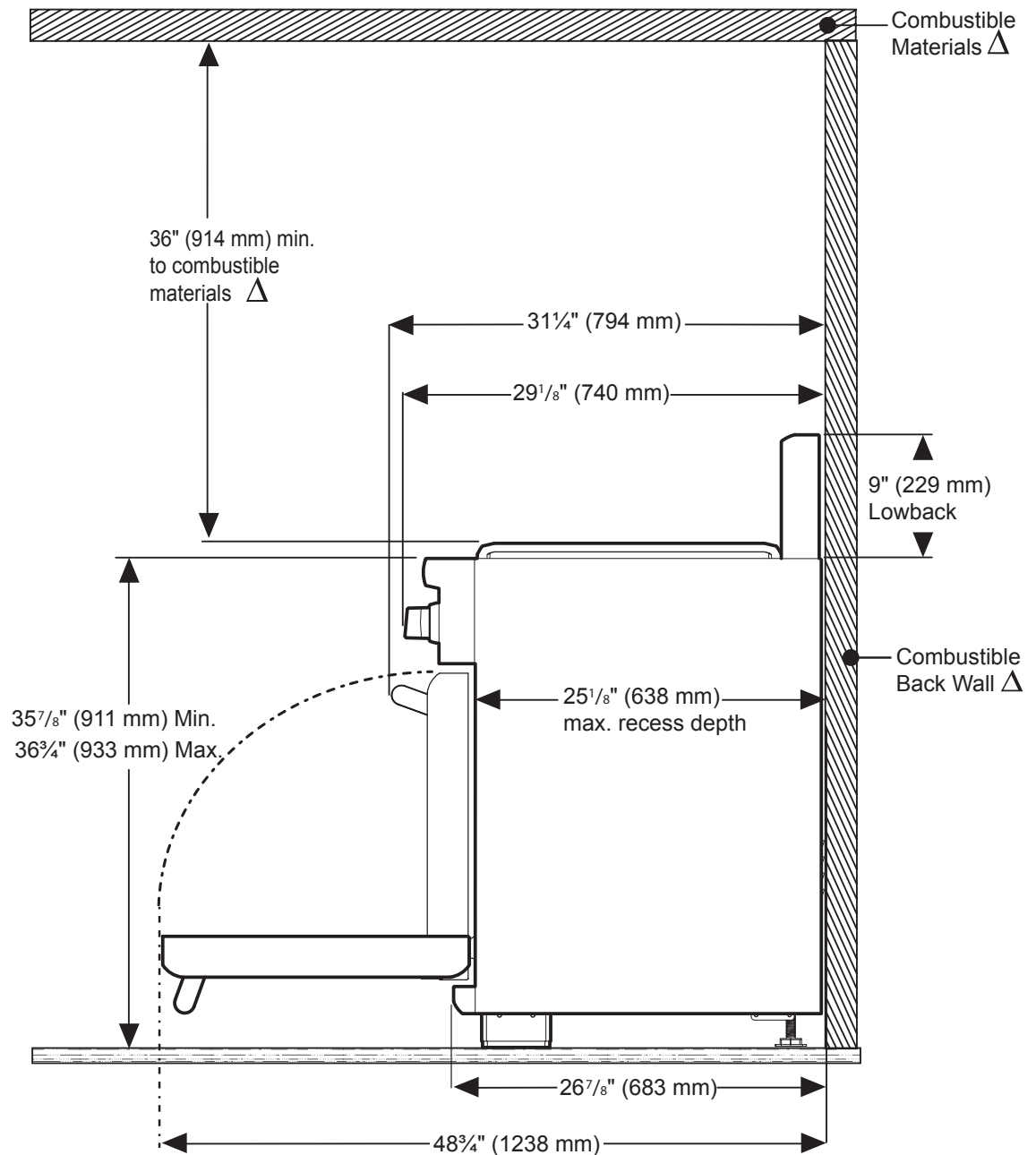

△ As defined in the "National Fuel Gas Code" (ANSI Z223.1, Current Edition). Clearances from non-combustible materials are not part of the ANSI Z21.1 scope and are not certified by CSA. Clearances of less than 12" (305 mm) must be approved by the local codes and/or by the local authority having jurisdiction.

PRD364NLGU 36-INCH DUAL-FUEL PRO GRAND® RANGE WITH GRILL

PROFESSIONAL SERIES, COMMERCIAL-DEPTH, PORCELAIN COOKTOP SURFACE



36-INCH RANGE DIMENSIONS AND CLEARANCE REQUIREMENTS WITH "FLUSH ISLAND TRIM"

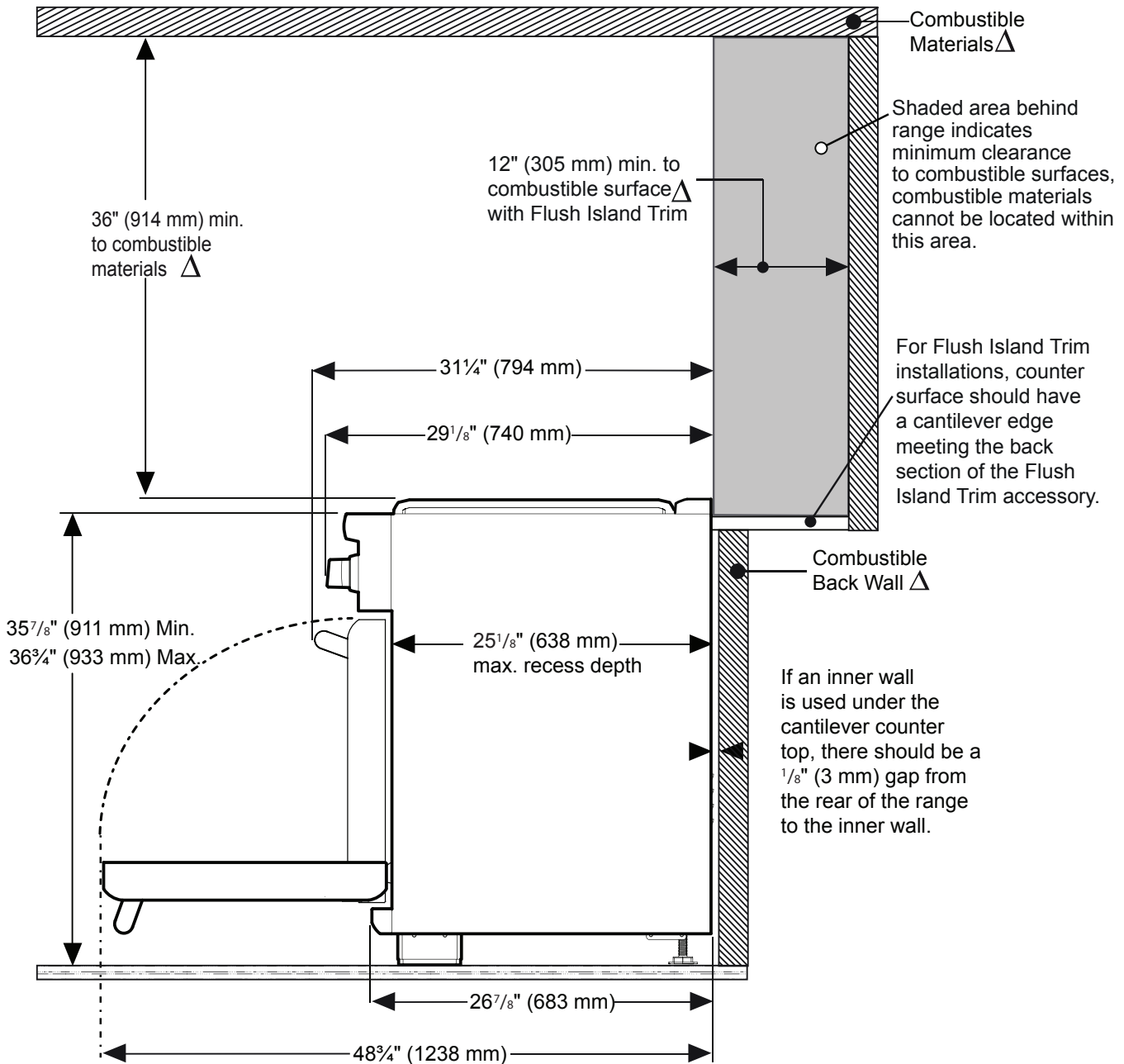

△ As defined in the "National Fuel Gas Code" (ANSI Z223.1, Current Edition). Clearances from non-combustible materials are not part of the ANSI Z21.1 scope and are not certified by CSA. Clearances of less than 12" (305 mm) must be approved by the local codes and/or by the local authority having jurisdiction.

These warranties give you specific legal rights and you may have other rights that vary from state to state. Full warranty and limited warranty from date of installation. For complete warranty details, refer to your Use & Care manual, or ask your dealer.

Specifications are for planning purposes only. Refer to installation instructions and consult your countertop supplier prior to making counter opening. Consult with a heating and ventilation engineer for your specific ventilation requirements. For the most detailed information, refer to installation instructions accompanying product or write to Thermador indicating the model number. Specifications are correct at time of printing. Thermador reserves the right to change product specifications or design without notice. Some models are certified for use in Canada. Thermador is not responsible for products that are transported from the U.S. for use in Canada.