

27" Masterpiece© Series Warming Drawer

WD27JS



WD27JS Stainless steel

INNOVATION

- NEW SoftClose® drawer door. Ultra smooth closing of the warming drawer. Thermador exclusive feature

PERFORMANCE

- Telescopic ball-bearing rails offer smooth handling and support up to 40 lbs
- Warming Mode with three convenient temperature settings
- Special Proof Mode
- Moisture selector controls humidity level in the drawer
- Concealed 450-watt heating element
- Spacious 2.3 cu.ft. cavity can hold and warm up to 20 dinner plates
- Drawer has open sides for easy and convenient access
- Automatic shut-off timer
- NEW Star-K certified

DESIGN

- NEW: side supports and door liner now in bold stainless steel design
- Built-in Warming Drawer is the perfect companion for any Thermador Wall Oven
- Premium touch control
- Blue digital display
- Modern angular design

825225898160

27" Masterpiece© Series Warming Drawer WD27JS

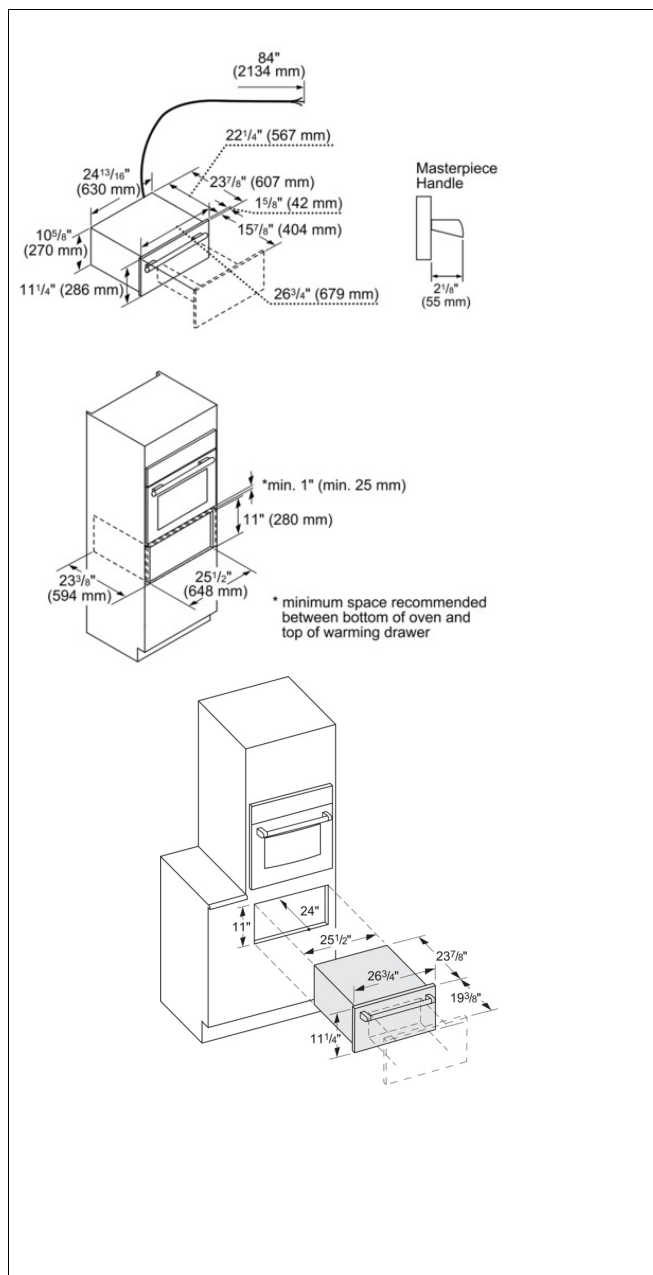

Product Features

Power output heating: 0.450
 Power Level: high, low, medium
 Type of control: illuminated, TouchControl Basic
 Temperature control: electronic
 Time control: electronic

Consumption and connection features

UPC code: 825225898160
 Product color: Stainless steel
 Alternative colors available:
 Watts (W): 450
 Current (A): 15
 Volts (V): 120
 Frequency (Hz): 60
 Approval certificates: UL
 Power cord length (in): 84"
 Power cord length (cm): 213.4
 Plug type: 120V-3 prong
 Required cutout size (HxWxD) (in): 11" x 25 1/2" x 24"
 Required cutout size (HxWxD) (mm): 280 x 648 x 610
 Overall appliance dimensions (HxWxD) (in): 11 1/4" x 26 3/4" x 23 7/8"
 Overall appliance dimensions (HxWxD) (mm): 285.8 x 679 x 607
 Product packaging dimensions (HxWxD) (in): 16 7/8" x 31" x 35 3/4"
 Net weight (lbs): 77
 Net weight (kg): 35.000
 Gross weight (lbs): 85
 Gross weight (kg): 39.000

2013-07-12