

36 INCH PROFESSIONAL FRENCH DOOR REFRIGERATOR

TRF3602

COOK LIKE A GOD

THOR
K I T C H E N[®]

USE & CARE MANUAL

USE AND CARE MANUAL

36 INCH PROFESSIONAL FRENCH DOOR REFRIGERATOR

TRF3602

THOR
K I T C H E N[®]



Thank you for choosing THOR KITCHEN. This refrigerator has been manufactured by Thor Group , 4651 E Airport Drive,Ontario, CA 91761.This manual contains all the information you will need to install / use your refrigerator correctly and safely. Please read all the instructions prior using the appliance, and keep this manual in a secure place for future reference.Do not remove the attached adhesive identification label containing code, model number, manufacturer and other information from the refrigerator This label will be used by the THOR KITCHEN authorized service representative in the event that your refrigerator needs servicing.

ENVIRONMENTAL ADVICE

The packaging material used is recyclable; we recommend that you separate plastic, paper and cardboard and give them to recycling companies. To help preserve the environment, the refrigerant used in this product is R600a , which does not affect the ozone layer and has little impact on the greenhouse effect . According to **WEEE** guidelines (Waste of Electrical and Electronic Equipment), waste from electrical and electronic devices should be collected separately. If you need to dispose of this appliance in the future, **DO NOT** throw it away with the rest of your domestic garbage.Instead, please take the appliance to the nearest **WEEE** collection point, where available.

TABLE OF CONTENT

1 Safety warnings	
1.1 Warning	1-2
1.2 Meaning of safety warning symbols	3
1.3 Electricity related warnings	3
1.4 Warnings for using	4
1.5 Warnings for placement	4-5
1.6 Warnings for energy	5
1.7 Warnings for disposal	5
2 Proper use of the refrigerator	
2.1 Placement	6
2.2 Levelling feet	7
2.3 Levelling door	8
2.4 Door handles	9
2.5 Changing the Light	10
2.6 Starting to use	10
2.7 Energy saving tips	10
3 Structure and functions	
3.1 Key components	11
3.2 Functions	13
4 Maintenance and care of the refrigerator	
4.1 Overall cleaning	15
4.2 Cleaning of door dray	15
4.3 Cleaning of shelf	16
4.4 Cleaning of freezer lower drawer	16
4.5 Installing the Water Line	17
4.6 Defrosting	18
4.7 Out of operation	18
5 Troubleshooting	19

SAFETY WARNINGS

1.1 WARNING



WARNING: risk of fire / flammable materials

THIS appliance is intended to be used in household and similar applications such as staff kitchen areas in shops, offices and other working environments; farm houses and by clients in hotels, motels and other residential type environments; bed and breakfast type environments; catering and similar nonretail applications.

THIS appliance is not intended for use by persons (including children) with reduced physical, sensory or mental capabilities, or lack of experience and knowledge, unless they have been given supervision or instruction concerning use of the appliance by a person responsible for their safety.)

CHILDREN should be supervised to ensure that they do not play with the appliance. If the supply cord is damaged, it must be replaced by the manufacturer, its service agent or similarly qualified persons in order to avoid a hazard.

DO not store explosive substances such as aerosol cans with a flammable propellant in this appliance.

THE appliance has to be unplugged after use and before carrying out user maintenance on the appliance.

WARNING: Keep ventilation openings, in the appliance enclosure or in the built-in structure, clear of obstruction.

WARNING: Do not use mechanical devices or other means to accelerate the defrosting process, other than those recommended by the manufacturer.

WARNING: Do not damage the refrigerant circuit.

WARNING: Do not use electrical appliances inside the food storage compartments of the appliance, unless they are of the type recommended by the manufacturer.

WARNING: Please abandon the refrigerator according to local regulators for its use of flammable blowing gas and refrigerant.

WARNING: When positioning the appliance, ensure the supply cord is not trapped or damaged.

WARNING: Risk of child entrapment. Before you throw away your old refrigerator or freezer:

- Take off the doors.
- Leave the shelves in place so that children may not easily climb inside.

WARNING: Do not locate multiple portable socket-outlets or portable power supplies at the rear of the appliance.

DO not use extension cords or ungrounded two prong adapters.

THE refrigerator must be disconnected from the source of electrical supply before attempting the installation of accessory.

SAFETY WARNINGS

REFRIGERANT and cyclopentane foaming material used for the appliance are flammable. Therefore, when the appliance is scrapped, it shall be kept away from any fire source and be recovered by a special recovering company with corresponding qualification other than be disposed by combustion, so as to prevent damage to the environment or any other harm.

THE necessity that, for doors or lids fitted with locks and keys, the keys be kept out of the reach of children and not in the vicinity of the refrigerating appliance, in order to prevent children from being locked inside .



WARNING: To avoid a hazard due to instability of the appliance, it must be fixed in accordance with the instructions.

WARNING: Connect to potable water supply only. (Suitable for ice making machine)

TO Prevent A Child From Being Entrapped, Keep Out Of Reach Of Children And Not In The Vicinity Of Freezer (Or Refrigerator). (Suitable for products with locks)

SAFETY WARNINGS

1.2 Meaning of safety warning symbols

 Prohibition symbol	This is a prohibition symbol. Any in compliance with instructions marked with this symbol may result in damage to the product or endanger the personal safety of the user.
 Warning symbol	This is a warning symbol. It is required to operate in strict observance of instructions marked with this symbol; or otherwise damage to the product or personal injury may be caused.
 Note symbol	This is a cautioning symbol. Instructions marked with this symbol require special caution. Insufficient caution may result in slight or moderate injury, or damage to the product.

This manual contains lots of important safety information which shall be observed by the users.

1.3 Electricity related warnings

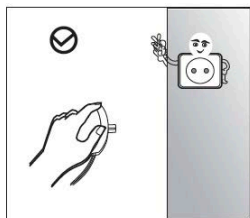

- Do not pull the power cord when pulling the power plug of the refrigerator. Please firmly grasp the plug and pull out it from the socket directly.
- To ensure safe use, do not damage the power cord or use the power cord when it is damaged or worn.

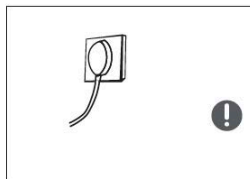

- Please use a dedicated power socket and the power socket shall not be shared with other electrical appliances.
- The power plug should be firmly contacted with the socket or else fires might be caused. Please ensure that the grounding electrode of the power socket is equipped with a reliable grounding line.

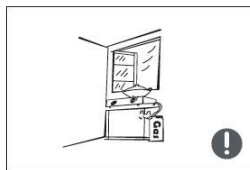

- Please turn off the valve of the leaking gas and then open the doors and windows in case of leakage of gas and other flammable gases.
- Do not unplug the refrigerator and other electrical appliances considering that spark may cause a fire.

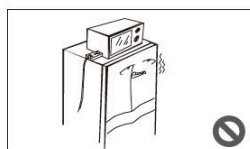

- Do not use electrical appliances on the top of the appliance, unless they are of the type recommended by the manufacturer.

SAFETY WARNINGS

1.4 Warnings for using

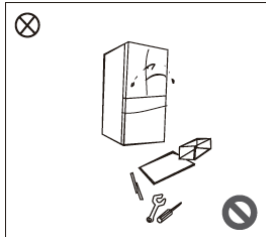

- Do not arbitrarily disassemble or reconstruct the refrigerator, nor damage the refrigerant circuit; maintenance of the appliance must be conducted by a specialist.
- Damaged power cord must be replaced by the manufacturer, its maintenance department or related professionals in order to avoid danger.

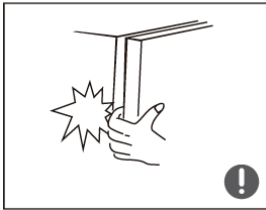

- The gaps between refrigerator doors and between doors and refrigerator body are small, be noted not to put your hand in these areas to prevent from squeezing the finger. Please be gentle when close the refrigerator door to avoid falling articles.
- Do not pick foods or containers with wet hands in the freezing chamber when the refrigerator is running, especially metal containers in order to avoid frostbite.



- Do not allow any child to get into or climb the refrigerator; otherwise suffocation or falling injury of the child may be caused.

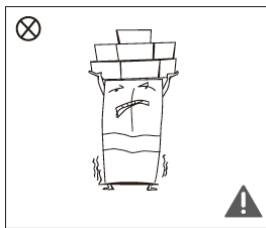

- Do not place heavy objects on the top of the refrigerator considering that objectives may fall when close or open the door, and accidental injuries might be caused.

1.5 Warnings for placement

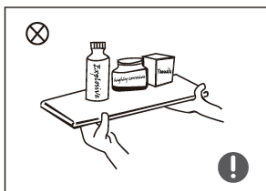

- Do not put flammable, explosive, volatile and highly corrosive items in the refrigerator to prevent damages to the product or fire accidents.
- Do not place flammable items near the refrigerator to avoid fires.

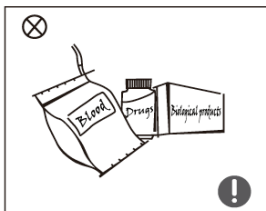

- The refrigerator is intended for household use, such as storage of foods; it shall not be used for other purposes, such as storage of blood, drugs or biological products, etc.

SAFETY WARNINGS

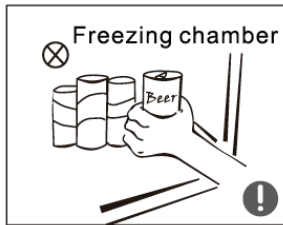

- Do not store beer, beverage or other fluid contained in bottles or enclosed containers in the freezing chamber of the refrigerator; or otherwise the bottles or enclosed containers may crack due to freezing to cause damages.

1.6 Warning for energy

Warning for energy

- 1) Refrigerating appliances might not operate consistently (possibility of defrosting of contents or temperature becoming too warm in the frozen food compartment) when sited for an extended period of time below the cold end of the range of temperatures for which the refrigerating appliance is designed.
- 2) The fact that effervescent drinks should not be stored in food freezer compartments or cabinets or in low-temperature compartments or cabinets, and that some products such as water ices should not be consumed too cold;
- 3) The need to not exceed the storage time(s) recommended by the food manufacturers for any kind of food and particularly for commercially quick-frozen food in food-freezer and frozen-food storage compartments or cabinets;
- 4) The precautions necessary to prevent an undue rise in the temperature of the frozen food while defrosting the refrigerating appliance, such as wrapping the frozen food in several layers of newspaper.
- 5) The fact that a rise in temperature of the frozen food during manual defrosting, maintenance or cleaning could shorten the storage life.

1.7 Warnings for disposal

Refrigerant and cyclopentane foaming material used for the refrigerator are flammable. Therefore, when the refrigerator is scrapped, it shall be kept away from any fire source and be recovered by a special recovering company with corresponding qualification other than be disposed by combustion, so as to prevent damage to the environment or any other harm.



When the refrigerator is scrapped, disassemble the doors, and remove gasket of door and shelves; put the doors and shelves in a proper place, so as to prevent trapping of any child.



Correct Disposal of this product:

This marking indicates that this product should not be disposed with other household wastes throughout the EU. To prevent possible harm to the environment or human health from uncontrolled waste disposal, recycle it responsibly to promote the sustainable reuse of material resources. To return your used device, please use the return and collection systems or contact the retailer where the product was purchased. They can take this product for environmental safe recycling.

PROPER USE OF REFRIGERATOR

2.1 Placement

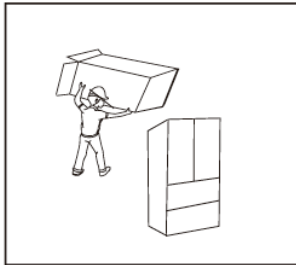

- Before use, remove all packing materials, including bottom cushions, foam pads and tapes inside of the refrigerator; tear off the protective film on the doors and the refrigerator body.

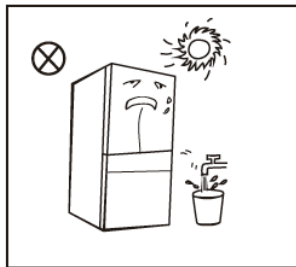

- Keep away from heat and avoid direct sunlight. Do not place the freezer in moist or watery places to prevent rust or reduction of insulating effect.
- Do not spray or wash the refrigerator; do not put the refrigerator in moist places easy to be splashed with water so as not to affect the electrical insulation properties of the refrigerator.

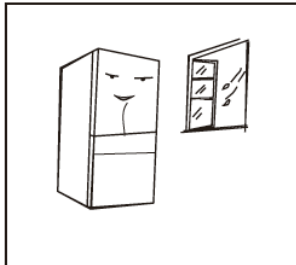

- The refrigerator is placed in a well-ventilated indoor place; the ground shall be flat, and sturdy (rotate left or right to adjust the wheel for leveling if unstable).

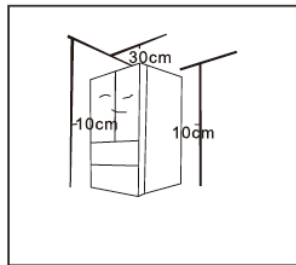

- This refrigerator needs to be installed independently and cannot be used as a built-in. Otherwise, it will cause problems such as failure to install into the cabinet, the performance and life of the product are reduced. And the manufacturer does not provide basic product warranty.
- The top space of the refrigerator shall be greater than 30cm, and the refrigerator should be placed against a wall with a free distance more than 10cm to facilitate heat dissipation.

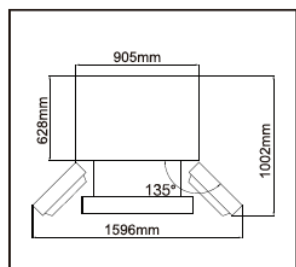

- Spare enough space for convenient opening of the doors and drawers.

The picture above is only for reference. The actual configuration will depend on the physical product or statement by the distributor.

PROPER USE OF REFRIGERATOR

2.2 Levelling feet

1) Precautions before operation

Information in the Instruction Manual is only for reference. Before operation of accessories, it shall be ensured that the refrigerator is disconnected from power. Before adjusting the leveling feet, precautions shall be taken to prevent any personal injury.

2) Schematic diagram of the levelling feet

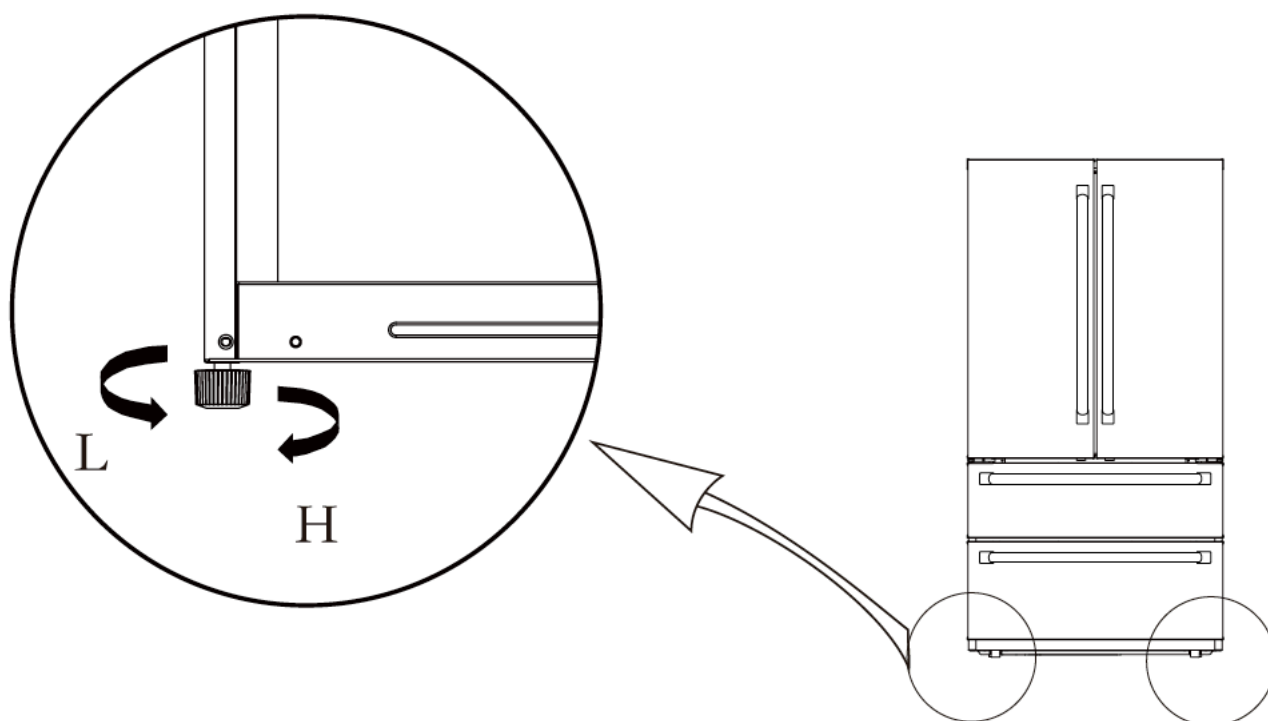

(The picture above is only for reference. The actual configuration will depend on the physical product or statement by the distributor)

3) Adjusting procedures:

- a. Turn the feet clockwise to raise the refrigerator;
- b. Turn the feet counterclockwise to lower the refrigerator;
- c. Adjust the right and left feet based on the procedures above to a horizontal level.

PROPER USE OF REFRIGERATOR

2.3 Levelling door

1) Precautions before operation:

Information in the operation is only for reference.

Before operation of accessories, it shall be ensured that the refrigerator is disconnected from power.

Before adjusting the door , precautions shall be taken to prevent any personal injury.

2) Schematic diagram of leveling the door

List of tools to be provided by the user	
	plier

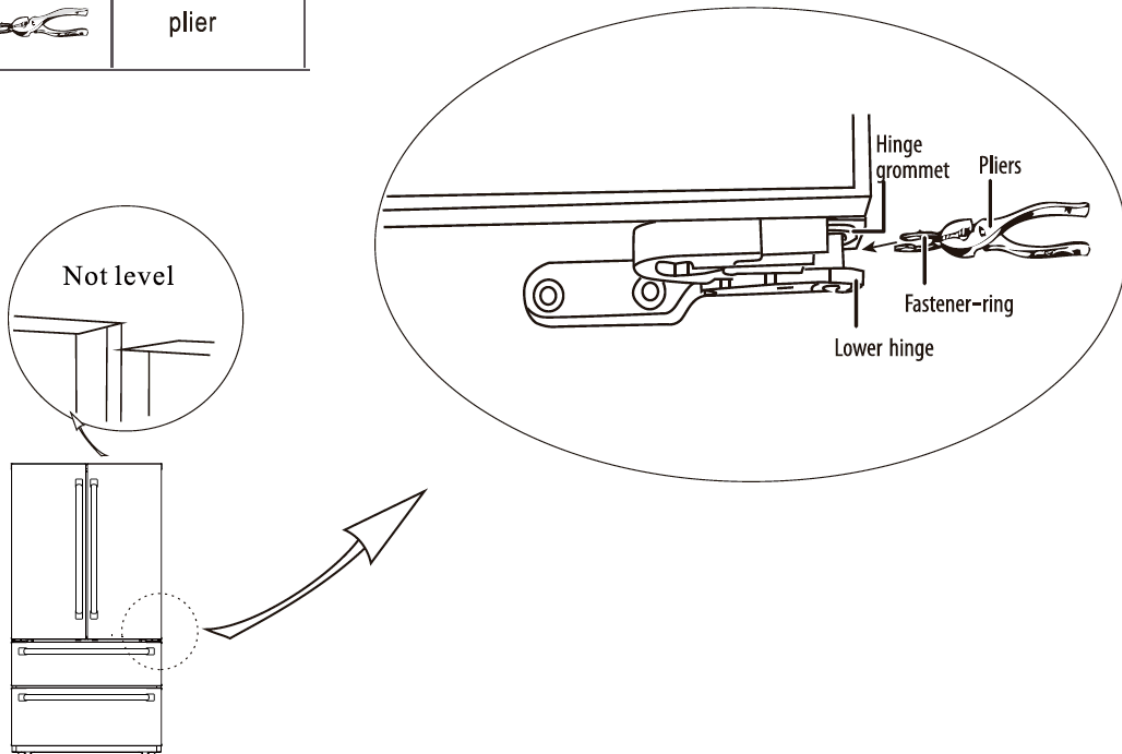

(The picture above is only for reference. The actual configuration will depend on the physical product or statement by the distributor)

1) Raise the lower door up to the level of the higher door.

2) Insert the supplied fastener-ring by using plier in the gap between the hinge-grommet and the lower hinge.

The number of fastener-rings you will need to insert depends on the gap.

PROPER USE OF REFRIGERATOR

2.4 Door handles

Assembly Instructions of Cold Storage Door Handle:

1. Take the handle set bolts out from the refrigerator, use cross recessed screwdriver to set the bolt on the door. Fix it tight with all the screw thread twisted through the hole, as shown in the figure;

2. After the first step is completed, take the Cold storage door handle out from the box, place it as per direction shown in the figure (Note: i.e. the direction which both screw holes on the handle are close to the edge), and hang the handle above the set bolt;

3. Use the small hexagon spanner supplied in the box to set the handle fixing socket head cap screws into both the small screwed holes on the handle. After they are screwed down, gently shake the handle to test if the handles are well erected.

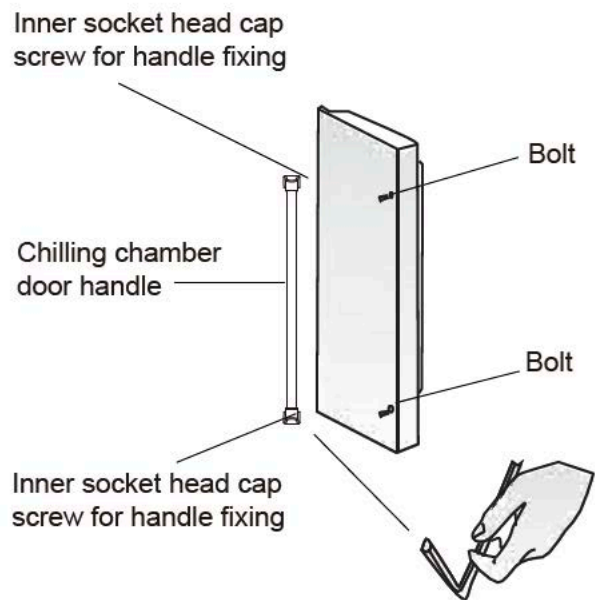

Scheme of installation of cold storage door handle

Assembly Instructions of The Refrigeration Door Handle:

The assembly steps of the refrigeration door handle are same as the cold storage door handle. Please note, the direction of tapping holds are downward to the ground when assemble the refrigerator.

PROPER USE OF REFRIGERATOR

2.5 Changing the light

Any replacement or maintenance of the LED lamps is intended to be made by the manufacturer, its service agent or similar qualified person.

2.6 Starting to use

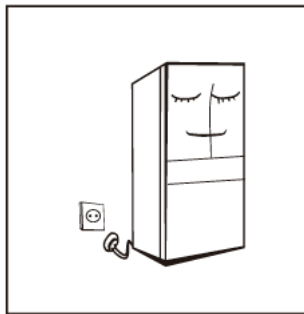

- After transportation, please let the product stay for more than 2 hours before turning on the power, otherwise it will lead to a decrease in cooling capacity or a damage to the product.
- Before putting any fresh or frozen foods, the refrigerator shall have run for 2-3 hours, or for above 4 hours in summer when the ambient temperature is high.
- Please pull out the plug in case of power failure or cleaning. Do not connect the freezer to power supply within five minutes to prevent damages to the compressor due to successive starts.

2.7 Energy saving tips

- The appliance should be located in the coolest area of the room, away from heat producing appliances or heating ducts, and out of the direct sunlight.
- Let hot foods cool to room temperature before placing in the appliance. Overloading the appliance forces the compressor to run longer. Foods that freeze too slowly may lose quality, or spoil.
- Be sure to wrap foods properly, and wipe containers dry before placing them in the appliance. This cuts down on frost build-up inside the appliance.
- Appliance storage bin should not be lined with aluminum foil, wax paper, or paper toweling. Liners interfere with cold air circulation, making the appliance less efficient.
- Organize and label food to reduce door openings and extended searches. Remove as many items as needed at one time, and close the door as soon as possible.

STRUCTURE AND FUNCTIONS

3.1 Key components

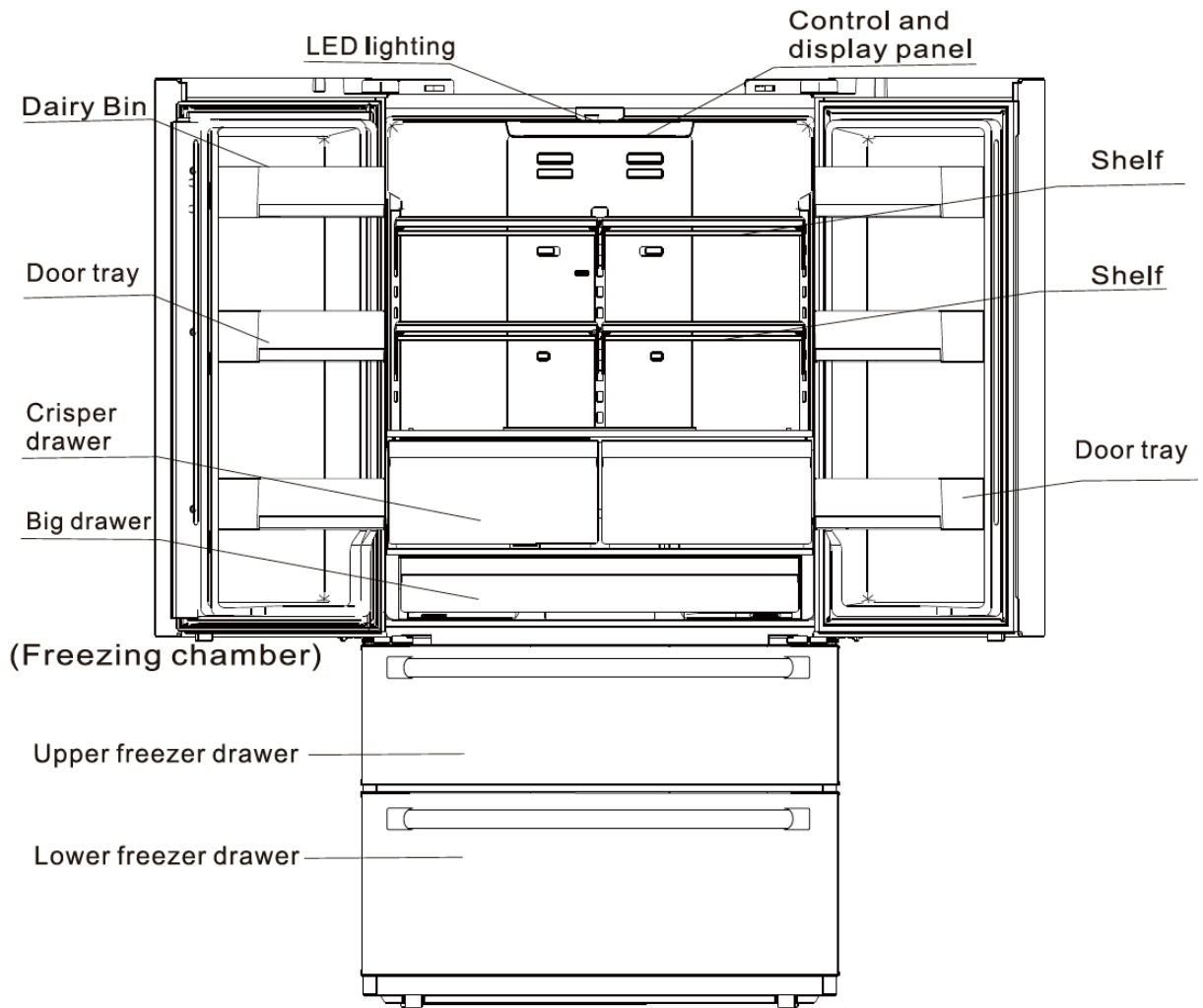

(The picture above is only for reference. The actual configuration will depend on the physical product or statement by the distributor)

STRUCTURE AND FUNCTIONS

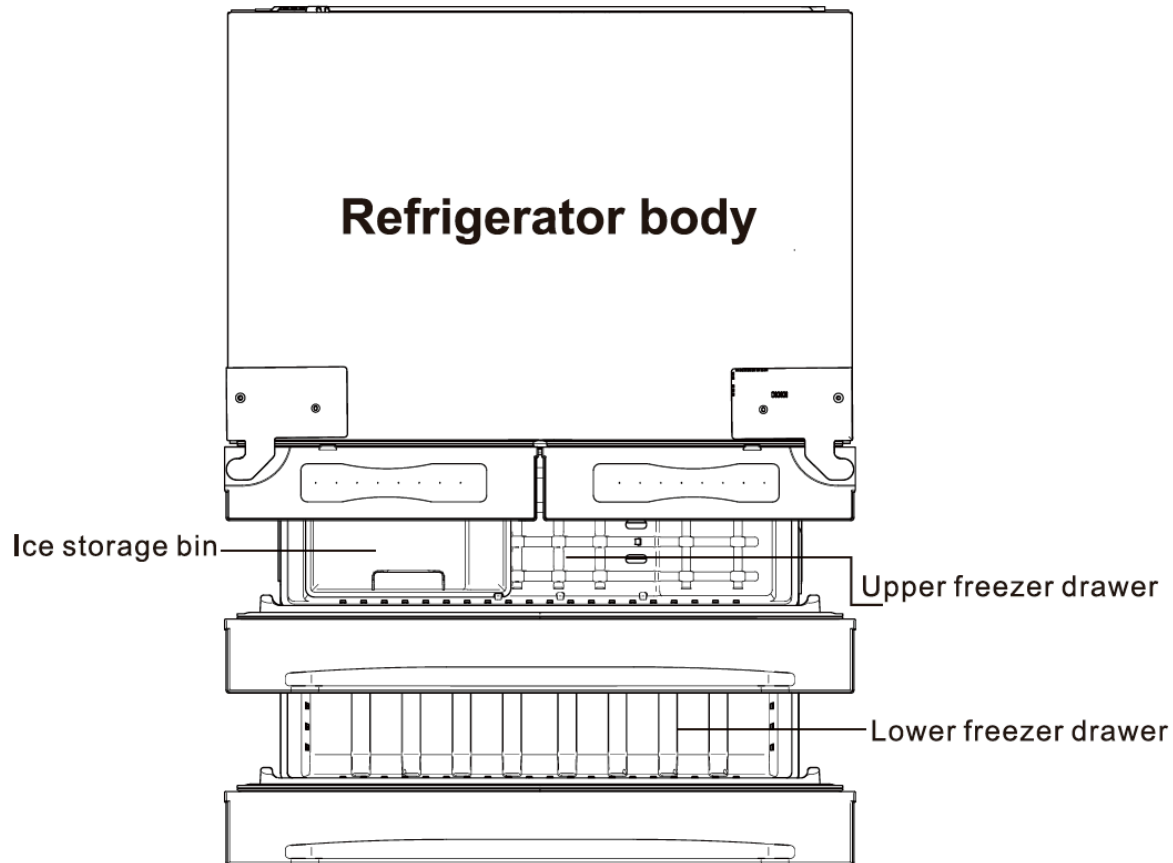

(The picture above is only for reference. The actual configuration will depend on the physical product or statement by the distributor)

Refrigerating chamber

- The Refrigerating Chamber is suitable for storage of a variety of fruits, vegetables, beverages and other food consumed in the short term.
- Cooking foods shall not be put in the refrigerating chamber until cooled to room temperature.
- Foods are recommended to be sealed up before putting into the refrigerator.
- The glass shelves can be adjusted up or down for a reasonable amount of storage space and easy use.

Freezing chamber

- The low temperature freezing chamber may keep food fresh for a long time and it is mainly used to store frozen foods and making ice.
- The freezing chamber is suitable for storage of meat, fish, rice balls and other foods not to be consumed in short term.
- Chunks of meat are preferably to be divided into small pieces for easy access. Please be noted food shall be consumed within the shelf time.

Note: Storage of too much food during operation after the initial connection to power may adversely affect the freezing effect of the refrigerator. Foods stored shall not block the air outlet; or otherwise the freezing effect will also be adversely affected.

STRUCTURE AND FUNCTIONS

3.2 Functions



(The picture above is only for reference. The actual configuration will depend on the physical product or statement by the distributor)

1. Buttons

- ① Ice-making button
- ② Super cool button
- ③ Temperature adjusting button of refrigerator room
- ④ Temperature adjusting button of freezer room
- ⑤ Super freeze button
- ⑥ Lock/unlock button

2. Display

a) When electrify the refrigerator, the display screen will totally display for 3 seconds, meanwhile the starting up bell rings, then the display screen enters the normal display of operation. (if power-on for first time, the default set temperature of the refrigerator room and the freezer room is 41°F / 0°F).

b) It will display the set temperature of both refrigerator and freezer rooms when there is no fault.

c) Under normal circumstances, the display light will go out after 30 seconds in lock state, button operation on display panel would wake up the display screen; if the opening door action wakes up the display screen, the display light would go out immediately when the door is closed; when the "fault code visible" type of fault occurs, the display screen lights up, and will go out after 30 seconds.

3. Lock/Unlock

a) In the unlock state, press and hold the lock/unlock button for 3 seconds to enter the lock state, and the buzzer sound rings.

b) In the lock state, press and hold the lock button for 3 seconds to enter the unlock state and the buzzer sound rings.

c) It will enter the lock state if there is no opening door action or any buttons operation within 30 seconds.

d) The alarm sound can be stopped by pressing any one button in lock state, but all other button operations need to be performed in unlock state. If you operate in the lock state, an error beep will be given.

4. Refrigerator temperature setting

Click the temperature adjusting button of refrigerator room to change the set temperature of refrigerator room, Each time click the button, the set temperature will drop 1°F. when the set temperature reaches the 34°F, click the button again, the set temperature will switch to 44°F. The temperature setting will take effect after the display panel is locked.

5. Freezer temperature setting

Click the temperature adjusting button of freezer room to change the set temperature of freezer room, Each time click the button, the set temperature will drop 1°F. when the set temperature reaches the -7°F, click the button again, the set temperature will switch to 7°F. The temperature setting will take effect after the display panel is locked.

STRUCTURE AND FUNCTIONS

6. Mode setting

1) Press the **SUPER COOL** button to start the super cool function. The refrigerator room is set at 34°F automatically, and the **SUPER COOL** icon shines. When exit the super cool mode, the set temperature of refrigerator room will go back to the set temperature before super cool mode.

2) Press the **SUPER FRZ** button to start the super freeze function. The freezer room is set at -7°F automatically, and the **SUPER FRZ** icon shines. When exit the super freeze mode, the set temperature of freezer room will go back to the set temperature before super freeze mode.

3) Press the **ICE MAKER** button, the ice-making function could be switched between on/off. When the  icon is on, it indicates that the ice-making function is activated.

7. Error code

When the following tips to appear on the display screen, it indicates a problem with the refrigerator. Although the refrigerator in the following fault case can still provide cool/freeze functions, but the user should contact maintenance personnel, ensure the normal use of refrigerator.

Error code	Error description
E1	Temperature sensor failure of refrigerator room
E2	Temperature sensor failure of freezer room
E5	Defrost sensor error of freezer room
E6	Communication error
E7	Ambient temperature sensor error
EH	Humidity sensor error
Eo	Ice maker error

Note: The quick-freezing function is designed to maintain the nutritional value of the food in the freezer. It can freeze the food in the shortest time. If a large amount of food is frozen at one time, it is recommended that the user turn on the quick-freezing function and put the food in. At this time, the freezing speed of the freezer compartment is increased, which can quickly freeze the food, effectively lock the nutrition of the food, and facilitate storage.

MAINTENANCE AND CARE OF THE REFRIGERATOR

4.1 Overall cleaning

- Dusts behind the refrigerator and on the ground shall be timely cleaned to improve the cooling effect and energy saving.
- Check the door gasket regularly to make sure there are no debris. Clean the door gasket with a soft cloth dampened with soapy water or diluted detergent.
- The interior of the refrigerator should be cleaned regularly to avoid odor.
- Please turn off the power before cleaning interior, remove all foods, drinks ,shelves, drawers, etc.
- Use a soft cloth or sponge to clean the inside of the refrigerator, with two tablespoons of baking soda and a quart of warm water. Then rinse with water and wipe clean. After cleaning, open the door and let it dry naturally before turning on the power.
- For areas that are difficult to clean in the refrigerator (such as narrow sandwiches, gaps or corners), it is recommended to wipe them regularly with a soft rag, soft brush, etc. and when necessary, combined with some auxiliary tools (such as thin sticks) to ensure no contaminants or bacterials accumulation in these areas.
- Do not use soap, detergent, scrub powder, spray cleaner, etc., as these may cause odors in the interior of the refrigerator or contaminated food.
- Clean the bottle frame, shelves and drawers with a soft cloth dampened with soapy water or diluted detergent. Dry with a soft cloth or dry naturally.
- Wipe the outer surface of the refrigerator with a soft cloth dampened with soapy water, detergent, etc., and then wipe dry.
- Do not use hard brushes, clean steel balls, wire brushes, abrasives (such as toothpastes), organic solvents (such as alcohol, acetone, banana oil, etc.), boiling water, acid or alkaline items, which may damage the fridge surface and interior. Boiling water and organic solvents such as benzene may deform or damage plastic parts.
- Do not rinse directly with water or other liquids during cleaning to avoid short circuits or affect electrical insulation after immersion.

 Please unplug the refrigerator for defrost and cleaning.



4.2 Overall cleaning

- According to the direction arrow in the figure below, use both hands to squeeze the tray, and push it upward, then you can take it out.
- After washing the tray having been taken out, you can adjust its installing height in accordance with your requirement.

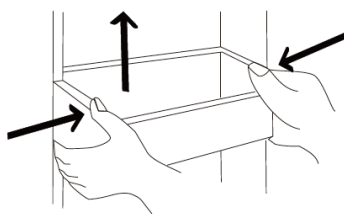

(The picture above is only for reference. The actual configuration will depend on the physical product or statement by the distributor.)

MAINTENANCE AND CARE OF THE REFRIGERATOR

4.3 Cleaning of shelf

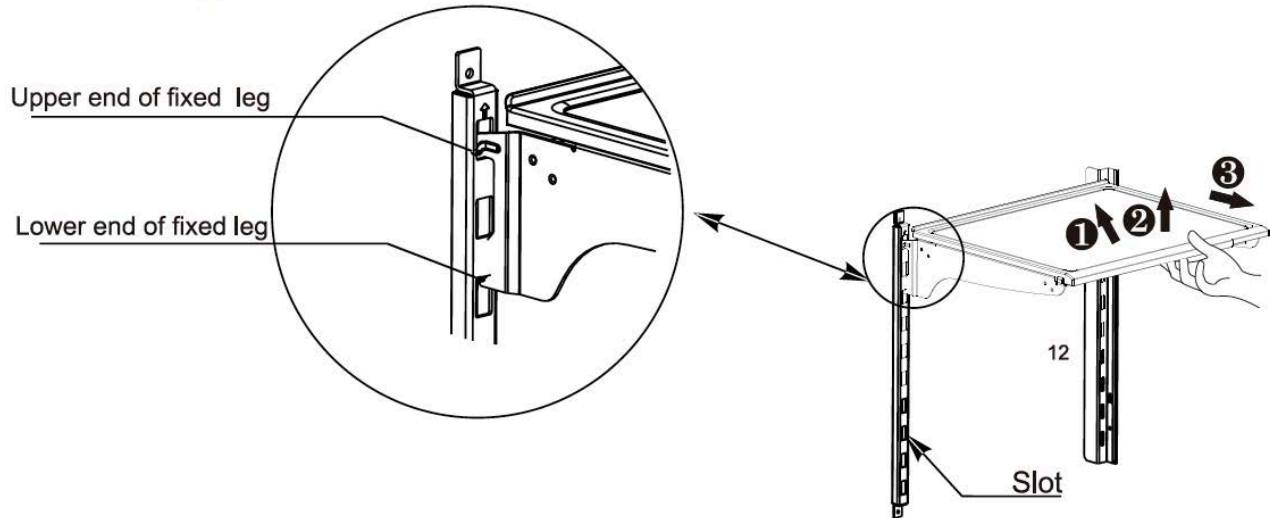

(The picture above is only for reference. The actual configuration will depend on the physical product or statement by the distributor)

- Please dismantle the cantilever shelf according to the arrows shown as above :
 - ① please hold the front edge of shelf, and tilt the shelf inwards until the lower end of fixed leg is separated from the slot of supporting iron;
 - ② uplift the whole shelf until it can not rise anymore;
 - ③ take out the shelf horizontally.
- During installation, put the upper end of the fixed leg into one of the upper slots on the supporting iron first and then put the lower end of the fixed leg into the third slot on the lower part of the supporting iron.

4.4 Cleaning of freezer lower drawer

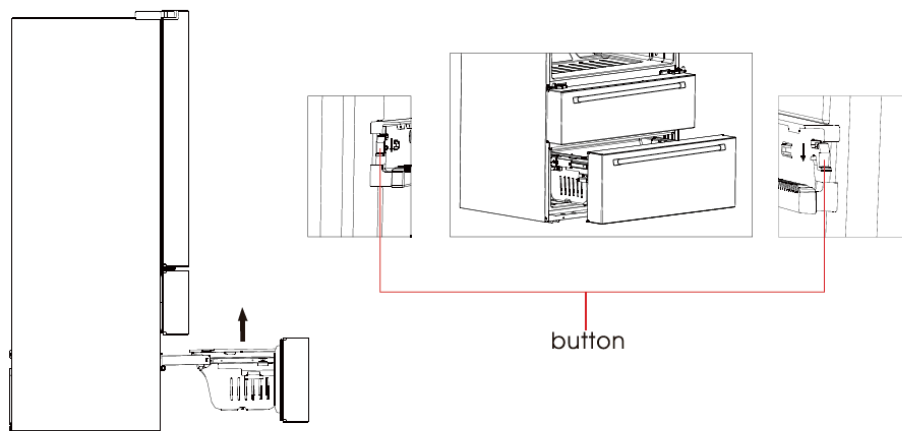

- Pull out the lower freezer drawer to the proper position.
 - As shown in the Fig., press the buttons in both slots respectively (must press both sides at the same time), pull out the freezer drawer until it stops.
 - Take out the lower drawer as directed by the arrows.
 - After cleaning, put back the drawer to original position, then close the lower drawer, the button will lock the drawer automatically.
- Note: Don't remove the lower freezer drawer if not necessary.

MAINTENANCE AND CARE OF THE REFRIGERATOR

4.5 Installing the Water Line

Installing the Water Line

Water line installation kits are available as an additional accessory from your dealer or at a local hardware store.

Connecting To The Water Supply Line

1. First, shut off the main water supply line and turn the ice-maker off.
2. Locate the nearest cold water supply valve.
3. After connecting the water supply to the water valve, turn your main water supply back on and flush several gallons of water to clear the water supply line.

The minimum inlet water pressure: 147KPa
The maximum inlet water pressure: 834KPa;

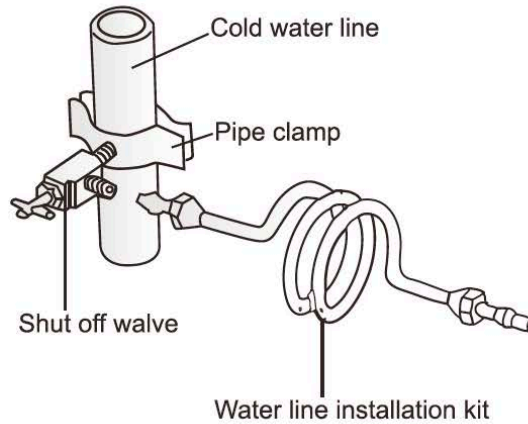

Connecting the Water Line to The Refrigerator

There are several items that you need to purchase to complete this connection.

You will find these items sold as a kit at your local hardware store.

1. First, water tubes (supplied) insert into corresponding hole of water connector (supplied).

2. Second, water line installation kit (not included) inserts into another hole of water connector (supplied).

3. Turn water valve on and check for any leakage

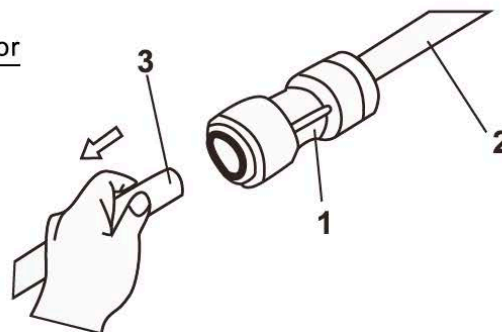

Connecting the Water Line to A Drinkable Water Source

If your water line is NOT drinkable, please add an external water filter.

If you must repair or disassemble the water line, cut off the plastic tubing to make sure you get a snug, leak-free connection.

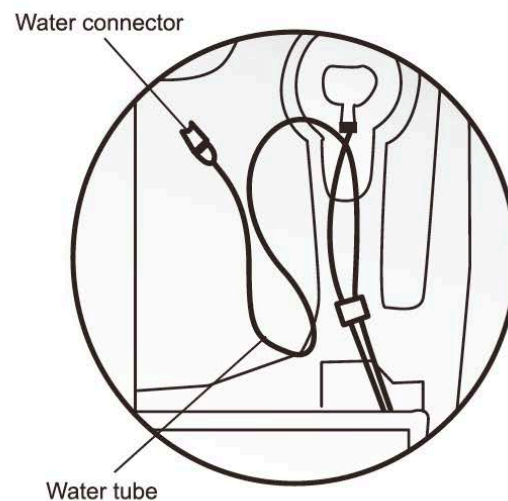

MAINTENANCE AND CARE OF THE REFRIGERATOR

4.6 Defrosting

- The refrigerator is made based on the air-cooling principle and thus has automatic defrosting function. Frost formed due to change of season or temperature may also be manually removed by disconnection of the appliance from power supply or by wiping with a dry towel.

4.7 Out of Operation

- Power failure: In case of power failure, even if it is in summer, foods inside the appliance can be kept for several hours; during the power failure, the times of door opening shall be reduced, and no more fresh food shall be put into the appliance.
- Long-time nonuse: The appliance shall be unplugged and then cleaned; then the doors are left open to prevent odor.
- Moving: Before the refrigerator is moved, take all objects inside out, fix the glass partitions, vegetable holder, freezing chamber drawers and etc. with tape, and tighten the levelling feet; close the doors and fix them with tape. During moving, the appliance shall not be laid upside down or horizontally, or be vibrated; the inclination during movement shall be no more than 45°.

 The appliance shall run continuously once it is started. Generally, the operation of the appliance shall not be interrupted; otherwise the service life may be impaired.

TROUBLESHOOTING

You may try to solve the following simple problems by yourself. If them cannot be solved, please contact the after-sales department.

Failed operation	<p>Check whether the appliance is connected to power or whether the plug is in well contact .</p> <p>Check whether the voltage is too low.</p> <p>Check whether there is a power failure or partial circuits have tripped.</p>
Odor	<p>Odorous foods shall be tightly wrapped.</p> <p>Check whether there is any rotten food.</p> <p>Clean the inside of the refrigerator.</p>
Long-time operation of the compressor	<p>Long operation of the refrigerator is normal in summer when the ambient temperature is high.</p> <p>It is not recommended having too much food in the appliance at the same time.</p> <p>Food shall get cool before being put into the appliance.</p> <p>The doors are opened too frequently.</p>
Light fails to get lit	<p>Check whether the refrigerator is connected to power supply and whether the illuminating light is damaged.</p>
Doors cannot be properly closed	<p>The door is stuck by food packages.</p> <p>The refrigerator is tilted.</p>
Loud noise	<p>Check whether the floor is level and whether the refrigerator is placed stably.</p> <p>Check whether accessories are placed at proper locations.</p>
Door seal fails to be tight	<p>Remove foreign matters on the door seal.</p> <p>Heat the door seal and then cool it for restoration (or blow it with an electrical drier or use a hot towel for heating).</p>
Water pan overflows	<p>There is too much food in the chamber or food stored contains too much water, resulting in heavy defrosting.</p> <p>The doors are not closed properly, resulting in frosting due to entry of air and increased water due to defrosting.</p>
Hot housing	<p>Heat dissipation of the built-in condenser via the housing, which is normal.</p> <p>When housing becomes hot due to high ambient temperature and storage of too much food, it is recommended to provide sound ventilation to facilitate heat dissipation.</p>
Surface condensation	<p>Condensation on the exterior surface and door seals of the refrigerator is normal when the ambient humidity is too high. Just wipe the condensate with a clean towel.</p>
Abnormal noise	<p>Buzz: The compressor may produce buzzes during operation, and the buzzes are loud particularly upon start or stop. This is normal.</p> <p>Creak: Refrigerant flowing inside of the appliance may produce creak, which is normal.</p>

WARRANTY



Warranty & Service

This product has been manufactured by Thor Group, 4651 E Airport Dr, Ontario, CA 91761

For Customer Service, please call (877) 288 - 8099

For the most up to date warranty and service policy, please refer to our website
WWW.THORKITCHEN.COM/WARRANTY-REGISTRATION

For in-warranty service requests, please visit our website at
WWW.THORKITCHEN.COM/SERVICE

Please Note: You must provide proof of purchase or installation date for any inwarranty service requests

WELCOME TO THE CLUB

You chose THOR Kitchen to enhance your culinary journey and we're stoked to have you in the club. Think of it as a secret society of really savvy people, such as yourself, choosing professional power and performance at an affordable price.



Register your product by following the steps below.

WARRANTY REGISTRATION



01

Scan the QR code or visit
thorkitchen.com/warranty



02

Input your product info
and select register



03

You're done.
Let's get cookin'.

WARRANTY



NEED PARTS?

