

# COOK LIKE A GOD

TGC3601 | TGC3001

**TGC MODELS**

**THOR**  
K I T C H E N<sup>®</sup>

**USE & CARE MANUAL**

USE AND CARE MANUAL

# PROFESSIONAL DROP-IN GAS COOKTOP

TGC MODELS

TGC3601 | TGC3001

**THOR**  
K I T C H E N<sup>®</sup>

## WARNING

**IF THE INFORMATION IN THIS MANUAL IS NOT FOLLOWED EXACTLY A FIRE OR EXPLOSION MAY RESULT CAUSING PROPERTY DAMAGE, PERSONAL INJURY OR DEATH.**

**-DO NOT** store or use gasoline or other flammable vapors and liquids in the vicinity of this or any other appliance.

### **WHAT TO DO IF YOU SMELL GAS:**

- DO NOT try to light any appliance.
- DO NOT touch any electrical switch.
- DO NOT use any phone in your building.
- Immediately call your gas supplier from a neighbor's phone. Follow the gas supplier's instructions.
- If you cannot reach your gas supplier, call the fire department.

**Installation and service must be performed by a qualified installer, service agency, or the gas supplier.**

# CONTENTS

Important safety information.....	3
Overview.....	10
Dimension and clearance.....	10
Circuit Diagram.....	12
Side & Back Panel Layout.....	13
What's included Electrical.....	14
Requirements.....	15
Using the cooktop burners.....	15
Ignition.....	15
Cookware.....	17
Install the grates.....	17
Wok Ring.....	18
Care and cleaning of the cooktop.....	18
Cooktop surface.....	18
Stainless steel surfaces.....	19
Control knobs.....	19
Burner grates and components.....	20
Burner caps and heads.....	20
Burner bases.....	21
Electrodes.....	21
Grates and wok ring.....	21
Burner head and cap replacement.....	22
Burner cap.....	23
Troubleshooting.....	24
Checkpoints.....	24
Gas Cooktop Conversion.....	25
Warranty.....	29

## IMPORTANT SAFETY INFORMATION

### READ ALL INSTRUCTIONS BEFORE USING THIS APPLIANCE

▪ All electrical and gas equipment with moving parts can be dangerous. Please read the important safety instructions for this appliance in this manual. The instructions must be followed to minimize the risk of injury, death, or property damage.

▪ Save this manual. Please Do Not Discard.

### SYMBOLS USED IN THIS MANUAL

#### **WARNING**

Hazards or unsafe practices that may result in severe personal injury or death.

#### **CAUTION**

Hazards or unsafe practices that may result in electric shock, personal injury, or property damage.

#### **NOTE**

Useful tips and instructions

These warning icons and symbols are here to prevent injury to you and others. Please follow them explicitly. After reading this section, keep it in a safe place for future reference.

### STATE OF CALIFORNIA PROPOSITION 65 WARNING (US ONLY)

#### **WARNING**

This product contains chemicals known to the State of California to cause cancer and birth defects or other reproductive harm.

Gas appliances can cause low-level exposure to Proposition 65 listed substances, including but not limited to, benzene, carbon monoxide, formaldehyde and soot, substances resulting from the incomplete combustion of natural gas or LP

fuels. For more information go to [www.P65 warnings.ca.gov](http://www.P65warnings.ca.gov)

### COMMONWEALTH OF MASSACHUSETTS

▪ This product must be installed by a licensed plumber or gas fitter qualified or licensed by the State of Massachusetts. When using ball-type gas shut-off valves, you must use the T-handle type. Multiple flexible gas lines must not be connected in series.

## GENERAL SAFETY



**To reduce the risk of fire, electric shock, personal injuries, and/or death, observe the following precautions.**

- Do not touch any part of the cooktop, including but not limited to cooktop burners during or immediately after cooking.
- Know the location of the gas shut-off valve and how to shut it off.
- Make sure the hold down brackets are properly installed on the cooktop. See the installation instructions for more information.
- Do not let children near the cooktop. Do not let children go onto the cooktop. Do not let children play with the cooktop or any part(s) of the cooktop. Do not leave children unattended in an area where the cooktop is in use.
- Remove all packaging materials from the cooktop before operating to prevent ignition of these materials. Keep all packaging materials out of children's reach. Properly dispose the packaging materials after the cooktop is unpacked.
- Do not store any object of interest to children on the cooktop or back-guard of the cooktop. Children climbing on the cooktop to reach items could be killed or seriously injured.
- Do not operate the cooktop if the cooktop or any part of the cooktop is damaged, malfunctioning, or missing parts.
- Do not use the cooktop as a space heater. Use the cooktop for cooking only. Use only dry pot holders.
- Do not use the cooktop to heat unopened food containers.
- Unplug or disconnect the power cord before servicing.
- Never store combustible materials (dishtowels, paper products, etc.) or packaged or canned food under the cooktop in a way that would let them come in contact with the underside of the cooktop. The combustible material could catch fire and the packaged or canned food could explode.
- Make sure the gas line is not compressed or bent by heavy objects. Otherwise, gas leaks or incomplete combustion may occur.



### FIRE WARNING

**To reduce the risk of fire, electric shock, personal injuries, and/or death, observe the following precautions.**

- Do not store, place, or use flammable or combustible materials such as paper, plastic, pot holders, linens, curtains, gasoline or other flammable vapors or liquids near the cooktop.
  - Do not wear loose fitting or hanging garments while using the cooktop.
  - To avoid grease buildup, regularly clean the vents.
  - Do not let pot holders or other flammable materials touch a heating element. Do not use a towel or other bulky items made out of cloth in place of a pot holder.
  - Do not use water on a grease fire. To put out a grease fire, turn off the heat source and smother the fire with a tight-fitting lid or use a multipurpose dry chemical or foam type fire extinguisher.
  - Do not heat unopened food containers. The buildup of pressure may cause the container to burst and result in injury.
- Always check if the burners are combusting normally. Overheating may cause a fire, and incomplete combustion may cause carbon-monoxide poisoning.



### GAS WARNING

**To reduce the risk of fire, electric shock, personal injuries, and/or death, observe the following precautions.**

#### Checking for gas leaks

▪ Leak testing of the appliance must be conducted according to the manufacturer's instructions. Do not use a flame to check for gas leaks. Use a brush to spread a soapy water mixture around the area you are checking. If there is a gas leak, you will see small bubbles in the soapy water mixture at the leak point.

#### If you smell gas:

- Close the valve and do not use the cooktop.
- Do not light a match, candle, or cigarette.
- Do not turn on any gas or electric appliances.
- Do not touch any electrical switches or plug a power cord into an outlet.
- Do not use any phone in your building.
- Evacuate the room, building, or area of occupants.
- Immediately call your gas supplier from a neighbor's phone. Follow the gas supplier's instructions.
- If you cannot reach your gas supplier, call the fire department.

## ELECTRICAL & GROUNDING SAFETY



### WARNING

**To reduce the risk of fire, electric shock, personal injuries, and/or death, observe the following precautions.**

- Plug the power cord into a grounded 3-prong outlet.
- Do not remove the grounding prong.
- Do not use an adapter or an extension cord.
- Do not use a damaged power plug, power cord, or loose power outlet.
- Do not modify the power plug, power cord, or power outlet in any way.
- Do not put a fuse in a neutral or ground circuit.
- Use a dedicated 120-volt, 60-Hz, 20-amp, AC, fused electrical circuit for this cooktop. A time-delay fuse or circuit breaker is recommended.
- Do not plug more than one appliance into this circuit.
- Do not connect the ground wire to plastic plumbing lines, gas lines, or hot water pipes.
- This cooktop must be Earth grounded. In the event of a malfunction or breakdown, grounding will reduce the risk of electrical shock by providing a path for the electric current. This cooktop is equipped with a cord having a grounding plug. The plug must be firmly plugged into an outlet that is properly installed and grounded in accordance with the local codes and ordinances. If you are unsure whether your electrical outlet is properly grounded, have it checked by a licensed electrician.
- The cooktop is supplied with a 3-pronged grounded plug. This cord must be plugged into a matching, grounded 3-prong outlet that meets all local codes and ordinances. If codes permit the use of a separate ground wire, we recommend that a qualified electrician determine the proper path for this ground wire.
- Electrical service to the cooktop must conform to local codes. Barring local codes, it should meet the latest ANSI/NFPA No. 70 – Latest Revision (for the U.S.) or the Canadian Electrical Code CSA C22.1 – Latest Revisions.
- It is the personal responsibility of the cooktop owner to provide the correct electrical service for this cooktop.



## INSTALLATION SAFETY



**To reduce the risk of fire, electric shock, personal injuries, and/or death, observe the following precautions.**

- Have your cooktop installed and properly grounded by a qualified installer, in accordance with the installation instructions. Any adjustment and service should be performed only by qualified gas cooktop installers or service technicians.
- Do not attempt to service, modify, or replace your cooktop or any part of your cooktop unless it is specifically recommended in this manual. All other service should be referred to a qualified technician.
- Always use new flexible connectors when installing a gas appliance. Do not use old flexible connectors.
- Make sure the hold down brackets are properly installed on the cooktop. See the installation instructions for more information.
- Remove all tape and packaging materials.
- Remove all accessories from the cooktop, Grates and griddles are heavy. Use caution when handling them.
- Make sure no parts came loose during shipping.
- Make sure your cooktop is correctly installed and adjusted by a qualified service technician or installer for the type of gas (natural or LP) you will use. For your cooktop to utilize LP gas, the installer must replace the 4 or 6 surface burner orifices with the provided LP orifice set, and reverse the GPR adapter. Further more the bypass in burner valve will need to be adjusted. These adjustments must be made by a qualified service technician in accordance with the manufacturer's instructions and all codes and requirements of the authority having jurisdiction. The qualified agency performing this work assumes the gas conversion responsibility.
- Installation of this cooktop must conform with local codes or, in the absence of local codes, with the National Fuel Gas Code, ANSI Z223.1/NFPA.54, latest edition. In Canada, installation must conform with the current Natural Gas Installation Code, CAN/CGA-B149.1, or the current Propane Installation Code, CAN/CGA-B149.2, and with local codes where applicable. This cooktop has been design-certified by ETL according to ANSI Z21.1, latest edition, and Canadian Gas Association according to CAN/CGA-1.1, latest edition.
- Make sure the middle valve has adequate capacity and is not clogged.
- This cooktop must be installed by a qualified technician. Otherwise, gas leaks, fire, or defective ignition may occur.

## LOCATION & COOKTOP SAFETY



### WARNING

**To reduce the risk of fire, electric shock, personal injuries, and/or death, observe the following precautions.**

- This cooktop is for indoor, household use only. Do not install the cooktop in areas exposed to the weather and/or water.
- Do not install the cooktop in a place which is exposed to a strong draft.
- Select a location where a grounded, 3-prong outlet is easily accessible.
- If the cooktop is located near a window, do not hang long curtains or paper blinds on that window.
- For the cooktop to ventilate properly, there must be enough clearance at the top, back and sides of the cooktop, and underneath the cooktop. The vents allow the necessary exhaust for the cooktop to operate properly with correct combustion.
- Make sure the wall coverings around the cooktop can withstand heat up to 194 °F (90 °C).
- Cabinet storage above the surface of the cooktop should be avoided. If cabinet storage above the cooktop is necessary: allow a minimum clearance of 30 inches (76.2 cm) between the cooking surface and the bottom of the cabinets.



### WARNING

**To reduce the risk of fire, electric shock, personal injuries, and/or death, observe the following precautions.**

- Select cookware that is designed for range top cooking. Use cookware that is large enough to cover the burner grates. Adjust the burner flames so that the flames do not extend beyond the bottom of the cookware.
- Make sure all burners are off when not in use.
- Do not use aluminium foil to line the grates or any part of the cooktop.
- Do not leave burners unattended on medium or high heat settings.
- Before igniting, make sure all burner caps are properly in place and all burners are level.
- Always use the LITE position when igniting the burners and make sure the burners have ignited. If ignition fails, turn the knob to OFF and wait until the gas has dissipated.
- When you set a burner to simmer, do not turn the knob quickly. Make sure the flame stays on.
- Do not place any objects other than cookware on the cooktop.
- This cooktop is designed to cook with a wok or wok ring attachment. If foods are flamed, they should only be flamed under a ventilation hood that is on.

## GENERAL SAFETY

- Before removing or changing cookware, turn off the burners.
- Remove food and cookware immediately after cooking.
- Before removing any parts of the burner for cleaning, make sure the cooktop is off and completely cool.
- After cleaning the burner spreader, make sure it is completely dry before re-assembling.
- To avoid carbon monoxide poisoning, do not pour water into the cooktop well while cleaning.
- To avoid cookware discoloration, deformity, and/or carbon monoxide poisoning, do not use cookware that is substantially larger than the grate.
- Make sure cookware handles are turned to the side or rear of the cooktop and not over other surface burners.
- Stand away from the cooktop while frying.
- Always heat frying oils slowly, and watch as they heat. If you are frying foods at high heat, carefully watch during the cooking process. If a combination of fats or oils is to be used during frying, mix them together before heating.
- Use a deep-fryer thermometer whenever possible. This prevents overheating the fryer beyond the smoking point.
- Use a minimum amount of oil when shallow pan-frying or deep-frying. Avoid cooking unthawed food or food with excessive amounts of ice.
- Before moving cookware full of fats or oils, make sure it has completely cooled.
- To prevent delayed eruptive boiling, always allow heated liquids to stand at least 20 seconds after you have turned off the burner so that the temperature in the liquid can stabilize. In the event of scalding, follow these first aid instructions:
  1. Immerse the scalded area in cool or lukewarm water for at least 10 minutes.
  2. Do not apply any creams, oils, or lotions.
  3. Cover with a clean, dry cloth.
- If a power failure occurs or the electric ignition fails to operate, do not use matches or lighters to ignite the burners. This may cause a fire or physical burns.
- Do not place and use electric-powered cooking devices such as IH rice cookers or desktop cooking heaters on top of your cooktop. Electromagnetic forces from these appliances may cause the cooktop to malfunction.

# OVERVIEW

## DIMENSION & CLEARNCE

30" /36" Model:TGC3001/TGC3601

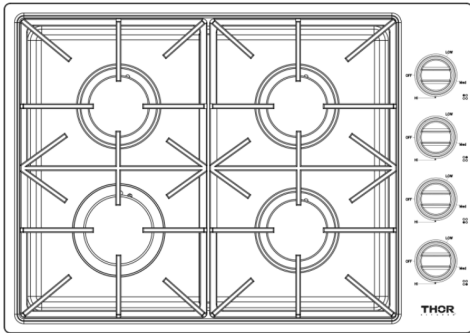

**TGC3001**

- Left Front NG/LP : 18000 BTU/H
- Left Rear NG/LP : 12000 BTU/H
- Right Front NG/LP : 9000 BTU/H
- Right Rear NG/LP : 9000 BTU/H

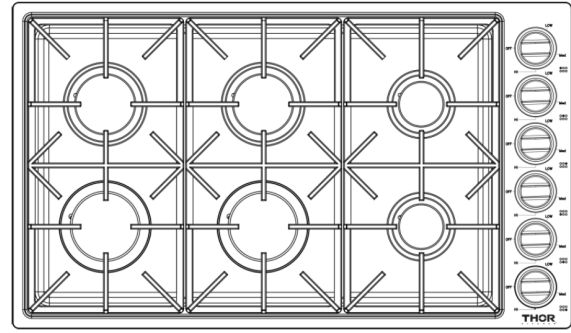

**TGC3601**

- Center Front NG/LP : 18000 BTU/H
- Center Rear NG/LP : 12000 BTU/H
- Left Front NG/LP : 18000 BTU/H
- Left Rear NG/LP : 12000 BTU/H
- Right Front NG/LP : 6000 BTU/H
- Right Rear NG/LP : 6000 BTU/H

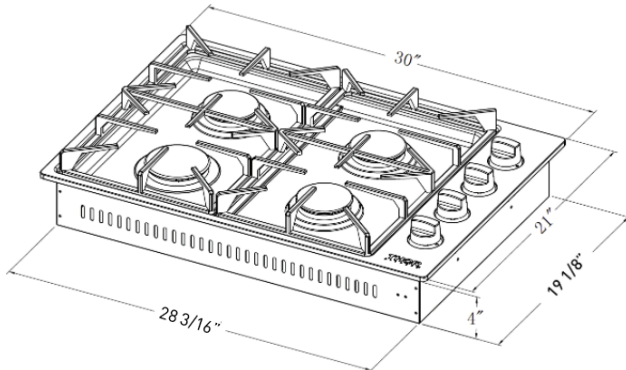

**TGC3001 Cut Out Dimension**

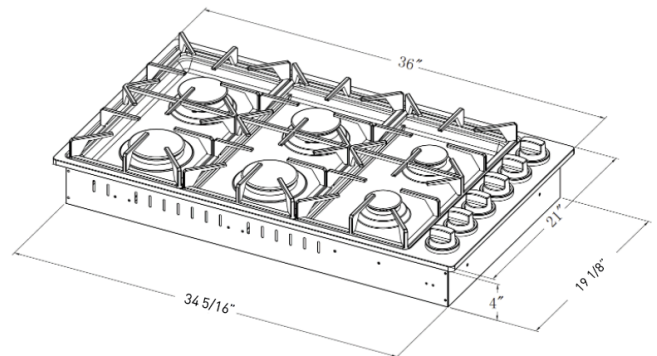

**TGC3601: Cut Out Dimension**

# OVERVIEW

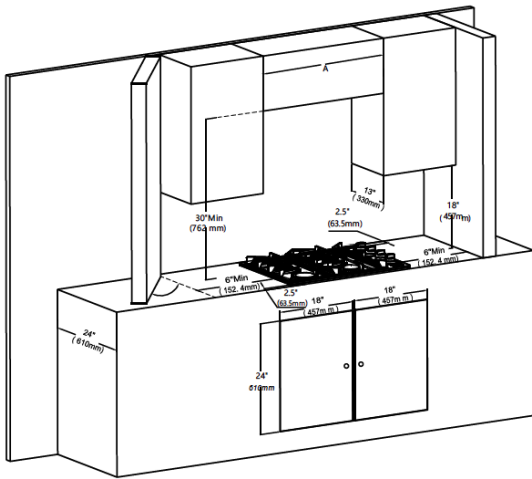

TGC3001&TGC3601 Gas Cooktop Clearance

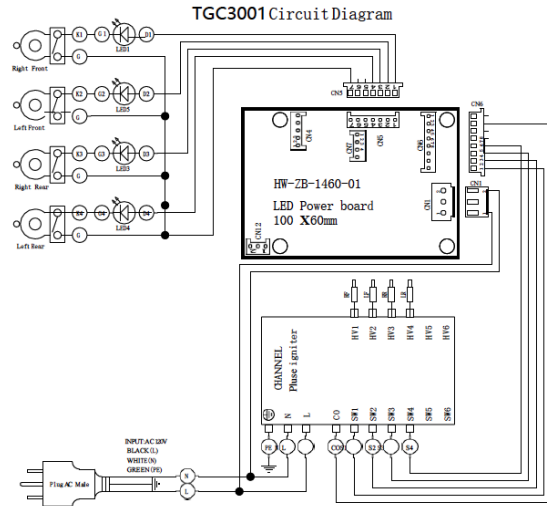

Circuit Diagram

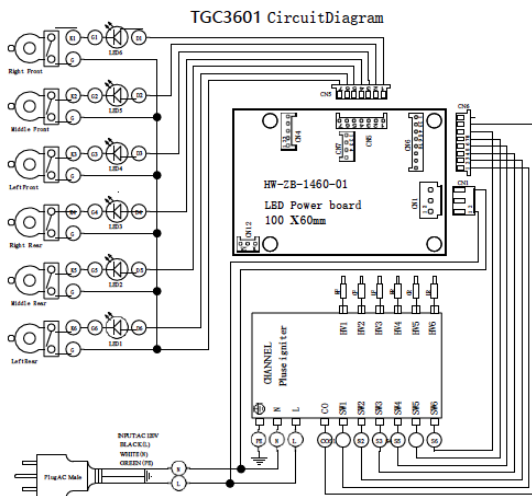

TGC3001&TGC3601 Side & Back Panel Layout

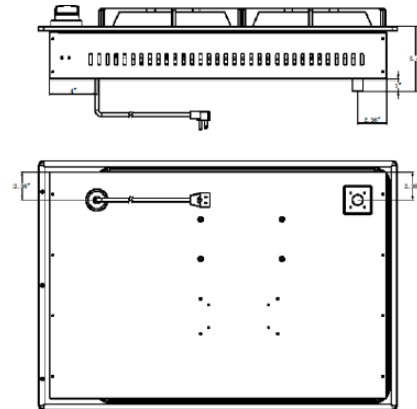

Each burner has a corresponding knob that lets you to set the flame level from LO to HI. In addition, each burner knob has a Lite setting. Turning a knob to Lite ignites the corresponding burner. The burner indicators are located above each knob and show which burner the knob controls. Each burner is designed for specific cooking purposes A statement of the maximum gas(NG10in w.c/LP 14in w.c) supply pressure in accordance with the inlet pressure rating of the gas appliance pressure regulator supplied.

# OVERVIEW

## WHATS INCLUDED

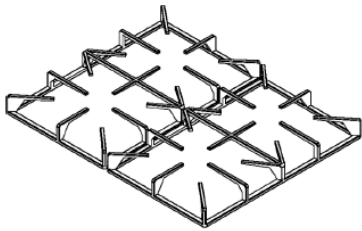

**TGC3001 Surface burner grates (2)**

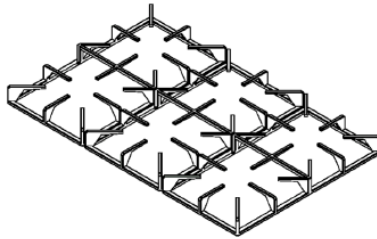

**TGC3601 Surface burner grates (3)**

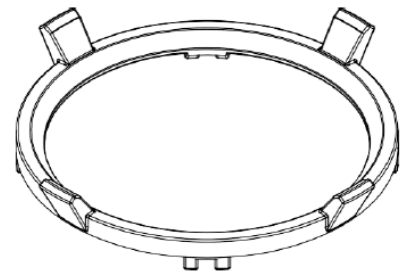

**TGC3001&TGC3601 Wok ring (1)**

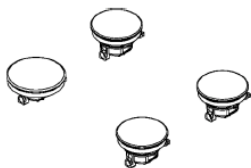

**TGC3001 Surface burners and caps (4)**

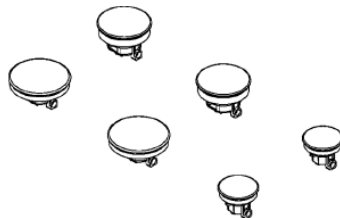

**TGC3601 Surface burners and caps (6)**

## ELECTRICAL REQUIREMENTS

Thor Kitchen Gas cooktop requires 110 volts, 50/60 Hz electrical supply to operate the ignition system.



**Electrical Grounding Instructions** This appliance is equipped with a (three-prong)(four-prong) grounding plug for your protection against shock hazard and should be plugged directly into a properly grounded receptacle. Do not cut or remove the grounding prong from this plug.

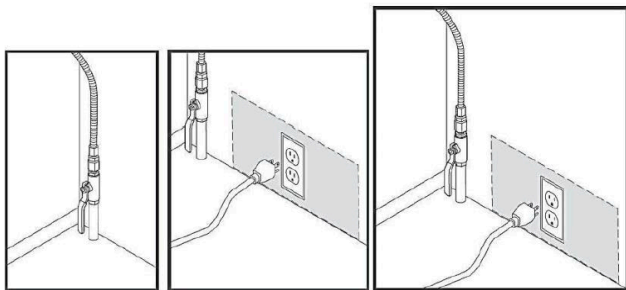

Using the cooktop burners

## IGNITION

The knob LED indicates if a burner knob has been turned on. It does not indicate if the burner flame is on. Check for an actual flame, whether the knob LED is on or off. Make sure all cooktop burners are properly installed. A statement of the gas supply pressure for checking the regulator setting [The pressure stated shall be at least NG 5in w.c./LP 10in w.c. above the manufacturer's specified manifold pressure..]

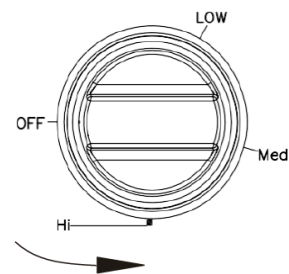

## TO LIGHT A BURNER

1. Your cooktop equip with an automatic ignition system and then turn anticlockwise to the ignite position, push in the control knob, the knob LED turns on and you will hear a “clicking” sound indicating the electronic ignition system is working properly.
2. After the cooktop burner lights, turn the control knob to shift it out of the Lite position and turn off the electronic ignition system.
3. Turn the control knob to adjust the flame Level.

## MANUAL IGNITION

If there is a power failure, you can ignite the burner manually. Use caution when doing this.

1. Hold a long gas grill lighter to the cooktop burner you want to light.
2. Push in the control knob for that burner, and then turn it to the Lite position. Turn on the grill lighter to ignite the burner.
3. After the burner is lit, turn the control knob to adjust the flame level.

## FLAME LEVEL

The flames on the burners should always stay under the cookware, and should not extend beyond the cookware bottom at any time.

## WARNING

NEVER use this appliance as a space heater to heat or warm the room. Doing so may result in carbon monoxide poisoning and overheating of the oven.

## WARNING

- Flames larger than the cookware bottom may result in a fire or physical injury.
- After turning on a surface burner, make sure that the burner has ignited even if the knob LED is on. Adjust the level of the flame by turning the burner knob.
- Always turn off the surface burner controls before removing cookware. All surface burner controls should be turned OFF when you are not cooking.
- Always turn the burners off before you go to sleep or go out.
- If you smell gas, turn off the gas to the cooktop and call a qualified wservice technician. NEVER use an open flame to locate a leak.
- If the LED on the control knob doesn't go on when the surface burner has ignited, please call Thorkitchen customer service.
- If the knob LED illuminates, but the surface burner does not ignite, turn off the control knob immediately.
- Do not operate the burner for an extended period of time without cookware on the grate. The finish on the grate may chip without cookware to absorb the heat.
- Be sure the burners and grates are cool before you place your hand, a pot holder, cleaning cloths or other materials on them.



## Requirements

- Flat bottom and straight sides
- Tight-fitting lid
- Well-balanced with the handle weighing less than the main portion of the pot or pan.

## Size limitations

## CAUTION

- Do not place a pan or pot with a bottom diameter of about 10 inches or more on the Left Front or Right Front burner.
- Always make sure cookware handles are turned to the side or rear of the cooktop and not over other surface burners. This will minimize the chance of burns, spillovers, and the ignition of flammable materials that can occur if pots or pans are bumped accidentally.
- If using glass cookware, make sure it is designed for cooktop cooking.
- Never leave plastic items on the cooktop. They can melt or ignite. Heating a sealed plastic container can cause a building up of dangerous pressure which can cause the container to explode.
- When use a wok ,make sure you hold the handle of a wok or a small one-handled pot while cooking.

## Install the grates

Install the grates as instructed below for longest life. When installed properly, the openings in the grates are centered over the burners. The three cooktop grates are designed to fit in specific positions on the cooktop. For maximum stability, these grates should only be used in their proper positions. The back of the right grate is notched to help you orient the grates correctly. See the illustration below.

### To replace the grates correctly, follow these steps:

1. Locate the notch on the back of the right grate.
2. Orient the right grate so that it is on the right side of the cooktop with the notch in the back.
3. Gently lower the legs of the right grate into the corresponding dimples on the cooktop.
4. Gently lower the legs of the remaining two grates into the corresponding dimples on the cooktop as shown in the illustration

## COOKWARE

### WOK RING

Woks are often used for stir frying, pan frying, deep frying, and poaching. The provided wok ring supports 12" to 14" woks

1. Turn off all burners, and wait until the grates completely cool down.
2. Place the wok ring on any grate.
3. Put a wok on the wok ring. Make sure the wok settles well.
4. Turn on the burner, and adjust the flame level as appropriate.

### CAUTION

- Do not remove the wok ring until the cooktop grates, surfaces, and wok grate completely cool down.
- When you use the wok with the cooktop or when the oven is on, the wok ring on the cooktop may become very hot. Use oven gloves when placing or removing the wok ring.
- Do not use pans with a flat bottom or woks with a diameter less than the wok ring diameter. The pan or wok may tip over.
- Do not use an oversized pan. The burner flames may spread out, causing damage nearby.
- This cooktop is not designed to flame foods. If foods are flamed, they should only be flamed under a ventilation hood that is on.

#### Care and cleaning of the cooktop

### WARNING

Be sure electrical power is off and all surfaces are cool before cleaning any part of the cooktop.

#### Cooktop surface

We recommend that you remove food spills immediately after they take place.

1. Turn off all surface burners.
2. Wait until all burner grates cool down, and then remove them.
3. Clean the cooktop surface using a soft cloth. If food spills run into gaps of the burner components, remove the burner cap and the head, and wipe up the spills.
4. When you are done cleaning, reinsert the burner components, and then put the burner grates back into position.

## STAINLESS STEEL SURFACES

1. Do not remove any spills, spots, and grease stains using a soft, wet cloth until surface is cool.
2. Apply an approved stainless steel cleanser to a cloth or paper towel.
3. Clean one small area at a time, rubbing with the grain of the stainless steel if applicable.
4. when done, dry the surface using a soft, dry cloth.
5. Repeat steps 2 through 4 as many times as necessary.

### CAUTION

- Do not use a steel-wool pad or abrasive cleaner, which can scratch or damage the surface.
- Do not remove the cooktop surface to clean it. The gas lines leading to the burner manifolds can be damaged, resulting in a fire or system failure.
- Do not pour water into the cooktop well while cleaning the cooktop. This could leak down into the cooktop gas and electrical systems creating a risk of electrical shock or high levels of Carbon Monoxide due to corrosion of the gas valves or ports.
- Do not spray any type of cleanser into the manifold holes. The ignition system is located in those holes and must be kept free of moisture.

### Control knobs

Make sure all surface burner knobs are in OFF position.

1. Grasp each knob and pull straight up to remove
2. Clean the knobs with soft cloth and warm, soapy water. Then rinse and dry them thoroughly.
3. Clean the stainless steel surfaces using stainless steel cleaner.
4. Re-attach the knobs in the OFF position to the control valve stems.
5. Do not remove spill protector.

Do not clean the control knobs in a dishwasher. Do not spray cleansers directly onto the control panel. Moisture entering the electric circuits may cause electric shock or product damage.

1. Grasp each knob and pull straight up to remove.
2. Spill protector. Do not remove

## BURNER GRATES AND COMPONENTS

**Turn off all surface burners and make sure they have all cooled down.**

1. Remove the burner grates.
2. Remove the burner caps from the burner heads.
3. Remove the burner heads from the valve manifolds to reveal the starter electrodes.
4. Clean all removable grates and burner components in warm, soapy water. Do not use steel-wool pads or abrasive cleaners.
5. Rinse and dry grates and burner components thoroughly.
6. Return the burner heads to their positions on top of the manifold valves. Make sure a starter electrode is inserted through the hole in each burner head burner component re-assembly instructions.
7. Return the burner caps to their positions on top of the burner heads. To ensure proper and safe operation, make sure the burner caps lie flat on top of the burner heads.
8. Re-install the burner grates in their respective positions.
9. Turn on each burner and check if it operates properly. After verifying that a burner operates normally, turn it off.

## BURNER CAPS AND HEADS

### NOTES

Before removing the burner caps and heads, remember their size and location. Replace them in the same location after cleaning. Wash burner caps and burner heads in hot, soapy water and rinse with clean running water. You may scour with a plastic scouring pad to remove burned-on food particles. Use a sewing needle or twist tie to unclog the small holes in the burner head, if required.

### CAUTION

- Do not wash any burner parts in a dishwasher.
- Do not use steel wool or scouring powders to clean the burners

## BURNER BASES

### CAUTION

The burner bases cannot be removed for cleaning. Make sure that no water gets into the burner bases and the brass gas orifices. Wipe clean with a damp cloth. Be careful not to scratch, deform, or damage the bases. Allow them to dry fully before using.

### ELECTRODES

Do not attempt to remove the electrode from the cooktop or burner bases. Be careful not to push in any cooktop controls while cleaning the cooktop. A slight electrical shock might result which could cause you to knock over hot cookware. Make sure that the white ceramic electrodes in the cooktop are clear of soil and dry. Clean the metal part of the electrode with a soft cloth. Do not use water to clean the igniters. Before reassembling the surface burners, push down gently on each of the white ceramic, electrodes to make sure they are pressed against the burners bases.

### GRATES AND WOK RING

Do not clean the grates or wok ring in a dishwasher. They will be damaged. Lift grates out when cool. Grates should be washed regularly and after spillovers. Wash them in hot, soapy water and rinse with clean water. When replacing the grates, be sure they are positioned securely over the burners.

### NOTE

Do not attempt to remove the electrode from the cooktop.

# BURNER HEAD AND CAP REPLACEMENT

## Round Burner head

1. Align the burner (point A) with the notch in the bottom cup.(point B)

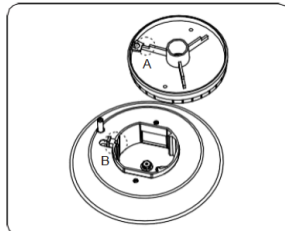

2. Turn the burner over and cover the burner cap.

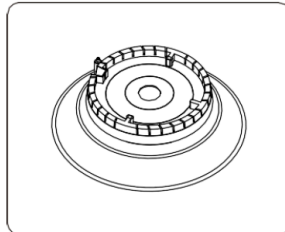

**CAUTION**  
Make sure all burner components (heads and caps) are re-installed properly. They will be stable and rest flat when correctly installed.

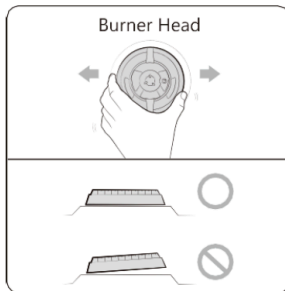

## Burner cap

1. Match the burner caps to the burners by size, and then re-install the caps on the burner heads.

**CAUTION**

Make sure each cap is re-installed on the correct burner head, is centered on the burner head, and lies flat.

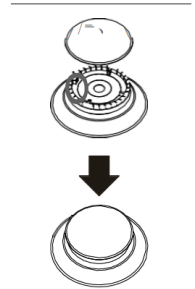

**CAUTION**

Make sure all burner components (heads and caps) are re-installed properly. They will be stable and rest flat when correctly installed

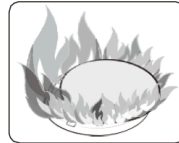
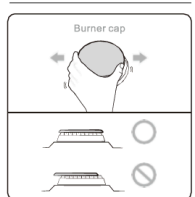

After installation of surface burners, check the ignition.

Incorrect placement of a burner head or cap will result in poor ignition or uneven flames (as shown in the pictures).

# TROUBLESHOOTING

If you encounter a problem with the cooktop, check the tables starting below, and then try the suggested actions.

## Checkpoints

### Gas safety

Problem	Possible cause	Action
You smell gas.	The surface burner knob is not in the <b>OFF</b> position and the burner is not lit.	Turn the burner knob to <b>OFF</b> .
	There is a gas leak.	Clear the room, building, or area of all occupants. Immediately call your gas supplier from a neighbor's phone. Do not call from your phone. It is electrical and could cause a spark that could ignite the gas. Follow the gas supplier's instructions. If you cannot reach your gas supplier, call the fire department.
Surface burners do not light.	The control knob is not set properly.	Push in the control knob and turn it to the Lite position.
	The burner caps are not in place. The burner base is misaligned.	Clean the electrodes. Put the burner cap on the burner head. Align the burner base.
A surface burner clicks during operation.	The control knob has been left in the Lite position.	After the burner lights, turn the control knob to a desired setting. If the burner still clicks, contact a service technician.
Very large or yellow surface burner flames.	The wrong burner orifice is installed.	Check the burner orifice size. Contact your installer if you have the wrong orifice (LP gas instead of natural gas or natural gas instead of LP gas).

# TROUBLESHOOTING

## Gas Cooktop Conversion

The cooktop is set for use with Natural Gas (NG). The factory setting is indicated on the serial plate. When set for Natural Gas (NG) operation, the pressure regulator will regulate the gas to 4" inches water column pressure. When set for Liquefied Propane Gas (LPG) operation, the pressure regulator will regulate the pressure to 11" inches water column. Please refer to Instructions for Converting cooktop to Operate on Liquefied Petroleum Gas.

## NG to LPG Conversion

### Convertible Pressure Regulator

The cooktops are shipped to operate on Natural Gas (NG). Save the NG orifices removed from the appliance for future use, make sure you note which orifices are for which burner if you plan on converting back to NG.

Instructions for Converting cooktop to Operate on Liquefied Petroleum Gas

INSTALLATION AND SERVICES MUST BE PERFORMED BY A QUALIFIED INSTALLER

**IMPORTANT: SAVE INSTRUCTION MANUAL FOR THE LOCAL INSPECTOR'S USE. READ AND SAVE THESE INSTRUCTIONS FOR FUTURE REFERENCE**

**WARNING** This conversion kit must be installed by a qualified service technician in accordance with the manufacturer's instructions and all applicable codes and requirements of the authority having jurisdiction. Failure to follow instructions may result in fire, explosion or production of carbon monoxide causing property damage, personal injury or loss of life. The qualified service agency is responsible for the proper installation of this kit. The installation is not proper and complete until the operation of the converted appliance is checked as specified in the manufacturer's instructions supplied with this kit.

**WARNING** Before proceeding with the conversion, shut off the gas supply before disconnecting electrical power to the range. Be sure power supplies are off before installing the conversion kit. Failure to do so could cause serious bodily injury.

Determine the combination of top burners that are featured on your cooktop. Identify the parts you need from this kit to complete the L.P. conversion. When burners are converted from natural to L.P. the BTU ratings are as follows: Note: For operation at elevations above 2000ft., appliance rating shall be reduced at the rate of 4% for each 1000 ft. above sea level.

TGC3001	Left Front	Left Rear	Right Front	Right Rear		
NG	1.88mm	1.50mm	1.30mm	1.30mm		
LPG	1.24mm	1.00 mm	0.90 mm	0.90mm		
TGC3601	Left Front	Left Rear	Right Front	Right Rear	Center Front	Center Rear
NG	1.88 mm	1.50 mm	1.06 mm	1.06 mm	1.88 mm	1.50 mm
LPG	1.24 mm	1.00 mm	0.70 mm	0.70mm	1.24 mm	1.00 mm



## TROUBLESHOOTING

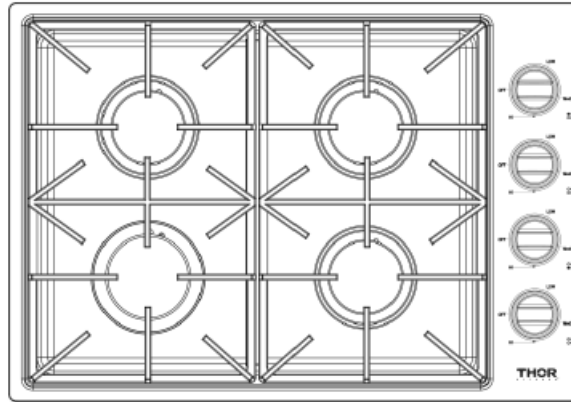

TGC3001	BURNER PERFORMANCE	
Total number of cooktop Burners	4 Burners	
Left Front	18000 BTU/H	
Left Rear	12000 BTU/H	
Right Front	9000 BTU/H	
Right Rear	9000 BTU/H	

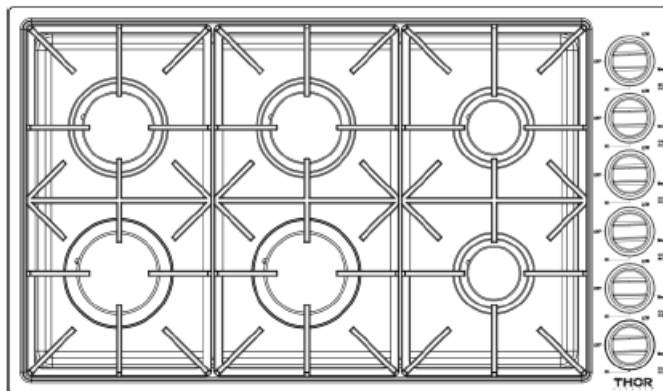

TGC3601	BURNER PERFORMANCE	
Total number of cooktop Burners	6 Burners	
Center Front	18000 BTU/H	
Center Rear	12000 BTU/H	
Left Front	18000 BTU/H	
Left Rear	12000 BTU/H	
Right Front	6000 BTU/H	
Right Rear	6000 BTU/H	

## TROUBLESHOOTING

**IMPORTANT:** After replacing the natural gas to LP orifices, be sure to keep the original factory installed natural gas orifices for future range conversion back to natural gas.

### Tools for LP Conversion

7mm Tool – Top Burner Orifice Replacement Flat Screw Driver 2.0\*130 (Not Available with the LP Conversion Kit Package) – Bypass Adjustment Adjustable Wrench \*2 (Not Available with the LP Conversion Kit Package) – Orifice Adjustment

TGC3001&TGC3601 LP Conversion

### 1.Convert the Pressure Regulator

For 30 or 36-inch Cooktop, you could find your regulator in the package box and need to be installed in the left side of the back.



**\*\*IMPORTANT\*\*** Pay attention that the NG and LP are in different direction. All the cooktop are initially designed with NG position, please have it changed in to LP position.

## TROUBLESHOOTING

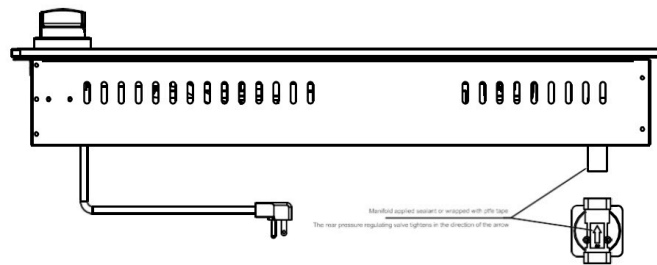

### 2. Convert Burner for LP/ Propane Gas

Save the natural gas orifices removed from the appliance for possible future conversions to natural gas. You should rely on the following process when converting unit back to Nature gas. Take extra care when handling orifice parts, making sure the orifice is not

- a. Remove top grates, burner caps and inner burner rings.
- b. Lift off outer burner heads and burner bases.
- c. Remove the factory installed natural gas orifices from the center of the orifice holders using a 7mm nut driver Remember to keep the original natural gas orifices for future conversions back to natural gas.

#### **“IMPORTANT”to identify their markings.**

- c.1. Replace the 18000BTU burner orifice in each with orifice size 1.24 mm.
- c.2 Replace the 12000BTU burner orifice in each with orifice size 1.00 mm. Please remember not to over tighten the orifice and keep the orifice clean.
- c.3 Replace the 9000BTU burner orifice in each with orifice size 0.90 mm. Please remember not to over tighten the orifice and keep the orifice clean.
- c.4 Replace the 6000BTU burner orifice in each with orifice size 0.70 mm. Please remember not to over tighten the orifice and keep the orifice clean. Put the burner flame ring back to the main burner bases. Put back the inner burner rings, burner caps and grates.

## TROUBLESHOOTING

### 3.Convert Burner Valves for LP/Propane Gas

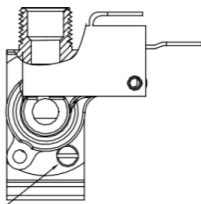
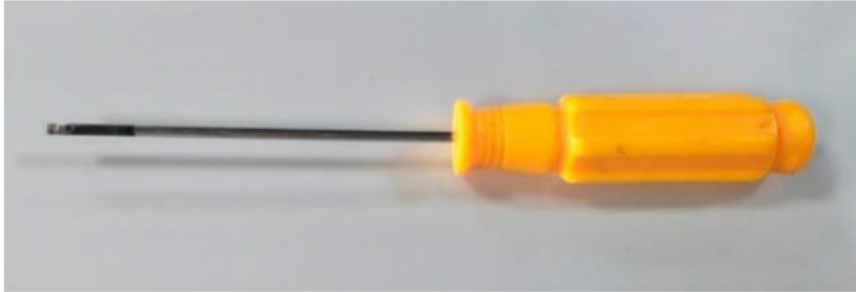

Adjust the horizontal direction of the shaft groove is NG

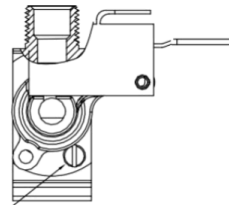

The vertical direction of the adjustment shaft groove is LP

One 5/64" flat screw driver is needed for the Bypass Adjustment on Burner Valve.

- a. Please take off the burner knobs to get access to the burner valve part. There's a hole located at bottom right of the burner valve, providing access to the adjustment of burner valve bypass orifice. Take out the bezel if needed. The hole is part of the micro-switch (the black part) sticking to the burner valve. Use the screw driver to go across the micro-switch and reach the bypass orifice on the burner valve. Bypass orifice could help to control the flame.
- b. Put the knob back, adjust the flame by rotating the knob. The original location of bypass is for NG. If converted to LP, adjust the vertical direction of the adjustment shaft groove is LP. If converted from LP to NG, adjust the horizontal direction of the shaft groove is NG.

**Originally, the Bypass is located at NG Position and it's not screwed to the bottom (tightest)**

For LP conversion of bypass, not bypass orifice needs to be changed. Screw the Bypass Orifice to bottom (clockwise). c. Save the main bypass jets, in the plastic bag labeled main jets. When you are using your top burners, if the flame needs to be adjusted accordingly to fit your need, please adjust the bypass orifices on the burner valve. Put back the knob on and adjust the flame by rotating the bypass via a small flat screw driver. Check the flame's condition to get the best performance.

## TROUBLESHOOTING

### 4.Reconnect Gas and Electrical Supply to Cooktop.

Leak testing of the appliance shall be conducted according to the installation instructions provided with the cooktop. Checking for Manifold Gas Pressure . If it is necessary to check the manifold gas pressure, remove the burner cap, inner ring, outer burner head and burner base of the right front top burner and connect a manometer (water gauge) or another pressure test device to the burner orifice. Use a rubber hose with inside diameter of approximately  $\frac{1}{4}$ " and hold the end of the tube tight over the orifice. Turn the gas valve on. For a more accurate pressure check, have at least two other top burners burning. Be sure that the gas supply (inlet) pressure is at least one inch above the specified manifold pressure. The gas supply pressure should never be over 14" water column. When properly adjusted the manifold water column pressure is 10" for LP/Propane gas or 5" for Natural Gas.

### 5.Installation of New LP / Propane Rating / Serial Plate

Record the model and serial number on the LP / Propane Rating serial plate provided in this kit. The information can be obtained from the existing Rating /Serial plate. Place the new plate as close as possible to the existing Rating /Serial plate on the range.

#### CAUTION

Do not use a flame to check for gas leaks

a.Disconnect the range and its individual shut-off valve from the gas supply piping system during any pressure of that system at test pressures greater than 14" of water column pressure (approximately  $\frac{1}{2}$ " psig)

b.The appliance must be isolated from the gas supply piping system by closing its individual manual hut-off valve during any pressure testing of the supply system at test pressure equal to or less than 14" water column pressure(approximately  $\frac{1}{2}$ " psig)

## WARRANTY

This product has been manufactured by Thor Group, 4651 E Airport Drive, California 91761

For Customer Service, please call (877) 288 - 8099

For the most up to date warranty and service policy, please refer to our website

[WWW.THORKITCHEN.COM/WARRANTY-REGISTRATION](http://WWW.THORKITCHEN.COM/WARRANTY-REGISTRATION)

For in-warranty service requests, please visit our website at

[WWW.THORKITCHEN.COM/SERVICE](http://WWW.THORKITCHEN.COM/SERVICE)

Please Note: You must provide proof of purchase or installation date for any in-warranty service requests

# WELCOME TO THE CLUB

You chose THOR Kitchen to enhance your culinary journey and we're stoked to have you in the club. Think of it as a secret society of really savvy people, such as yourself, choosing professional power and performance at an affordable price.



Register your product by following the steps below.

## WARRANTY REGISTRATION



01

Scan the QR code or visit  
[thorkitchen.com/warranty](https://thorkitchen.com/warranty)



02

Input your product info  
and select register



03

You're done.  
Let's get cookin'.

### WARRANTY



### NEED PARTS?

