

24 INCH DUAL ZONE INDOOR/OUTDOOR WINE COOLER

TWC2401D0

COOK LIKE A GOD

THOR
K I T C H E N[®]

USE & CARE MANUAL

USE AND CARE MANUAL

24 INCH DUAL ZONE INDOOR OUTDOOR WINE COOLER

TWC2401DO

THOR
K I T C H E N[®]

TABLE OF CONTENTS

Appliance Safety	3
Important Safe Guides	4
Parts and Features	5
Important Safety Instructions	6
Installation Instructions	7
- Before Using Your Appliance	7
- Installation of Your Appliance	7
- Built-in Cabinet Instructions	7
- Installing Stainless Steel Handle & Wiring Diagram	8
Operating Your Appliance	
- ON/OFF Power	
- Light Setting	9 - 10
- Temperature Setting	
- Warning System	
Care and Maintenance	
- Cleaning Your Appliance	
- Power Failure	11
- Moving Your Appliance	
- Energy Saving Tips	
- Charcoal Filtration System	
Troubleshooting Guide	12
Warranty	13

APPLIANCE SAFETY

Your safety and the safety of others are very important.

We have provided many important safety messages in this manual and on your appliance. Always read and obey all safety messages.



This is the Safety Alert Symbol. This symbol alerts you to potential hazards that can kill or injure you and others. All safety messages will follow the Safety Alert Symbol and either the words "DANGER", "WARNING" or "CAUTION".



Danger means that failure to heed this safety statement may result in severe personal injury or death.



Warning means that failure to heed this safety statement may result in extensive product damage, serious personal injury, or death.



Caution means that failure to heed this safety statement may result in minor or moderate personal injury, or property or equipment damage.

All safety messages will alert you do what the potential hazard is, tell you how to reduce the chance of injury, and let you know what can happen if the instructions are not followed.

IMPORTANT SAFE GUIDES



Before the appliance is used, it must be properly positioned and installed as described in this manual, so read the manual carefully. To reduce the risk of fire, electrical shock or injury when using the appliance, follow basic precaution, including the following:

DANGER

- Plug into a grounded 3-prong outlet, do not remove grounding prong, do not use an adapter, and do not use an extension cord.
- Replace all panels before operating.
- It is recommended that a separate circuit, serving only your appliance be provided. Use receptacles that cannot be turned off by a switch or pull chain.
- Never clean appliance parts with flammable fluids. These fumes can create a fire hazard or explosion. And do not store or use gasoline or other flammable vapors and liquids in the vicinity of this or any other appliance. The fumes can create a fire hazard or explosion.
- Before proceeding with cleaning and maintenance operations, make sure the power line of the unit is disconnected.
- Do not connect or disconnect the electric plug when your hands are wet.
- Unplug the appliance or disconnect power before cleaning or servicing. Failure to do so can result in electrical shock or death.
- Do not attempt to repair or replace any part of your appliance unless it is specifically recommended in this material. All other servicing should be referred to a qualified technician.

WARNING

FOLLOW WARNING CALL OUTS BELOW ONLY WHEN APPLICABLE TO YOUR MODEL

- Use two or more people to move and install appliance. Failure to do so can result in back or other injury.
- To ensure proper ventilation for your appliance, the front of the unit must be completely unobstructed. Choose a well-ventilated area with temperatures above 60°F (16°C) and below 90°F (32°C). This unit must be installed in an area protected from the element, such as wind, rain, water spray or drips.
- The appliance should not be located next to ovens, grills or other sources of high heat.
- The appliance must be installed with all electrical, water and drain connections in accordance with state and local codes. A standard electrical supply (115 V AC only, 60 Hz), properly grounded in accordance with the National Electrical Code and local codes and ordinances is required.
- Do not kink or pinch the power supply cord of appliance.
- The fuse (or circuit breaker) size should be 15 amperes.
- It is important for the appliance to be leveled in order to work properly. You may need to make several adjustments to level it.
- Never allow children to operate, play with or crawl inside the appliance.
- Do not use solvent-based cleaning agents or abrasives on the interior. These cleaners may damage or discolor the interior.
- Do not use this apparatus for other than its intended purpose.

PARTS & FEATURES

TWC2401DO – Indoor and Outdoor Wine Cooler

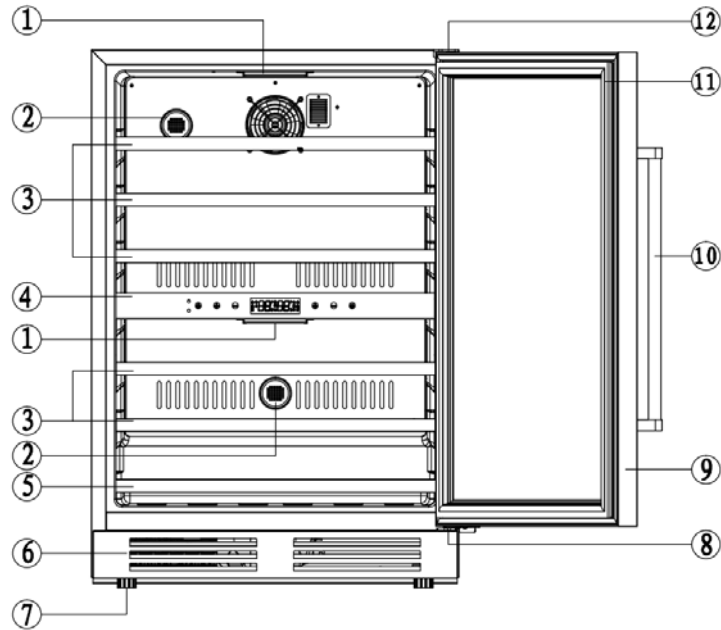

1	LED Lightings
2	Charcoal Filters
3	Wooden Shelves I
4	Digital Display & Control Panel
5	Wooden Shelves II
6	Kick Plate
7	Adjustable Feet
8	Lower Door Hinge
9	Door
10	Door Handle
11	Door Seal
12	Upper Door Hinge

IMPORTANT SAFETY INSTRUCTIONS

⚡ WARNING ⚡	To reduce the risk of fire, electrical shock, or injury when using your appliance, follow these basic precautions:
<ul style="list-style-type: none">• Read all instructions before using the appliance.• DANGER or WARNING: Risk of child entrapment. Child entrapment and suffocation are not problems of the past. Junked or abandoned appliances are still dangerous . . . even if they will “just sit in the garage a few days”.• Before you throw away your old appliance: Take off the door. Leave the shelves in place so that children may not easily climb inside.• Never allow children to operate, play with, or crawl inside the appliance.• Never clean appliance parts with flammable fluids. The fumes can create a fire hazard or explosion.• Do not store or use gasoline or any other flammable vapors and liquids in the vicinity of this or any other appliance. The fumes can create a fire hazard or explosion. <p style="text-align: center;">-Save these instructions-</p>	

➤ **ELECTRICAL CONNECTION**

⚡ Warning ⚡

Improper use of the grounded plug can result in the risk of electrical shock. If the power cord is damaged, have it replaced by a service center authorized by Thor Group.

This appliance should be properly grounded for your safety. The power cord of this appliance is equipped with a three-prong plug which mates with standard three prong wall outlets to minimize the possibility of electrical shock.

Do not under any circumstances cut or remove the third ground prong from the power cord supplied. For personal safety, this appliance must be properly grounded.

This appliance requires a standard 115/120 Volt AC ~/60Hz electrical ground outlet with three-prong. Have the wall outlet and circuit checked by a qualified electrician to make sure the outlet is properly grounded. When a standard 2-prong wall outlet is encountered, it is your responsibility and obligation to have it replaced with a properly grounded 3-prong wall outlet.

The cord should be secured behind the appliance and not left exposed or dangling to prevent accidental injury.

The appliance should always be plugged into its own individual electrical outlet which has a voltage rating that matches the rating label on the appliance. This provides the best performance and also prevent overloading house wiring circuits that could cause a fire hazard from overheated. Never unplug the appliance by pulling the power cord. Always grip the plug firmly and pull straight out from the receptacle. Repair or replace immediately all power cords that have become frayed or otherwise damaged. Do not use a cord that shows cracks or abrasion damage along its length or at either end. When moving the appliance, be careful not to damage the power cord.

➤ **EXTENSION CORD**

Because of potential safety hazards under certain conditions, it is strongly recommended that you do not use an extension cord with this appliance. However, if you must use an extension cord it is absolutely necessary that it be a UL/CUL-Listed, 3-wire grounding type appliance extension cord having a grounding type plug and outlet and that the electrical rating of the cord be 115 volts and at least 10 amperes.

INSTALLATION INSTRUCTIONS

➤ **BEFORE USING YOUR APPLIANCE**

- Remove the exterior and interior packing.
- Check to be sure you have all of the following parts:

Model TWC2401DO	
1	Instruction Manual
6	Wooden Shelves (With Rolling Slideways)
1	Door Handle

- Before connecting this appliance to the power source, let it stand upright for approximately 2 hours. This will reduce the possibility of a malfunction in the cooling system from handling during transportation.
- Clean the interior surface with lukewarm water using a soft cloth.

➤ **INSTALLATION OF YOUR APPLIANCE**

- This appliance is designed to be for free standing installation or built-in (fully recessed).
- Place your appliance on a floor that is strong enough to support it when it is fully loaded. To level your appliance, adjust the front leveling legs at the bottom of the appliance.
- Locate the appliance away from direct sunlight and sources of heat (stove, heater, radiator, etc.). Direct sunlight may affect the acrylic coating and heat sources may increase electrical consumption. Extreme cold ambient temperatures may also cause the unit not to perform properly.
- Avoid locating the unit in moist areas.
- Plug the appliance into an exclusive, properly installed-grounded wall outlet. Do not under any circumstances cut or remove the third (ground) prong from the power cord. Any questions concerning power and/or grounding should be directed toward a certified electrician or a service center authorized by Thor Group.

➤ **BUILT – IN CABINET INSTRUCTIONS**

This unit is designed for both built-in or free standing installation. If you plan to use this unit in a built-in application, please follow the requirements shown to the right.

Cabinet Opening Dimensions		
	IN (min)	CM (min)
Width	23 ⁴ / ₅ "	60.5 cm
Depth	24"	61.0 cm
Height	34 ¹ / ₂ "	87.6 cm

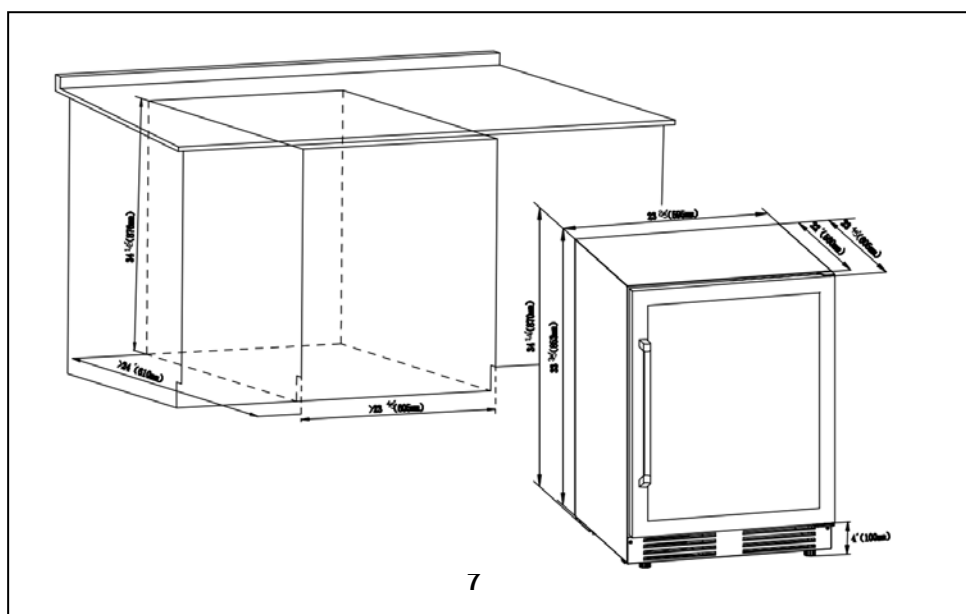

➤ **INSTALLING STAINLESS STEEL HANDLE**

This cooler includes a stainless steel handle that is not installed by the factory. To install the handle please follow the below instructions:

1. Pull away the door gasket in the area where the handle is to be installed as shown below in Illustration # 1. The gasket is easily displaced by hand, no tools are necessary.
2. Align the handle with the screws pre-installed on the backside of the door. Tighten the screws using a Phillips head screwdriver until the handle sets both flush and secured tightly against the door frame. (DO NOT overtighten as this will cause damage to the handle assembly).
3. Replace the door gasket to its original position.

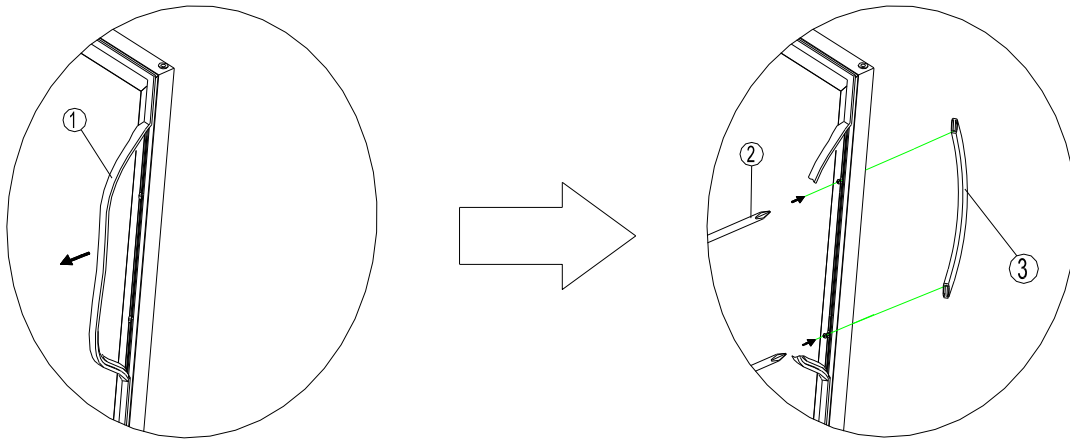

- ① Grasket
- ② Screw driver
- ③ S/S Handle

➤ **WIRING DIAGRAM**

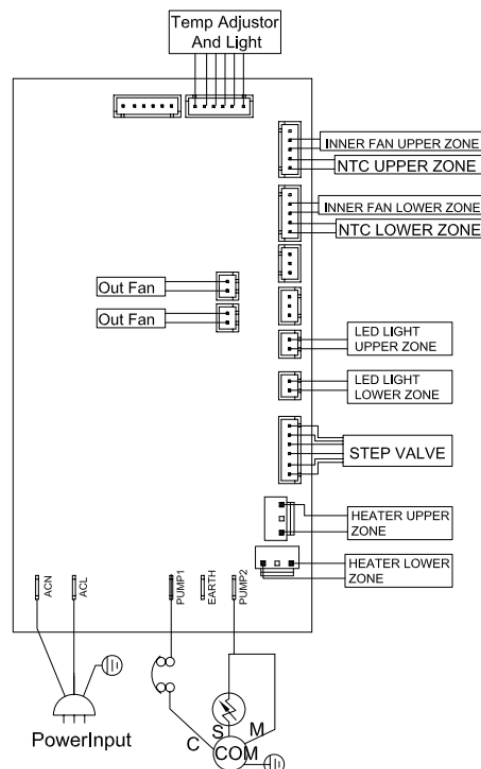

OPERATING YOUR APPLIANCE

It is recommended you install the appliance in a place where the ambient temperature is between 61° - 100° F (16°-38° C). If the ambient temperature is higher or lower than recommended temperatures, the performance of the unit may be affected. For example, placing your unit in extreme cold or hot conditions may cause interior temperatures to fluctuate, then the range of 41°-65° F (5°-18° C) may not be reached.

Temperature Ranges by Two Zones		
WINE COOLER (UPPER & LOWER ZONE)	41° - 65° F	5° - 18° C

Recommended Temperatures for Chilling Wine.

Red Wines	58 - 65 °F	15 - 18 °C
Dry / White Wines	48 - 57 °F	10 - 14 °C
Rose Wines	49 - 51 °F	9 - 11 °C
Sparkling Wines	40 - 47 °F	5 - 8 °C

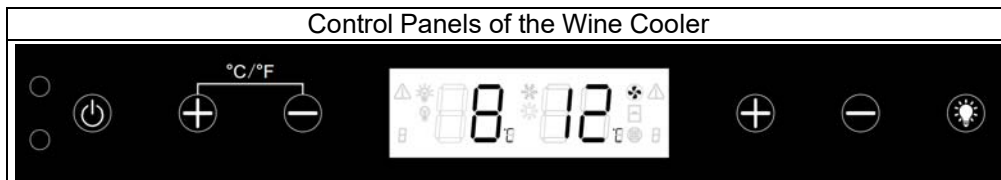



➤ **ON/OFF POWER**

- Press and hold  for 2 seconds on control panel to turn on or turn off the cooler, when cooler is turned off, the appliance will stop working and total shut down.



➤ **LIGHT SETTING**

- There are two light modes, press and hold  for 3 seconds to select a light mode.

1. Light on and off mode: The default setting of light will be controlled by sensor and LCD screen will show  , when door is opened, the light will turn on automatically, when door is closed, the light will be turned off.

2. Light on model: Press and hold  for 3 seconds to enter light on mode, when in this mode, LCD screen will display  and light will always be on.

➤ **TEMPERATURE SETTING**

- Press  or  on the left for upper zone and on the right for lower zone to adjust the temperature of the appliance and each press on the button will alter the temperature by 1° F or 1° C.

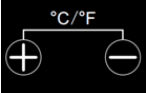
- Press  on the left together and hold for 3 seconds to change temperature display from Celsius to Fahrenheit or from Fahrenheit to Celsius.

➤ **WARNING SYSTEM**

1. Door open alarm: When door has been opened for over 5 minutes, door open alarm will be on and LCD screen display  and beep 3 times every 5 seconds, press any key or close the door to stop the alarm.

2. Low temperature alarm: When inside temperature is below 35.6° F (2° C) for over 3 hours, it will beep to alarm and LCD screen will display  **L** ; Press any key to stop the beeping alarm.

3. High temperature alarm: When inside temperature is above 77° F (25° C) for over 6 hours, it will beep to alarm and LCD screen will display  **H** ; Press any key to stop the beeping alarm.

CARE AND MAINTENANCE

➤ **CLEANING YOUR APPLIANCE**

- Turn off the power, unplug the appliance, and remove all items including shelves.
- Wash the inside surfaces with a warm water and baking soda solution. The solution should be about 2 tablespoons of baking soda to a quart of water.
- Wash the shelves with a mild detergent solution.
- Wring excess water out of the sponge or cloth when cleaning area of the controls, or any electrical parts.
- Wash the outside cabinet with warm water and mild liquid detergent. Rinse well and wipe dry with a clean soft cloth.
- Do not use steel wool or steel brush on the stainless steel. These will contaminate the stainless steel with steel particles and rusting may occur.

➤ **POWER FAILURE**

- Most power failures are corrected within a few hours and should not affect the temperature of your appliance if you minimize the number of times the door is opened. If the power is going to be off for a longer period of time, you need to take the proper steps to protect your contents.

➤ **MOVING YOUR APPLIANCE**

- Remove all items.
- Securely tape down all loose items (shelves) inside your appliance.
- Tape the door shut.
- Be sure the appliance stays secure in the upright position during transportation. Also protect outside of appliance with a blanket, or similar item.

➤ **ENERGY SAVING TIPS**

- The appliance should be located in the coolest area of the room, away from heat producing appliances, and out of the direct sunlight.

➤ **CHARCOAL FILTRATION SYSTEM**

Your wine is a living object that breathes through the cork of its bottle. In order to preserve the quality and taste of your fine wines, they must be stored at the ideal temperature and ambient conditions. Your cellar is equipped with an active charcoal filtration system to ensure air purity, cooling efficiency, and to maintain an odor free cabinet for the storage of your good wine. The filter assembly is located at the rear panel inside your cooler.

Keep in mind, that this filter must be changed every 12 months.

To replace your filter:

1	Remove the bottles / cans stored on the two shelves in front of the filter.	
2	Remove the shelves and set aside to be replaced once you have changed the filter.	
3	Hold the filter and turn it at 90 degrees in the anti-clockwise direction and then pull it out.	
4	Remove the existing filter and replace with a new one.	
5	Put the new filter into the hole and then turn the filter at degrees in clockwise direction.	

PROBLEMS WITH YOUR APPLIANCE?

You can solve many common problems easily, saving you the cost of a possible service call. Try the suggestions below to see if you can solve the problem before calling the servicer.

TROUBLESHOOTING GUIDE

PROBLEM	POSSIBLE CAUSE
Appliance does not operate.	Not plugged in. The appliance is turned off. The circuit breaker tripped or a blown fuse.
Appliance is not cold enough.	Check the temperature control setting. External environment may require a higher setting. The door is opened too often. The door is not closed completely. The door gasket does not seal properly.
Turns on and off frequently.	The room temperature is hotter than normal. A large amount of contents has been added to the unit. The door is opened too often. The door is not closed completely. The temperature control is not set correctly. The door gasket does not seal properly.
The light does not work.	Not plugged in. The circuit breaker tripped or a blown fuse. The light button is "OFF".
Vibrations.	Check to assure that the appliance is level.
The appliance seems to make too much noise.	The rattling noise may come from the flow of the refrigerant, which is normal. As each cycle ends, you may hear gurgling sounds caused by the flow of refrigerant in your appliance. Contraction and expansion of the inside walls may cause popping and crackling noises. The appliance is not level.
The door will not close properly.	The appliance is not level. The gasket is dirty. The shelves are out of position.
Display flashes Error message "E0"	Connection failure – there is a wire or component that is not connected correctly. Contact our customer service at 877-288-8099 (THORKITCHEN Wine Cooler).
Display flashes Error message "E1"	Temperature sensor failure. Contact our customer service at 877-288-8099 (THORKITCHEN Wine Cooler).
Display flashes Error message "E2"	Defrost sensor (Coil Sensor) failure. Contact our customer service at 877-288-8099 (THORKITCHEN Wine Cooler).

Warranty

This product has been manufactured by Thor Group, 4651 E Airport Drive, California 91761

For Customer Service, please call (877) 288 - 8099

For the most up to date warranty and service policy, please refer to our website

WWW.THORKITCHEN.COM/WARRANTY-REGISTRATION

For in-warranty service requests, please visit our website at

WWW.THORKITCHEN.COM/SERVICE

Please Note: You must provide proof of purchase or installation date for any in-warranty service requests

WELCOME TO THE CLUB

You chose THOR Kitchen to enhance your culinary journey and we're stoked to have you in the club. Think of it as a secret society of really savvy people, such as yourself, choosing professional power and performance at an affordable price.



Register your product by following the steps below.

WARRANTY REGISTRATION



01

Scan the QR code or visit
thorkitchen.com/warranty



02

Input your product info
and select register



03

You're done.
Let's get cookin'.



For additional information and product support, visit thorkitchen.com/service