

# TRUARCTIC

## INSTALLATION USER MANUAL

30 Inch Wall Mount Range Hood

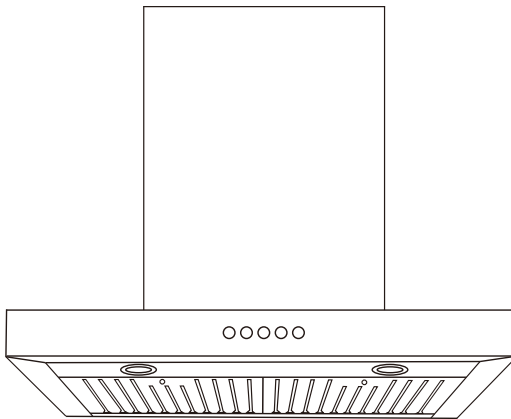

TAWM30SS



**CONTENT**

Introduction .....	2
Safety Precaution .....	2
Important Safety Information.....	3-5
Parts Diagram.....	6
Installation Instructions .....	8
Air Outlet Installation Method.....	9
Installation.....	9-11
Oil Cup Installation .....	12
Operation .....	12
Maintenance .....	13-14
Trouble-Shooting .....	15
Environmental Protection .....	15
Warranty .....	16

## Introduction

### Thank you for choosing this cooker hood.

- This instruction manual is designed to provide you with all required instructions related to the installation, use and maintenance of the appliance.
- In order to operate the unit correctly and safely, please read this instruction manual carefully before installation and usage.

## Safety Precaution

- Never let the children operate the machine.
- The cooker hood is for home use only, not suitable for barbecue, roast shop and other commercial purpose.
- Clean the cooker hood according to the instruction manual and keep the unit from danger of burning. There is a fire risk if cleaning is not carried out in accordance with the instructions.
- Please keep the kitchen room a good convection before connecting this appliance; Please check that the power supply cord is undamaged. A damaged supply cord must be replaced by qualified service personnel only.
- Regulations concerning the discharge of air have to be fulfilled.
- This appliance can be used by children aged from 8 years and above also the persons with reduced physical, sensory or mental capabilities or lack of experience and knowledge if they have been given supervision or instruction concerning use of the appliance in a safe way and understand the hazards involved. Children shall not play with the appliance. Cleaning and user maintenance shall not be made by children without supervision.
- If the supply cord is damaged, it must be replaced by the manufacturer, its service agent or similarly qualified persons in order to avoid a hazard.



### **CAUTION:**

**Accessible parts may become hot when used with cooking appliance.**

### **Electrical Shock Hazard**

Only plug this unit into a properly earthed outlet.

If you have doubts, seek advice from a suitably qualified engineer.

Installer: Leave this manual with the homeowner

## IMPORTANT SAFETY INFORMATION

# READ ALL INSTRUCTIONS BEFORE USING

### WARNING



TO REDUCE THE RISK OF FIRE, ELECTRIC SHOCK, OR INJURY TO PERSONS, OBSERVE THE FOLLOWING:



- Use this unit only in the manner intended by the manufacturer. If you have questions, contact the manufacturer at the address or telephone number listed in the warranty.



- Before servicing or cleaning unit, switch power off at service panel and lock the service disconnecting means to prevent power from being switched on accidentally. When the service disconnecting means cannot be locked, securely fasten a prominent warning device, such as a tag, to the service panel.
- Installation work and electrical wiring must be done by a qualified person(s) in accordance with all applicable codes and standards, including fire-rated construction codes and standards.
- Sufficient air is needed for proper combustion and exhausting of gases through the flue (chimney) of fuel burning equipment to prevent backdrafting. Follow the heating equipment manufacturer's guideline and safety standards such as those published by the National Fire Protection Association (NFPA), and the American Society for Heating, Refrigeration and Air Conditioning Engineers (ASHRAE), and the local code authorities.
- When cutting or drilling into wall or ceiling, do not damage electrical wiring and other hidden utilities.
- Ducted fans must always be vented to the outdoors.
- Do not use this unit with any separate solid-state speed control device.
- To reduce the risk of fire, use only metal ductwork.
- This unit must be grounded.
- When installing, servicing or cleaning the unit, it is recommended to wear safety glasses and gloves.
- When applicable local regulations comprise more restrictive installation and/or certification requirements, the aforementioned requirements prevail on those of this document and the installer agrees to conform to these at his own expense.
- Do not attempt to repair or replace any part of your hood unless it is specifically recommended in this manual. All other servicing should be referred to a qualified technician.

FOR GENERAL VENTILATING USE ONLY. DO NOT USE TO EXHAUST HAZARDOUS OR EXPLOSIVE MATERIALS AND VAPORS.

Installer: Leave this manual with the homeowner

## IMPORTANT SAFETY INFORMATION

# READ ALL INSTRUCTIONS BEFORE USING

### WARNING



TO REDUCE THE RISK OF A RANGE TOP GREASE FIRE:

- Never leave surface units unattended at high settings. Boilovers cause smoking and greasy spillovers that may ignite. Heat oils slowly on low or medium settings.
- Always turn hood ON when cooking at high heat or when flambing food (i.e. Crepes Suzette, Cherries Jubilee, Peppercorn Beef Flambé).
- Clean ventilating fans frequently. Grease should not be allowed to accumulate on fan or filter.
- Use proper pan size. Always use cookware appropriate for the size of the surface element.
- TO REDUCE THE RISK OF INJURY TO PERSONS IN THE EVENT OF A RANGE TOP GREASE FIRE, OBSERVE THE FOLLOWING:\*
- SMOTHER FLAMES with a close-fitting lid, cookie sheet, or metal tray, then turn off the burner. BE CAREFUL TO PREVENT BURNS. If the flames do not go out immediately, EVACUATE AND CALL THE FIRE DEPARTMENT.
- NEVER PICK UP A FLAMING PAN - You may be burned.
- DO NOT USE WATER, including wet dishcloths or towels - violent steam explosion will result.
- Use an extinguisher ONLY if:
- You know you have a Class ABC extinguisher and you already know how to operate it.
- The fire is small and contained in the area where it started.
- The fire department is being called.
- You can fight the fire with your back to an exit.
- Based on "Kitchen Fire Safety Tips" published by NFPA.

### CAUTION



- For indoor residential use only.
- To reduce risk of fire and to properly exhaust air, be sure to duct air outside. Do not vent exhaust air into spaces within walls or ceilings or into attics, crawl spaces, or garages.
- Take care when using cleaning agents or detergents.
- Avoid using food products that produce flames under the Range Hood.
- For general ventilating use only. Do not use to exhaust hazardous or explosive materials and vapors.
- To avoid motor bearing damage and noisy and/or unbalanced impellers, keep drywall spray, construction dust, etc. off power unit.
- Your hood motor has a thermal overload which will automatically shut off the motor if it becomes overheated. The motor will restart when it cools down. If the motor continues to shut off and restart, have the hood serviced.
- The bottom of the hood MUST NOT BE LESS than 24" and recommended at a maximum of 30" above the cooktop for best capture of cooking impurities.
- Use only with range hood cord connection kits that have been investigated and found acceptable for use with this model range hood.
- Please read specification label on product for further information and requirements.

**IMPORTANT SAFETY INFORMATION****READ ALL INSTRUCTIONS BEFORE USING**

---

**Installer: Leave this manual with the homeowner**

**How to Remove Protective Shipping Film and Packaging Tape**

Carefully grasp a corner of the protective shipping film with your fingers and slowly peel it from the appliance surface. Do not use any sharp items to remove the film. Remove all of the film before using the appliance for the first time.

To assure no damage is done to the finish of the product, the safest way to remove the adhesive from packaging tape on new appliances is an application of a household liquid dishwashing detergent. Apply with a soft cloth and allow to soak.

**NOTE:** The adhesive must be removed from all parts.

**NOTE:** For further cleaning instructions/suggestions, please refer to the Care and Cleaning section.

Parts Diagram

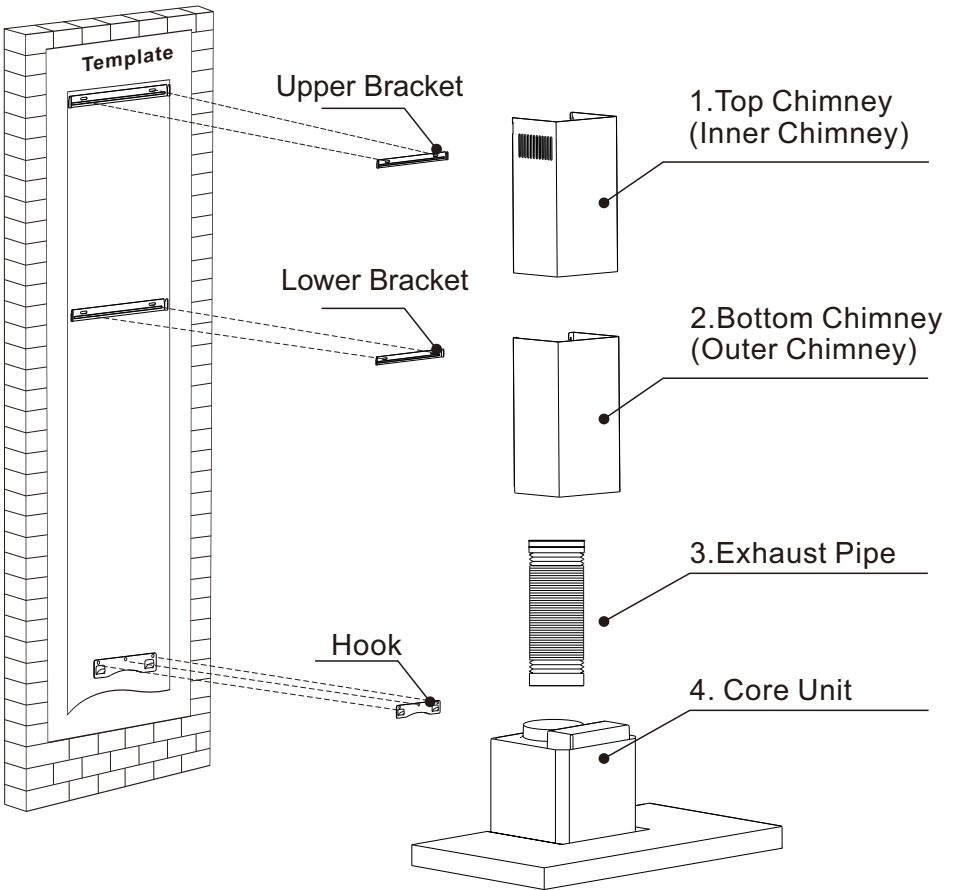

**Parts Supplied**

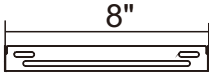

Upper Chimney Bracket

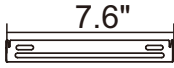

Lower Chimney Bracket



Range Hood Hook



Dampers

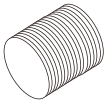

Flexible Pipe

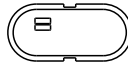

Oil Cup



×9

St4 × 30



×9

φ 5 × φ 8



×2

St3 × 10

**Tools Required**



Pencil

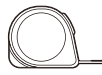

Measuring tape

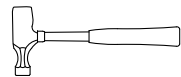

Hammer

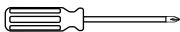

Screwdriver

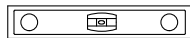

Level



Electric drill

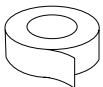

Duct Tape



Gloves

## Installation Instructions

### Prepare for installation:

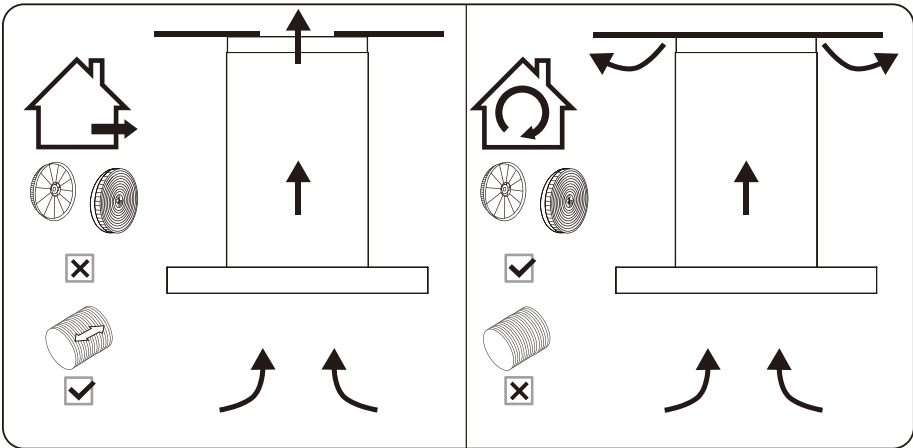

**DUCTED OPTION**

**RECIRCULATION OPTION**

a. If you have an outlet to the outside, your cooker hood can be connected as above picture by means of a pipe (with an interior diameter of 150mm). If you don't have an outlet to the outside, you can go with recirculation mode by using charcoal filters.

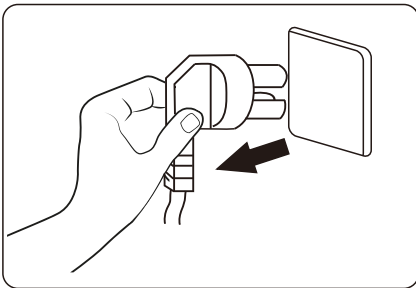

b. Before installation, turn the unit off and unplug it from the outlet.

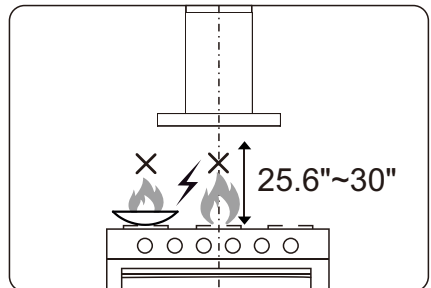

c. The cooker hood should be placed at a distance of 25.6"~30" above the cooktop for the best effect.



No open flames directly approach to the range hood.  
The charcoal filter is not provided, please buy it individually.

## Air Outlet Installation Method

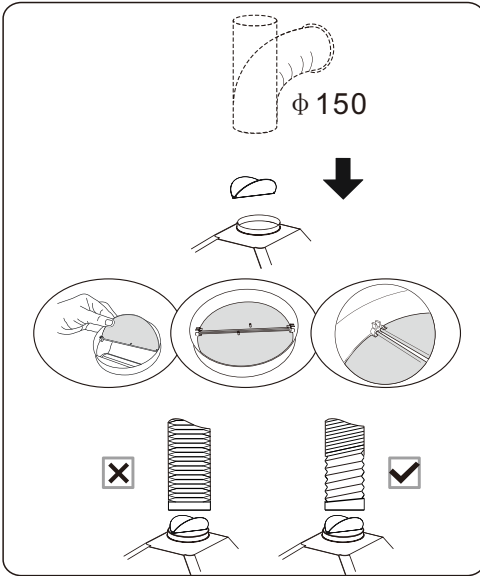

**Installation method for 150mm diameter pipe:** insert the one-way valve as the pic and fix the duct.

**Attention:** The bump of the one-way valve must be upward.

The pipe near the air outlet need to be fully extended.

## Installation

**Note**

Please connect the power supply to test and confirm that the power is on before installing this wall mount range hood.

Refer to the installation instructions:

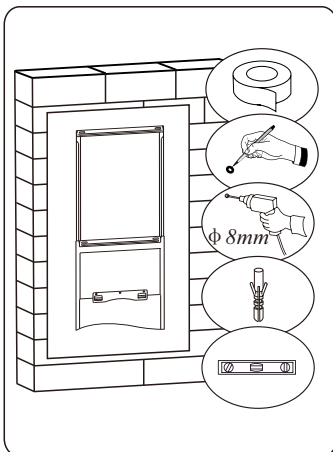

Prepare pencil, electric drill, plastic wall anchors and level before installation.  
 Recommended installation height: 27.6"  
 Required minimum installation height: 25.6"

1. Stick the installation template on the wall.
2. Drill the holes which showing on the template.

**CAUTION:**

Peel off the paper after drilling the holes.  
 The chimney covers height can be adjusted from 500mm to 750mm.

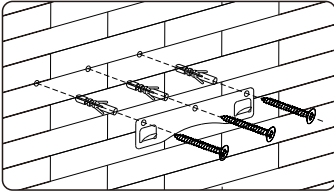

Drill 3 x 8mm holes to accommodate the bracket. Screw and tighten the hook onto the wall with the screws & plastic wall anchors provided.

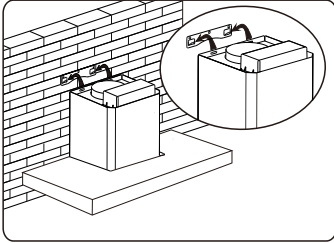

Lift the cooker hood and hang onto the wall hook.

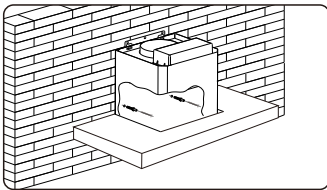

Need to drill 2x8mm extra holes & fixing screws & plastic wall anchors before installation.

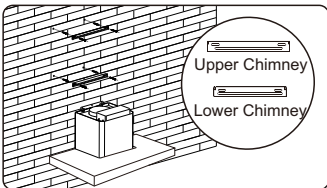

Mark the position and drill 2 holes for each chimney bracket and tighten the bracket with screws.

**i** **Note** The longer bracket is upper chimney bracket

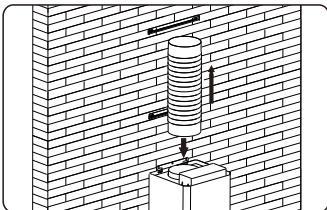

Fix the one-way-value to the air outlet of the cooker hood, and then attached the pipe onto the air outlet as picture.

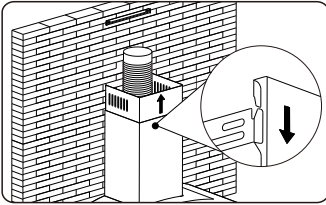

Put the upper chimney into lower chimney . Then pulling out the upper chimney upwards. Adjust to reach the height required.

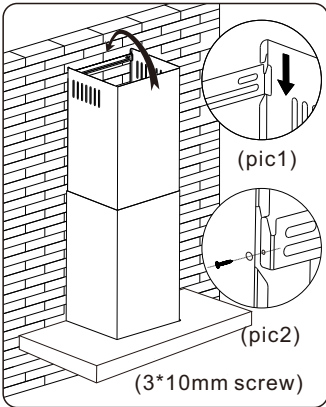

There are 2 methods for installing the chimney cover. Please check the below pic for reference.

1.After drilling the 2 holes and fixing the bracket, hang the chimney cover by matching the both side lock.(Pic1)

2.After drilling the 2 holes and fixing the bracket, install the chimney cover by locking with 2 screws in both side holes.(Pic2)

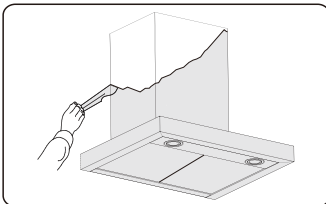

**CAUTION:**

**BEFORE USE**

**Please remove the white/blue protective film on the rangehood,chimney covers and baffle filters.**

## Oil Cup Installation

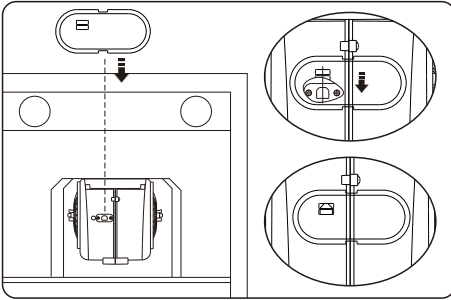

1. Line up Oil Cup.
2. Pull down.
3. Snap into place.

## Operation



- ① **OFF button**  
Turn off the fan.
- ① **Low Speed button**  
Starts the fan at low speed .
- ② **Medium Speed button**  
Starts the fan at medium speed.
- ③ **High Speed button**  
Starts the fan at high speed.
- 💡 **Light button**  
Used for turning on/off the light.

## Maintenance

Before cleaning switch the unit off and pull out the plug.

### I. Regular Cleaning

Use a soft cloth moistened with hand-warm mildly soapy water or household cleaning detergent. Never use metal pads, chemical, abrasive material or stiff brush to clean the unit.

### II. LED Light Replacement

Switch the unit off and unplug the appliance.

**CAUTION:** LAMP UNIT MAY BE HOT!

WAIT UNTIL THE UNIT IS COOL. *BEFORE* attempting to replace the LED lamps make sure the unit is powered off and **UNPLUGGED**.

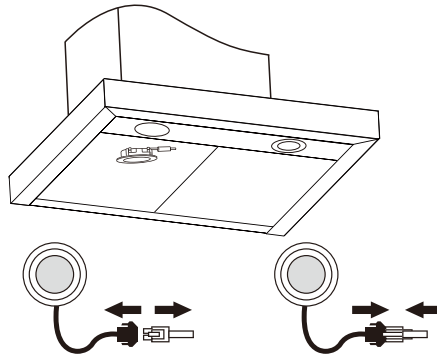

### III. Filter replacement

Clean the filters once a month by hand or in a dishwasher (30 °C). Do not use any acid or corrosive detergents. Do not use any abrasive detergents! Do not use any alkaline dishwasher-detergents! (pH more than 7). Do not put the filter in the dishwasher together with tableware. Filters which are blocked with food debris do not carry a guarantee. Dry the filters properly before you reinstall them.

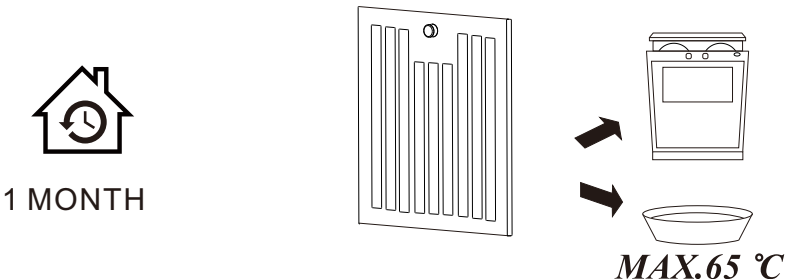

**IV.Charcoal filter life time:** Suggest changing to new one every 3 months (According to different kitchen condition, the life time of charcoal filter might be longer or shorter than 3 months).

**Installation:** Fix carbon filter into the unit and turn it in as below picture shows. Repeat the same on the other side.

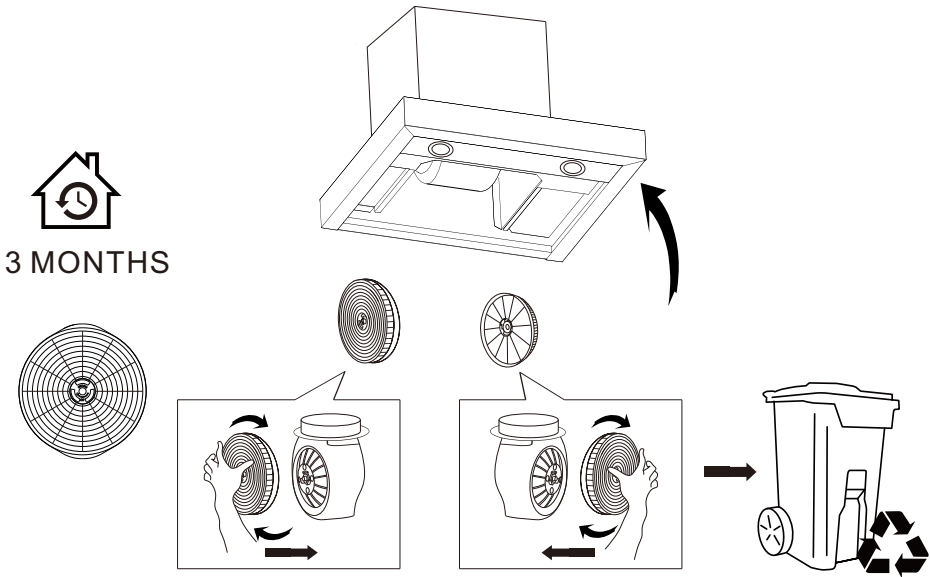

**Important Notice:**

- 1.Make sure the filter is securely locked. Otherwise, it would loosen and cause abnormal noise and danger.
- 2.Using charcoal filter would reduce the air flow of the range hood.
- 3.The charcoal filter is not provided, please buy it individually.

## Trouble-Shooting

Fault	Cause	Solution
Light on, but fan does not work	The fan blade is jammed.	Switch off the unit and repair by qualified service personnel only.
	The motor is damaged.	
Both light and fan do not work	Light is burnt out.	Replace the LED light with correct rating.
	Power cord is loose.	Plug into the power supply again.
Serious Vibration of the unit	The fan blade is damaged.	Switch off the unit and repair by qualified service personnel only.
	The fan motor is not fixed tightly.	
	The unit is not hung properly on the bracket.	Take down the unit and check whether the bracket is in proper location.
Suction performance not good	Too far distance between the unit and the cooktop.	Readjust the distance between 25.6"-30"

## Environmental Protection

Waste electrical products should not be disposed of with household waste. Please recycle where facilities exist. Check with your Local Authority or retailer for recycling advice.



**TRUARCTIC®  
MAJOR APPLIANCE  
LIMITED WARRANTY**

ATTACH YOUR RECEIPT HERE. PROOF OF PURCHASE IS REQUIRED TO OBTAIN WARRANTY SERVICE.

Please write down the product information and have the following information available when you call the Customer Service Center:

- Name, address and telephone number
- Model number
- Serial number
- Purchase Date
- A clear, detailed description of the problem
- Proof of purchase including dealer or retailer name and address



**IF YOU NEED SERVICE:**

Before contacting us to arrange service, please determine whether your product requires repair. Some questions can be addressed without service. Please take a few minutes to review the Troubleshooting or Problem Solver section of the Owner Manual, scan the QR code on the right or visit [www.truarctic.com](http://www.truarctic.com) to access additional resources; or contact your authorized TRUARCTIC dealer for further information.

For one year from the date of purchase, when this major appliance is installed, operated and maintained according to instructions attached to or furnished with the product, TRUARCTIC will pay for Factory Specified Replacement Parts and repair labor to correct defects in materials or workmanship that existed when this major appliance was purchased, or at its sole discretion replace the product. In the event of product replacement, your appliance will be warranted for the remaining term of the original unit's warranty period.

**YOUR SOLE AND EXCLUSIVE REMEDY UNDER THIS LIMITED WARRANTY SHALL BE PRODUCT REPAIR AS PROVIDED HEREIN.** Service must be provided by a TRUARCTIC designated service company. This limited warranty is valid only in Canada and applies only when the major appliance is used in Canada. This limited warranty is effective from the date of original consumer purchase. Proof of original purchase date is required to obtain service under this limited warranty.

**WHAT IS NOT COVERED**

1. Products with original model or serial numbers that have been removed, altered, or cannot be readily determined.
2. Products transferred from the original owner or relocated outside Canada.
3. Products used in commercial, non-residential, multiple-family, or any setting inconsistent with the published user, operator, or installation instructions.
4. Products purchased "as-is," including display models and open-box items.
5. Damage to finish, such as surface rust, tarnish, or small blemishes not reported within 48 hours of delivery.
6. Cosmetic damage including scratches, dents, chips, discoloration, rust, or oxidation resulting from corrosive or caustic environments such as high salt exposure, high humidity, or chemical contact, unless reported within 48 hours of delivery and proven to result from defects in materials or workmanship.
7. Rust and Scratches on any interior or exterior of the hood, back of the filter, and inside the duct cover.
8. Replacement of Consumable parts such as light bulbs, filters, fuses, and oil cups or other cosmetic components.
9. Service calls that do not involve defects in materials or workmanship, including calls to instruct on product use or to correct improper installation or maintenance.
10. Service calls required to correct installation not performed according to applicable electrical or plumbing codes, or to repair household electrical or plumbing issues such as house wiring, fuses, or water inlet hoses.
11. Costs incurred to make the appliance accessible for servicing, including removal or reinstallation of trim, cabinetry, decorative panels, flooring, islands, countertops, drywall, or other built-in fixtures.
12. Transportation, pick-up, delivery, travel charges, tolls, ferry fees, or service calls to remote locations
13. Damage to property such as floors, cabinets, or walls incurred during installation, removal, or servicing of the product.
14. Repairs or damage caused by unauthorized service providers or use of non-genuine manufacturer parts.
15. Alteration, modification, or unauthorized repairs to the appliance.
16. Damage resulting from misuse, abuse, accidents, inadequate power supply, fire, flood, or other external causes including acts of God.

**The cost of repair or replacement under these excluded circumstances shall be borne by the customer.**

**DISCLAIMER OF IMPLIED WARRANTIES**

IMPLIED WARRANTIES, INCLUDING ANY IMPLIED WARRANTY OF MERCHANTABILITY OR IMPLIED WARRANTY OF FITNESS FOR A PARTICULAR PURPOSE, ARE LIMITED TO ONE YEAR OR THE SHORTEST PERIOD ALLOWED BY LAW. Some provinces do not allow limitations on the duration of implied warranties of merchantability or fitness, so this limitation may not apply to you. This warranty gives you specific legal rights, and you also may have other rights that vary from state to state or province to province.

**DISCLAIMER OF REPRESENTATIONS OUTSIDE OF WARRANTY**

TRUARCTIC makes no representations about the quality, durability, or need for service or repair of this major appliance other than the representations contained in this warranty. If you want a longer or more comprehensive warranty than the limited warranty that comes with this major appliance, you should ask TRUARCTIC or your retailer about buying an extended warranty.

**LIMITATION OF REMEDIES; EXCLUSION OF INCIDENTAL AND CONSEQUENTIAL DAMAGES**

**YOUR SOLE AND EXCLUSIVE REMEDY UNDER THIS LIMITED WARRANTY SHALL BE PRODUCT REPAIR AS PROVIDED HEREIN. TRUARCTIC SHALL NOT BE LIABLE FOR INCIDENTAL OR CONSEQUENTIAL DAMAGES.** Some provinces do not allow the exclusion or limitation of incidental or consequential damages, so these limitations and exclusions may not apply to you. This warranty gives you specific legal rights, and you also may have other rights that vary from state to state or province to province.

®/™ ©2025 Truarctic. Used under license in Canada. All rights reserved.  
Utilisé sous licence au Canada. Tous droits réservés.