



30" (76.2 cm) Freestanding Electric Range

PRODUCT MODEL NUMBERS

WFE715H0E

Electrical: To properly install your range, you must determine the type of electrical connection you will be using and follow the instructions provided for it here.

- Range must be connected to the proper electrical voltage and frequency as specified on the model/serial number rating plate. The model/serial number rating plate is located on the left side frame behind the storage drawer panel or behind the top right side of the oven door. Refer to the figures in the "Product Dimensions" section of the "Location Requirements" section.
- This range is manufactured with the neutral terminal connected to the cabinet. Use a 3-wire, UL listed, 40- or 50-amp power supply cord (pigtail) (see following Range Rating chart). If local codes do not permit ground through the neutral, use a 4-wire power supply cord rated at 250 volts, 40 or 50 amps and investigated for use with ranges.

Range Rating*		Specified Rating of Power Supply Cord Kit and Circuit Protection
120/240 Volts	120/208 Volts	Amps
8.8 – 16.5 KW	7.8 – 12.5 KW	40 or 50 **
16.6 – 22.5 KW	12.6 – 18.5 KW	50

* The NEC calculated load is less than the total connected load listed on the model/serial rating plate.

** If connecting to a 50-amp circuit, use a 50-amp rated cord with a kit. For 50-amp rated cord kits, use kits that specify use with a nominal 1³/₈" (34.9 mm) diameter connection opening.

- A circuit breaker is recommended.

CABINET OPENING DIMENSIONS

Cabinet opening dimensions shown are for 25" (64.0 cm) countertop depth, 24" (61.0 cm) base cabinet depth and 36" (91.4 cm) countertop height.

IMPORTANT: If installing a range hood or microwave hood combination above the range, following the range hood or microwave hoods combination instructions for dimensional clearances above the cooktop surface.

A freestanding range may be installed next to combustible walls with zero clearance.

***NOTE:** 24" (61.0 cm) minimum when bottom of wood or metal cabinet is covered by not less than 1/4" (0.64 cm) flame retardant millboard covered with not less than No. 28 MSG sheet steel, 0.015" (0.4 mm) stainless steel, 0.024" (0.6 mm) aluminum or 0.020" (0.5 mm) copper.

PRODUCT DIMENSIONS

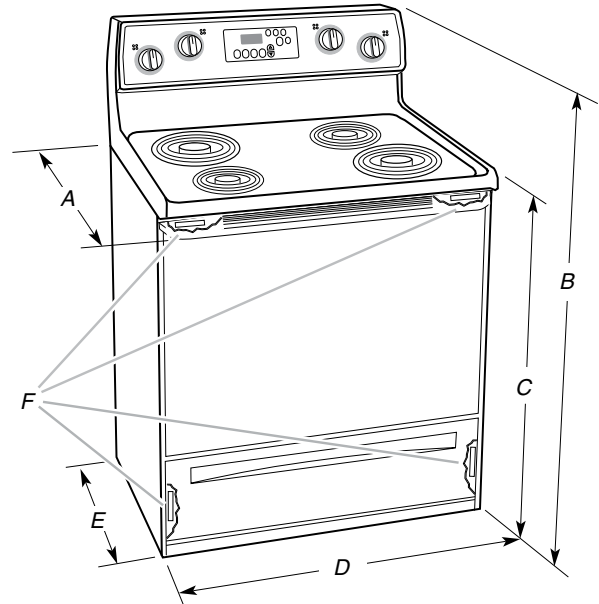

- A. 27³/₄" (70.5 cm) max. depth with handle
- B. 46⁷/₈" (119.1 cm) overall height (max.) with leveling legs screwed all the way in*
- C. 36" (91.4 cm) cooktop height (max.) with leveling legs screwed all the way in*
- D. 29⁷/₈" (75.9 cm) width
- E. 25⁵/₁₆" (64.3 cm) depth – back of range to front of cooktop**
- F. Model/serial rating plate (located on the left side frame behind storage drawer or right side of frame behind the oven door)

IMPORTANT: Range must be level after installation. Follow the instructions in the "Level Range" section. Using the cooktop as a reference for leveling the range is not recommended.

* Range can be raised approximately 1" (2.5 cm) by adjusting the leveling legs.

** Front of door and drawer may extend further forward depending on styling.

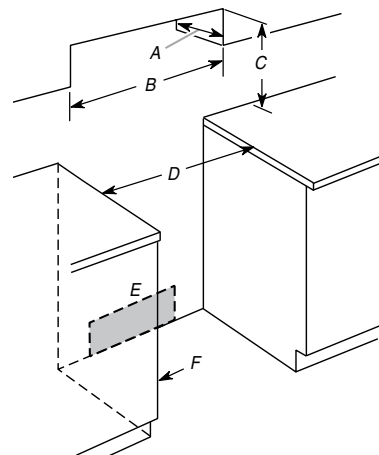

- A. 13" (33.0 cm) max. upper cabinet depth
- B. 30" (76.2 cm) min. opening width
- C. For minimum clearance to top of cooktop, see NOTE
- D. 30¹/₈" (76.5 cm) min opening width
- E. Outlet – 8" (20.3 cm) to 22" (55.9 cm) from either cabinet, 5¹/₂" (14.0 cm) max. to floor
- F. Cabinet door or hinges should not extend into the cutout