



Electric Dryer

PRODUCT MODEL NUMBERS

WED5500B, WED5800B,
WED5810B

Front view:

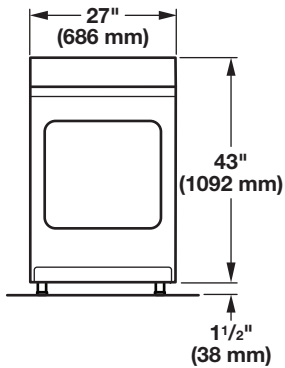

Side view:
Wide opening side-swing
door

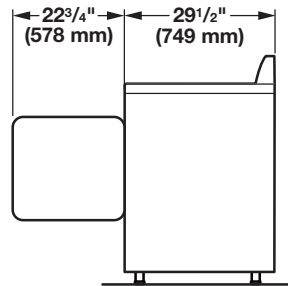

Side view:
Wide opening hamper
door

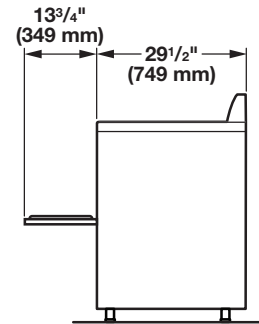

* Most installations require a minimum 5 1/2" (140 mm) clearance behind the dryer for the exhaust vent with elbow See "Venting Requirements."

Minimum required spacing:

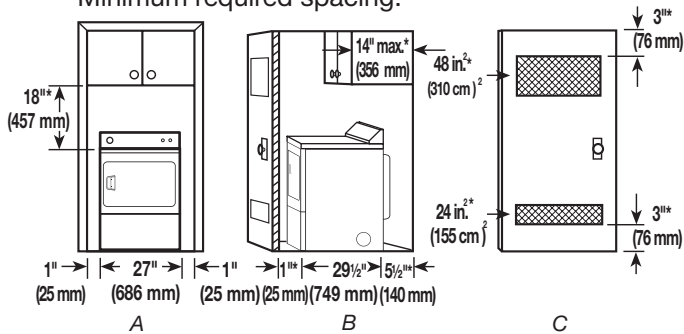

- A. Recessed area
- B. Side view - closet or confined area
- C. Closet door with vents

*Additional spacing recommended

Installation spacing for recessed area or closet installation

The dimensions shown below are the recommended spacing for this dryer.

- Additional spacing should be considered for ease of installation and servicing.
- Additional clearances might be required for wall, door, floor moldings, and dryer venting.
- Additional spacing of 1" (25 mm) on all sides of the dryer is recommended to reduce noise transfer.
- For closet installation, with a door, minimum ventilation openings in the top and bottom of the door are required. Louvered doors with equivalent ventilation openings are acceptable. Companion appliance spacing should also be considered.

ELECTRICAL REQUIREMENTS

To supply the required 3 or 4 wire, single phase, 120/240 volt, 60 Hz., AC only electrical supply (or 3 or 4 wire, 120/208 volt electrical supply, if specified on the serial/rating plate) on a separate 30-amp circuit, fused on both sides of the line. A time-delay fuse or circuit breaker is recommended. Connect to an individual branch circuit.

VENTING REQUIREMENTS

Exhaust venting: Exhaust your dryer to the outside. 4" (102 mm) diameter vent is required. Rigid or flexible metal exhaust vent must be used. Do not use plastic or metal foil vet. Exhaust hood must be at least 12" (305 mm) from the ground or any object that may be in the path of the exhaust.

Exhaust hoods:

Recommended Styles:

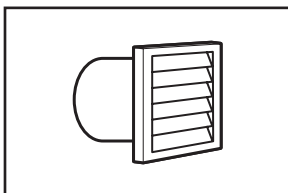

Louvered Hood

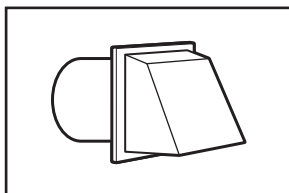

Box Hood

Acceptable Style:

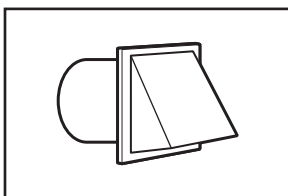

Angled Hood

Determine vent path:

- Select route that will provide straightest and most direct path outdoors.
- Plan installation to use fewest number of elbows and turns.
- When using elbows or making turns, allow as much room as possible.
- Bend vent gradually to avoid kinking.
- Use as few 90° turns as possible.

Determine vent length and elbows needed for best drying performance:

- Use following Vent System Chart to determine type of vent material and hood combinations acceptable to use.

NOTE: Do not use vent runs longer than those specified in Vent System Chart. Exhaust systems longer than those specified will:

- Shorten life of dryer.
- Reduce performance, resulting in longer drying times and increased energy usage.

The Vent System Chart provides venting requirements that will help achieve best drying performance.

Vent System Chart			
Number of 90° turns or elbows	Type of vent	Box/louvered hoods	Angled hoods
0	Rigid metal	64 ft. (20 m)	58 ft. (17.7 m)
1	Rigid metal	54 ft. (16.5 m)	48 ft. (14.6 m)
2	Rigid metal	44 ft. (13.4 m)	38 ft. (11.6 m)
3	Rigid metal	35 ft. (10.7 m)	29 ft. (8.8 m)
4	Rigid metal	27 ft. (8.2 m)	21 ft. (6.4 m)

NOTE: Side and bottom exhaust installations have a 90° turn inside the dryer. To determine maximum exhaust length, add one 90° turn to the chart.