

ACT™

	INTERNAL BLOWER STANDARD	INTERNAL BLOWER with ACT™ AIRFLOW CONTROL TECHNOLOGY™*	
Min. - Max. CFM	450 - 1,200	350 - 590	350 - 390
Min. - Max. Sones	3.5 - 9	*AIRFLOW CONTROL TECHNOLOGY™ (ACT™) is an exclusive feature built into specific Zephyr hoods which can limit the maximum blower CFM to meet local code requirements.	

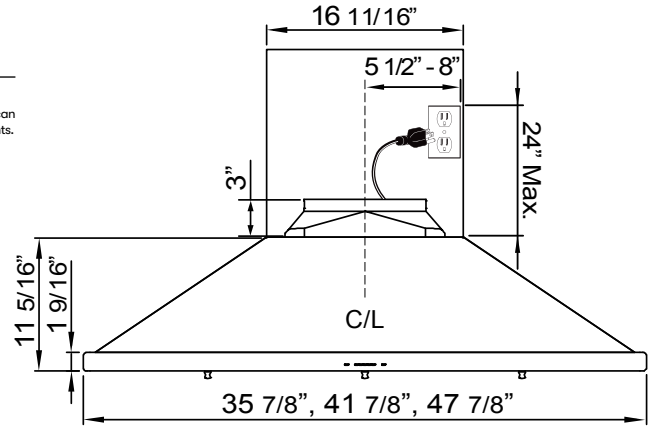

48" model



FRONT

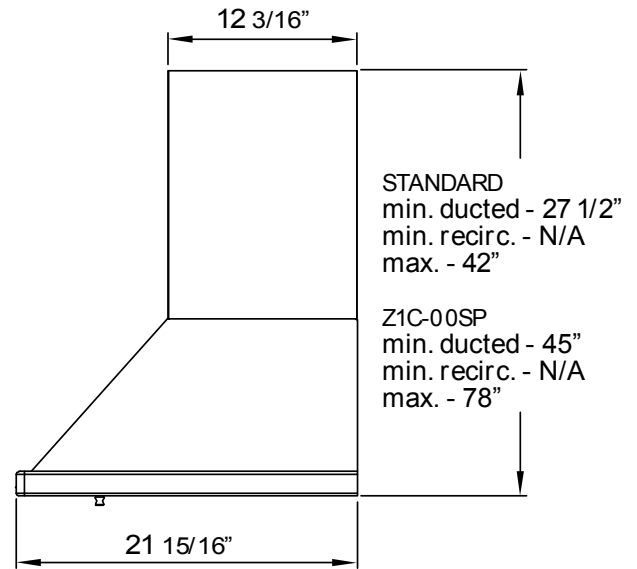

SIDE

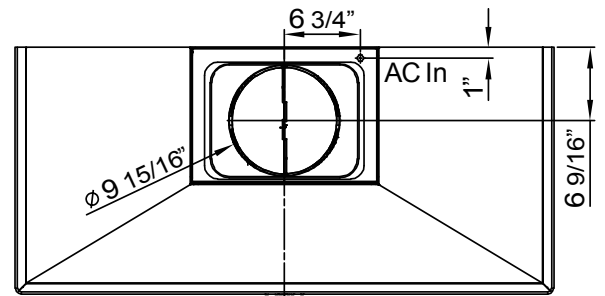

C/L

TOP

MODEL			
Stainless Steel	ZSP-E36CS	ZSP-E42CS	ZSP-E48CS
Size	36"	42"	48"
BLOWER PERFORMANCE			
Blower CFM (Min. - Max.)	450 - 1,200	450 - 1,200	450 - 1,200
Sones (Min. - Max.)	3.5 - 9	3.5 - 9	3.5 - 9
ACT 590 CFM (Min. - Max.)	350 - 590	350 - 590	350 - 590
ACT 390 CFM (Min. - Max.)	350 - 390	350 - 390	350 - 390
FEATURES			
ACT™ Technology	590, 390	590, 390	590, 390
Controls	ICON Touch®	ICON Touch®	ICON Touch®
Speed Levels	5*	5*	5*
Auto Delay-Off	Yes	Yes	Yes
Lighting	LumiLight LED, 6W x2	LumiLight LED, 6W x2	LumiLight LED, 6W x2
Dual-Level Lighting	Yes	Yes	Yes
Filters	Hybrid Baffles x2	Hybrid Baffles x2	Hybrid Baffles x3
Recirculating Option	No	No	No
Extension Duct Cover Option	Yes, Up to 12' Ceiling	Yes, Up to 12' Ceiling	Yes, Up to 12' Ceiling
ADA Compliant	Yes, w/ remote accessory	Yes, w/ remote accessory	Yes, w/ remote accessory
DUCT SPECIFICATIONS			
Vertical Internal Blower	10" Round	10" Round	10" Round
Horizontal Internal Blower	NA	NA	NA
AC POWER	120V, 60Hz at Max. 9A	120V, 60Hz at Max. 9A	120V, 60Hz at Max. 9A
OPTIONAL ACCESSORIES			
Wireless Remote Control Kit	RC-0002	RC-0002	RC-0002
Extension Duct Cover	Z1C-00SP	Z1C-00SP	Z1C-00SP
Stainless Steel Telescopic Backsplash	AK1716	AK1712	AK1718
Make-Up Air Kit	MUA010A	MUA010A	MUA010A
MOUNTING HEIGHT RANGE**	26" - 34"	26" - 34"	26" - 34"
WARRANTY	3 years parts, 1 year labor	3 years parts, 1 year labor	3 years parts, 1 year labor

CEILING HEIGHT		8'	8.5'	9'	9.5'	10'	10.5'	11'	12'
STANDARD DUCT COVER	Ducted Mounting Height*	26" - 32.5"	26" - 34"	30" - 34"	NA	NA	NA	NA	NA
EXTENSION DUCT COVER	Ducted Mounting Height*	NA	NA	26" - 27"	26" - 33"	26" - 34"	26" - 34"	26" - 34"	30" - 34"

*When ACT™ is enabled the maximum speed levels will change. ACT 590 CFM = 3 speeds and ACT 390 CFM = 2 speeds.

**Mounting height refers to distance between top of a 36" tall cooking surface and bottom of hood.

ACT™ Airflow Control Technology™ (ACT™) is an exclusive feature built into specific Zephyr hoods which can limit the maximum blower CFM to meet local code requirements.

Specifications subject to change, check zephyronline.com for up-to-date information.
Zephyr Ventilation | 2277 Harbor Bay Parkway, Alameda, CA 94502 | 888.880.VENT

APR22.0101

